

Heavy Duty Connectors RockStar®

The entire
product and
service world under:
catalog.weidmueller.com

Version 2022



Weidmüller 

Orange Selection

Quick and easy planning

As a planning engineer, do you want to select products easily and receive them quickly? From a partner you can rely on? Then plan with the Orange Selection from Weidmüller in the future. The Orange Selection items are always available, carefully selected and the portfolio consists of more than 1,500 items to fully cover your standard needs.

If your order is placed before 3:00 pm, we guarantee that your order will be on its way the very next working day.

For even more efficient planning and production processes, we will of course provide all articles in digital form. CAD, ETIM and eClass data are available in our online product catalogue **catalog.weidmueller.com**

We have summarised all the advantages of the Orange Selection on our website.

Check it out: **www.weidmueller.com/orange-selection**



Heavy Duty Connectors – RockStar®

Catalogue 3

Heavy Duty Connectors – RockStar®

Overview

RockStar® inserts

RockStar® ModuPlug modular system

RockStar® Housings IP65 / NEMA Type 12, 4X

RockStar® Housings IP65 / EMC

RockStar® Housings IP66 / IP68 / EMC

RockStar® Wall mounting housing IP66

RockStar® HighPower

RockStar® Kits

RockStar® accessories, tools and cable glands

Appendix

Service and support

Index

Search according to type or order number,
Addresses worldwide

Heavy Duty Connectors – RockStar®

RockStar® inserts Page B.2



RockStar® ModuPlug modular system Page C.2



RockStar® Housings IP65 / NEMA Type 12, 4X Page D.2



RockStar® Housings IP65 / EMC Page E.2



RockStar® Housings IP66 / IP68 / EMC Page F.2



RockStar® Wall mounting housing IP66 Page G.2



RockStar® HighPower Page H.2

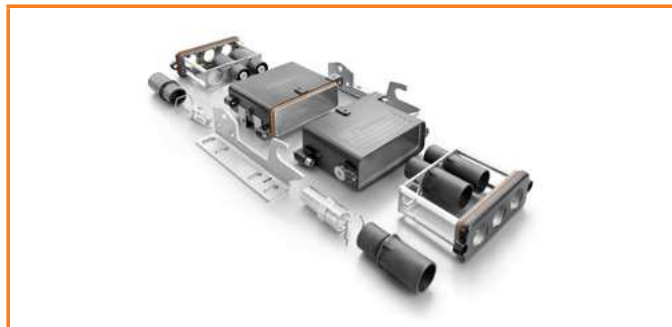

RockStar® Kits Page I.2



Heavy Duty Connectors – RockStar®

RockStar® accessories, tools and cable glands Page J.2



Overview

Overview	Construction of heavy-duty connectors - fixed pole	A.2
	Part codes for inserts	A.3
	Overview of size 1 - fixed pole	A.4
	Overview of sizes 2, 5, 7, 9 - fixed pole	A.5
	Overview of sizes 3, 4, 6, 8, 10, 12 - fixed pole	A.6
	Overview of size HQ - fixed-pole	A.8
	Construction of heavy-duty connectors - modular	A.9
	Overview of sizes 3, 4, 6, 8, 10, 12 - modular	A.10
	Connection technologies	A.12
	Crimp contacts	A.18
	Using wire-end ferrules	A.20
	Tightening torques and screwing tools	A.21
	Torque housing	A.22
	RockStar® - Housing types	A.24
	Locking systems	A.28
	Part codes for housings IP65	A.29
	Part codes for covers	A.30
	Part codes for housings IP68	A.31
	Panel cut-out	A.32
	Electrical data	A.34
	Electromagnetic compatibility (EMC)	A.38
	Classes of protection	A.41
	Chemical resistance	A.43
	Safety information and standards	A.44

Construction of heavy-duty connectors – fixed pole

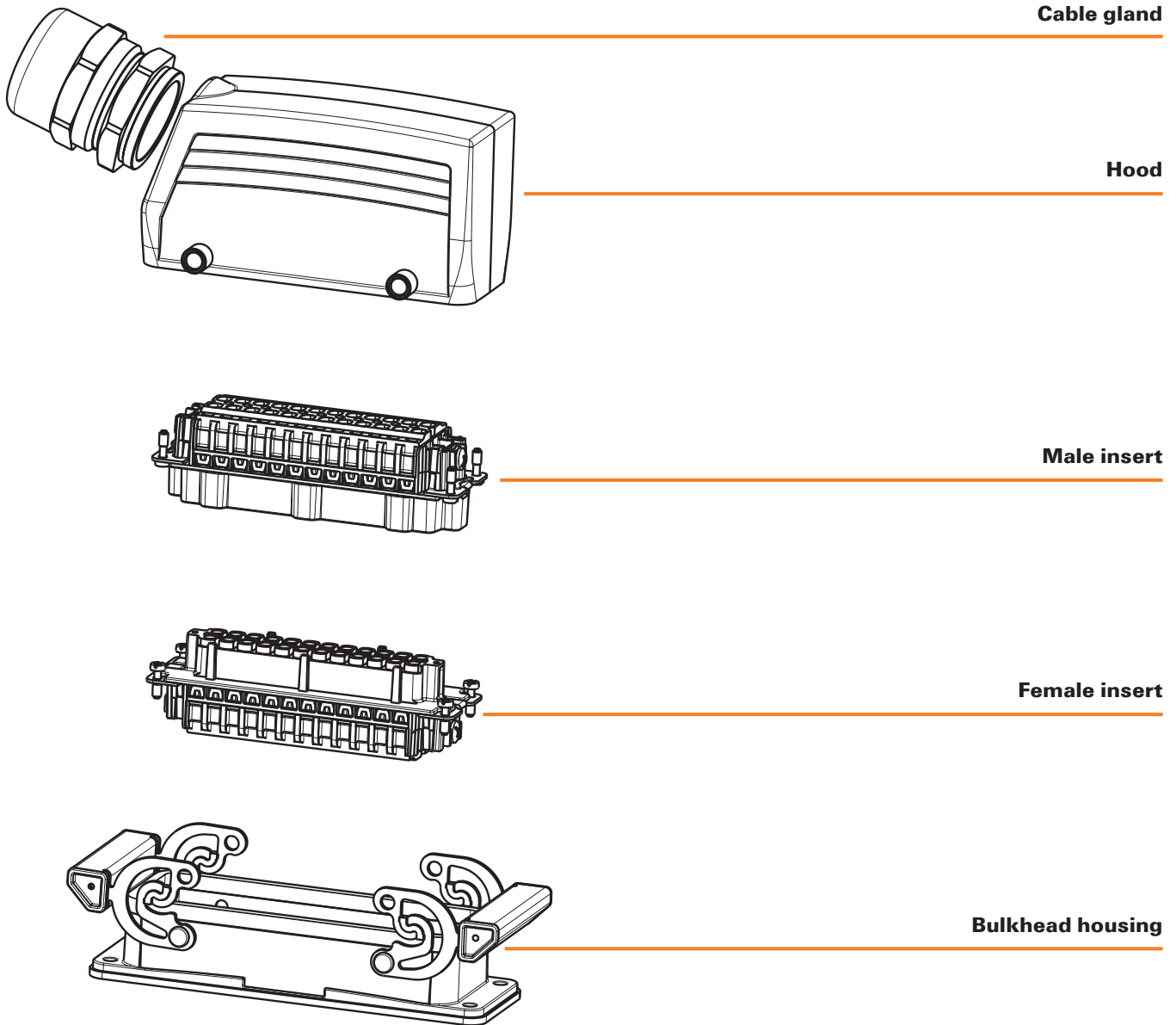

Part codes for inserts

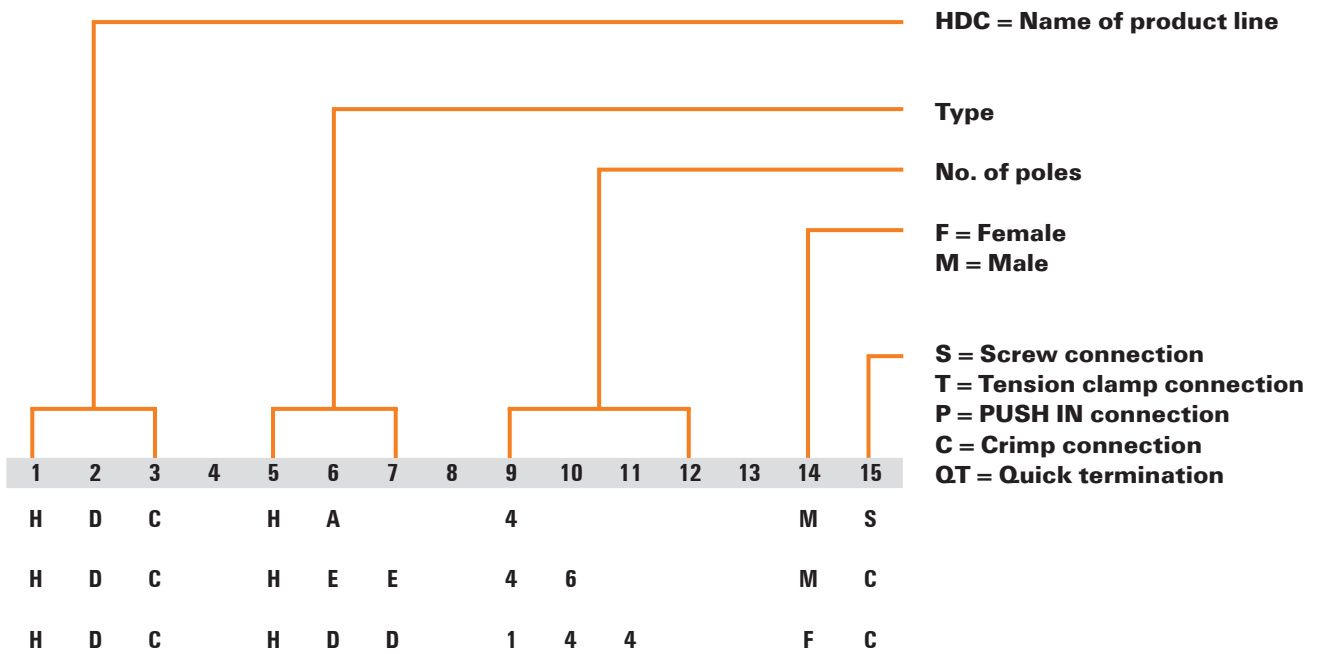

Overview of size 1 – fixed pole

Size

1

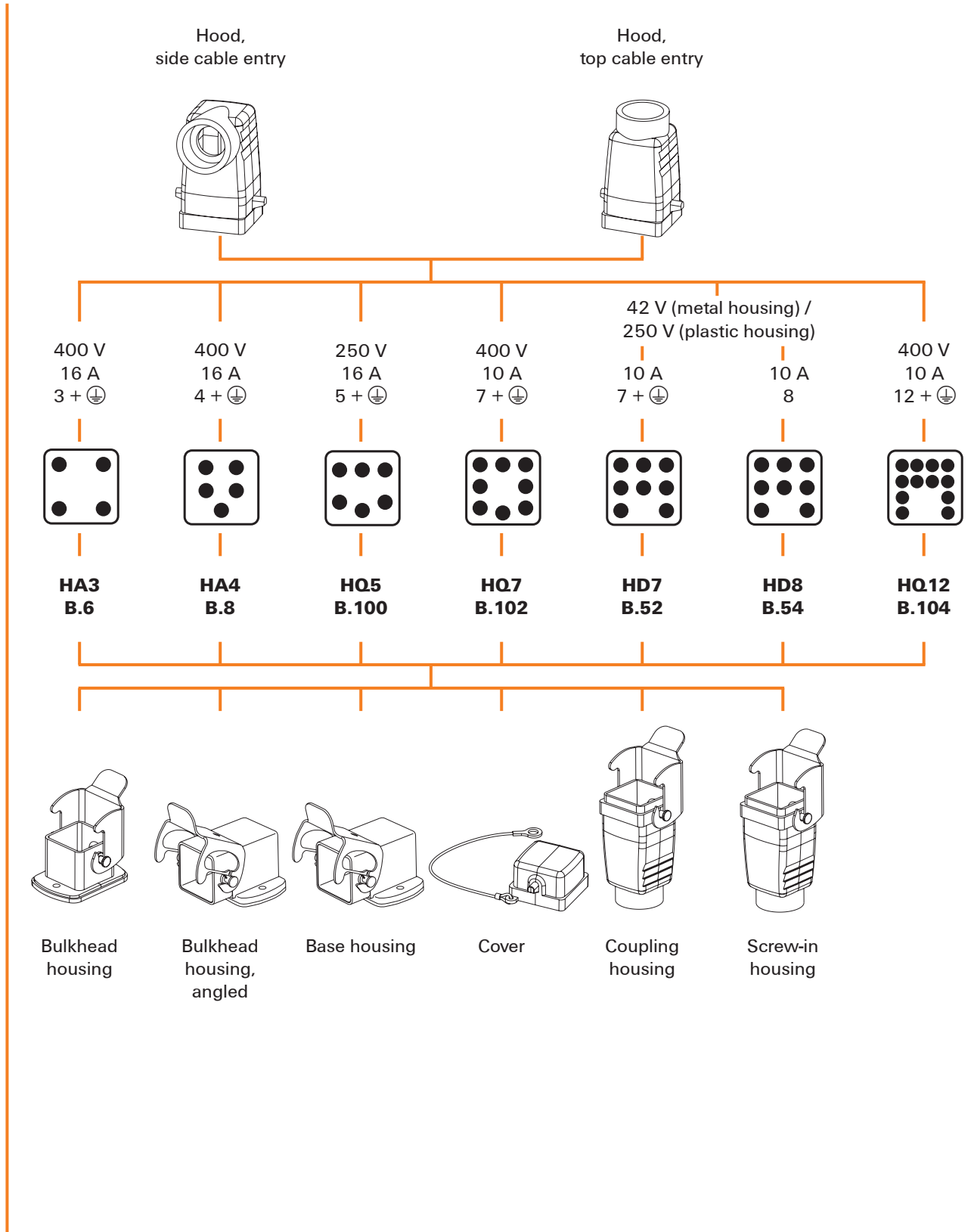

Overview of sizes 2, 5, 7, 9 – fixed pole

Size

Hood, side cable entry

Hood, top cable entry

2

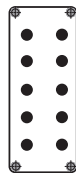
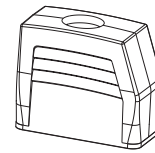
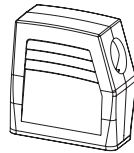

250 V
16 A
10 + ⊕

HA10
B.10



250 V
10 A
15 + ⊕

HD15
B.56

5

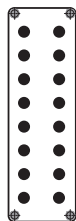

250 V
16 A
16 + ⊕

HA16
B.12



250 V
10 A
25 + ⊕

HD25
B.58

7

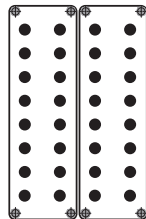

250 V
16 A
32 + ⊕

HA32
B.14

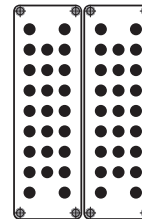

250 V
10 A
50 + ⊕

HD50
B.62

9

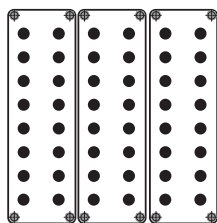

250 V
16 A
48 + ⊕

HA48
B.16

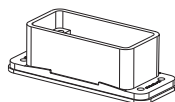

Bulkhead housing

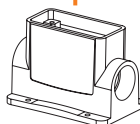

Base housing



Coupling housing

Overview of sizes 3, 4, 6, 8, 10, 12 – fixed pole

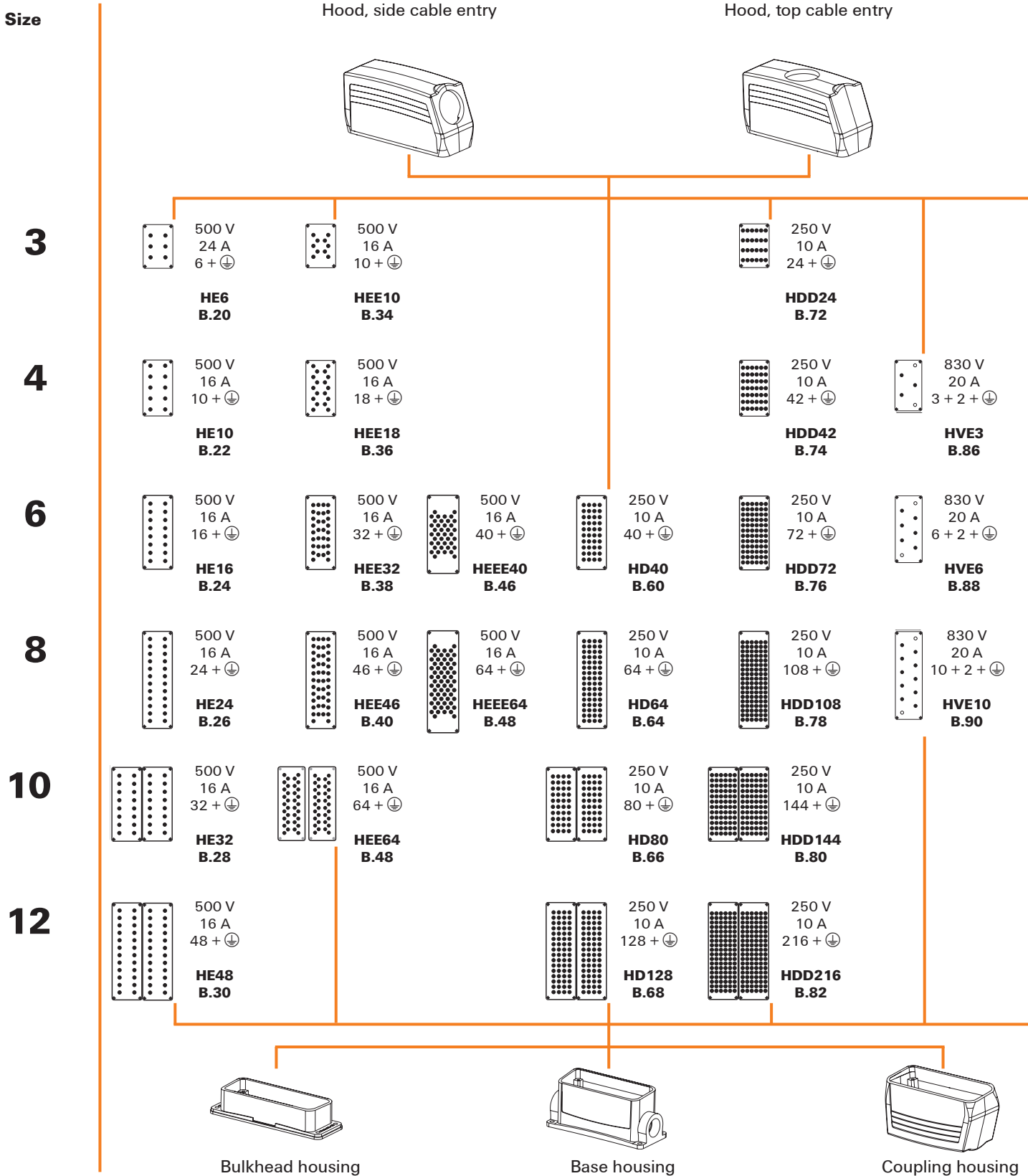

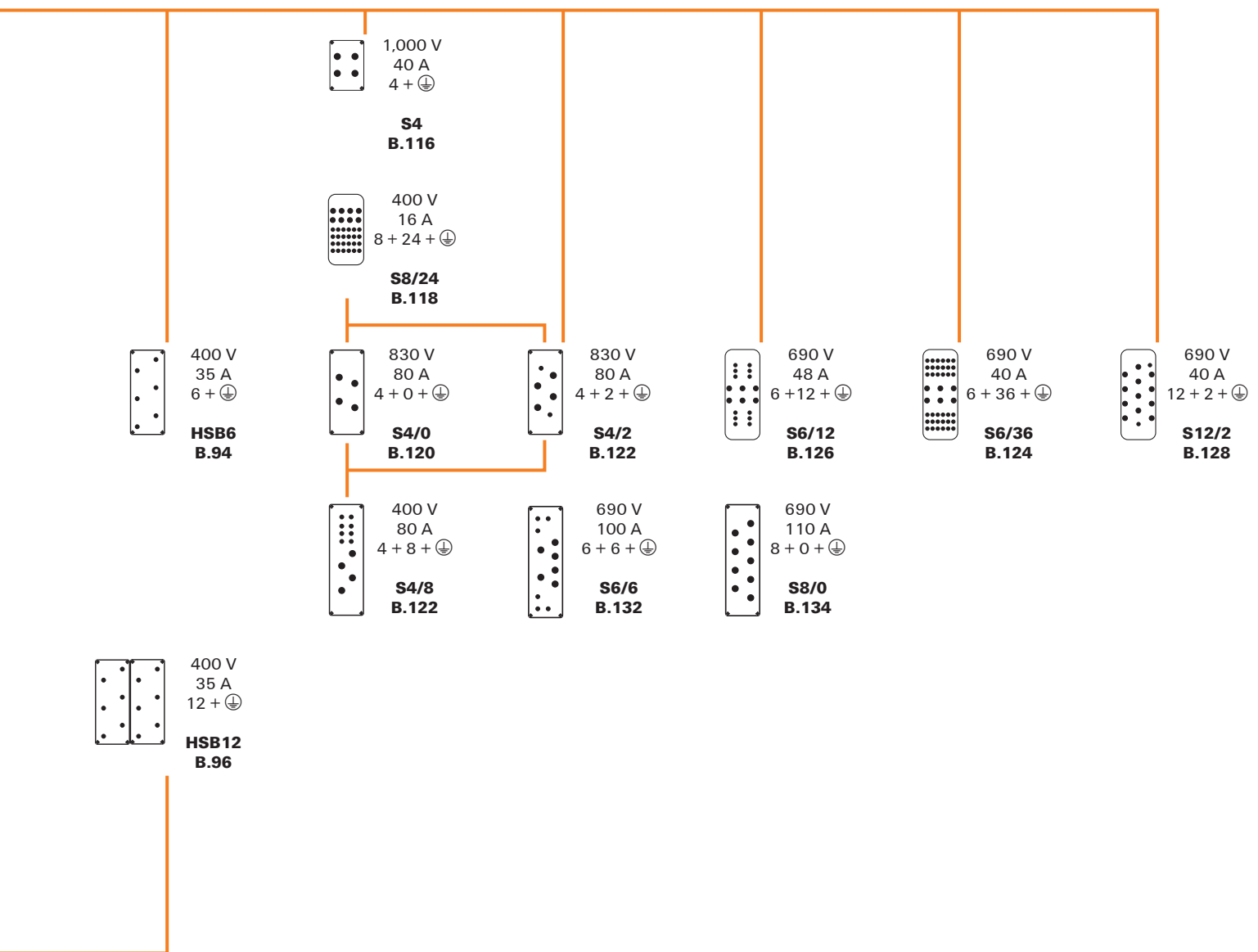

Overview of size HQ – fixed-pole

Size

HQ

Hood, side cable entry

Hood, top cable entry

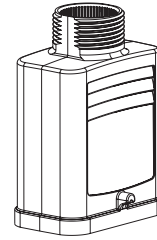
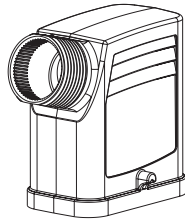

500 V
16 A
8 + ⊕

250 V
10 A
17 + ⊕

690 V / 250 V
10 A / 40 A
4 + 2 + ⊕



HQ8
B.106

HQ17
B.108

HQ4/2
B.110

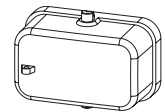
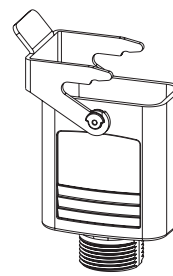
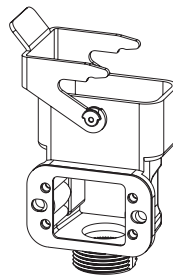
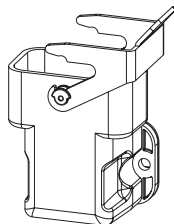
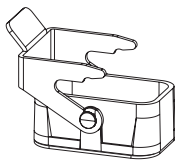

Bulkhead housing

Bulkhead housing, angled

Base housing

Coupling housing

Cover

Construction of heavy-duty connectors – modular



Cable gland

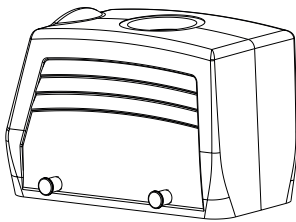

Hood

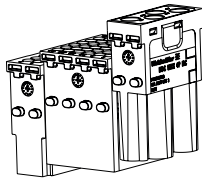

Male Modular Insert

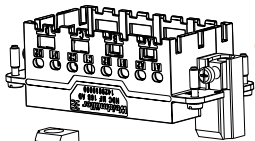

Male frame

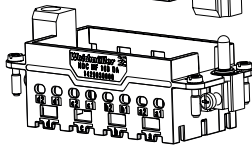

Female frame

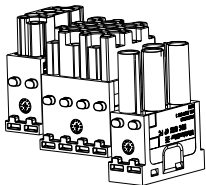

Female Modular Insert

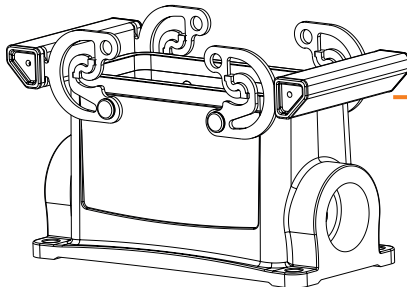

Base housing

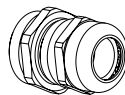
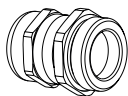

Cable glands

Overview of sizes 3, 4, 6, 8, 10, 12 – modular

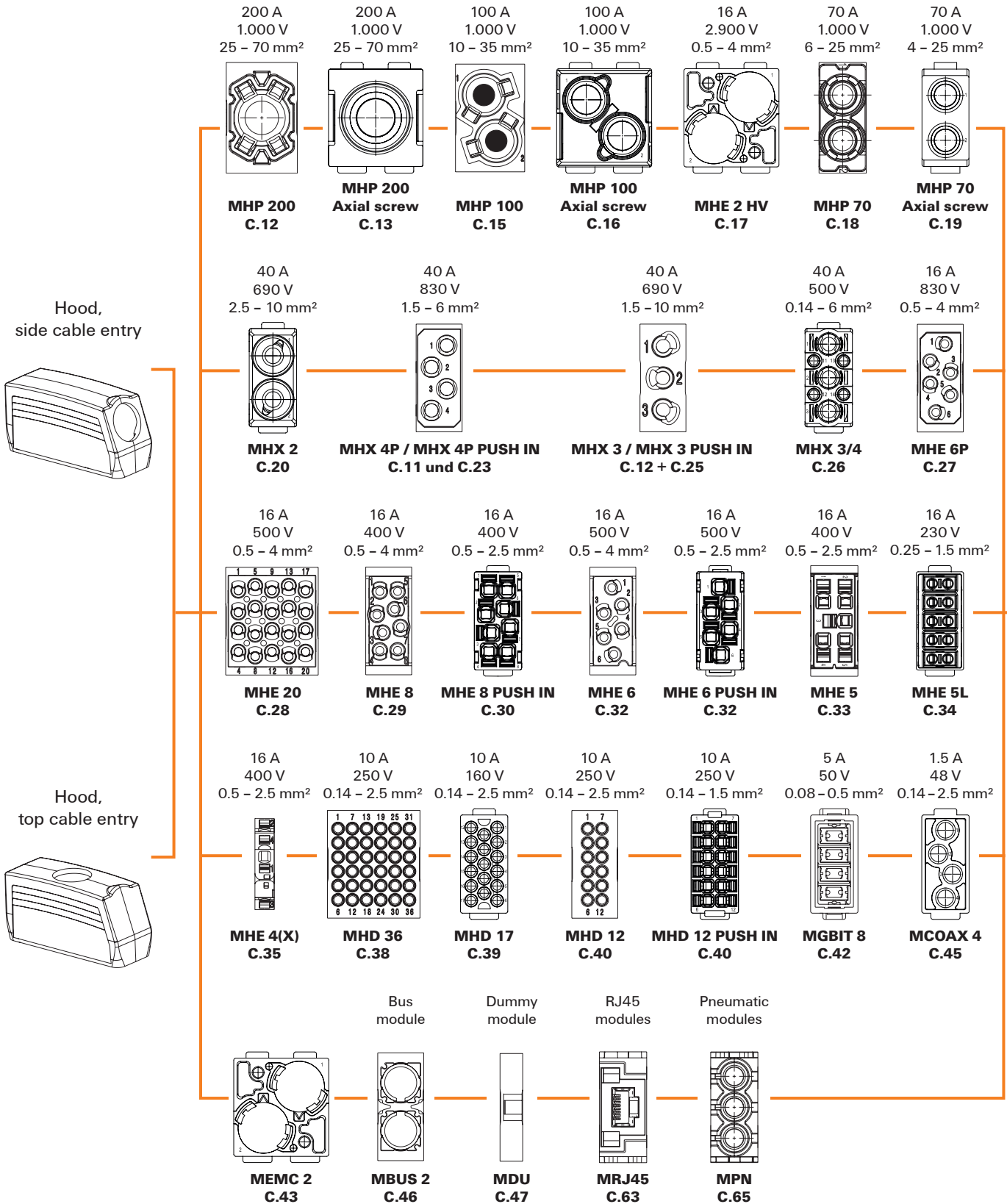

Size

3

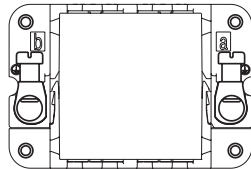

MF 6B
for 2 modules
C.8

4

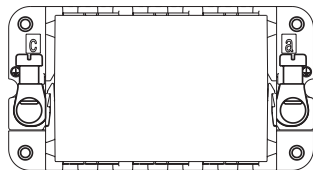

MF 10B
for 3 modules
C.9

6

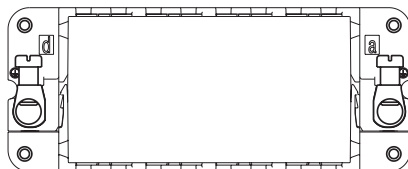

MF 16B
for 4 modules
C.10

8

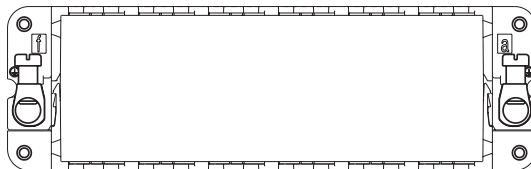

MF 24B
for 6 modules
C.11

10

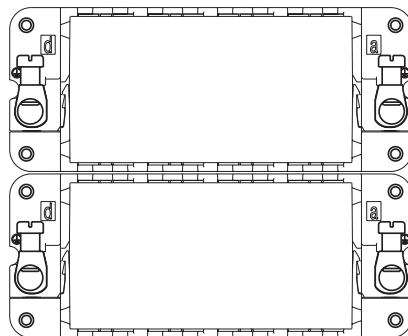

2 x MF 16B
for 8 modules
C.7

12

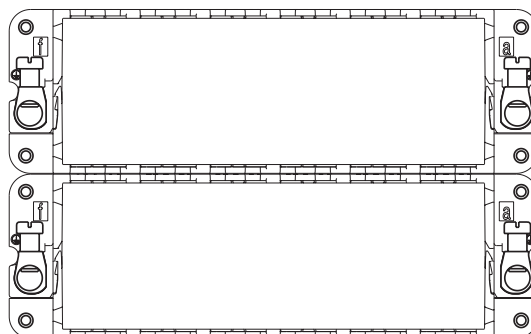

2 x MF 24B
for 12 modules
C.7

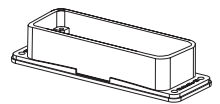

Bulkhead housing

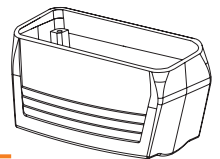

Coupling housing

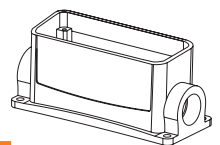

Base housing

Wiring close to the application

RockStar® always offers the right connection technology

SNAP IN 

PUSH IN 

Spring connection with SNAP IN technology



The innovative SNAP IN technology is revolutionizing control cabinet construction. The direct plugging of flexible conductors without a wire end ferrule thereby reduces conductor

preparation and wiring.

Connection principle:

- Significant acceleration of installation and maintenance processes in the field.
- Tool-free, material- and time-saving, as crimping on ferrules is no longer necessary
- Simply insert the flexible stranded conductor into the open connection point until it „clicks“
- Secure connection that reliably withstands even strong impacts and vibrations

Field of application:

Wherever flexible conductors without ferrules are used, SNAP IN technology offers the decisive handling advantage. Especially in industries with an increased volume of signal cables.

Spring connection with PUSH IN technology



The PUSH IN spring connection with direct plug-in technology enables the fastest wiring process: The stripped or prepared conductor is simply inserted into the clamping point as far as it will go - and that's it. Operating the release lever is only necessary for highly flexible stranded wires or to release the connection. The stainless steel spring guarantees a high contact force of the conductor on the tinned copper busbar. An enclosing stainless steel cage prevents settling in the contact area. Supporting the clamping force on plastic parts was deliberately omitted.

Connection principle:

- Convenient, vibration-proof and gas-tight connection.
- Fine-stranded conductors with crimped-on ferrules, solid conductors or ultrasonically welded conductors simply inserted into the clamping point as far as it will go
- Spring and conductor stop ensure optimum connection conditions and guidance of the screwdriver to release the conductor.

Field of application:

The standard connector for applications in the field where fast wiring in combination with small dimensions is required and intuitive use is an advantage. Also in environmental conditions with strong vibration.

Spring connection with tension spring technology



The pretensioned tension spring made of high-quality stainless and acid-resistant steel pulls the conductor against the galvanized copper busbar, creating a permanently good vibration-resistant connection. The spring is opened by means of a screwdriver. The conductor is pushed into the spring cage via the conductor insertion funnel. The conductor is clamped by removing the screwdriver. Low contact resistance and high corrosion resistance are achieved by the surface-treated busbar.

Connection principle:

- Low contact resistance and high corrosion resistance.
- Tension spring made of high-quality, rust- and acid-resistant steel pulls the conductor against the tinned copper busbar
- Insensitive to vibrations and high conductor pull-out forces

Field of application:

For fast wiring with constant conductor clamping force, even in ambient conditions with strong vibration.

Screw connection



The simple handling makes the screw connection the universal screwed connection solution for all conductor types.

Connection principle:

- The screw connection is the best known connection technology worldwide
- The built-in wire protection spring protects the conductor from damage
- Screw terminals are being replaced by PushIn terminals in many places

Field of application:

For fast wiring with constant conductor clamping force, even in ambient conditions with strong vibration.

Wiring close to the application

RockStar® always offers the right connection technology.

TOP screw termination with pull effect



Whereas with the classic screw connection the screw is always arranged at right angles to the conductor outlet direction, the TOP connection allows operation from the conductor direction.

The TOP connection thus enables the greatest possible packing density in the connection area. The „pull effect“ ensures that when the conductor is connected, it is pulled into the clamping point and makes secure contact.

Connection principle:

- Parallelism of conductor entry and screw actuation: Simple wiring, for example, with small lateral distances in installation boxes.
- The conductor is pressed directly against the busbar via the hardened steel pressure clip
- The high contact force guarantees a gas-tight connection.

Field of application:

Housing designs or mounting conditions such as PCB inserts that do not allow right-angle screw actuation due to space constraints.

Crimp connection



The crimp connection technology was implemented in order to provide a cost-effective option for pre-assembly of connectors, even in very large quantities. The crimp contacts can

therefore be terminated not only with hand tools, but also in very high quantities on the automatic crimping machine in production. The contacts then only have to be snapped into the housings provided. This connection technology meets the high requirements in railroad technology.

Connection principle:

- Fast, fully automated pre-assembly of connectors possible
- Durable, form-fit connection technology
- Low contact resistance
- Conductor connection is extremely resistant to temperature fluctuations and vibration

Field of application:

Applications where fully automated and factory-oriented processing steps are to be combined with field wiring. Also in environmental conditions with temperature fluctuations and strong vibration.

Axial screw connection



This connection technology combines the advantages of screw and crimp connections. The stripped conductors are pushed axially into the contact. From the opposite side, a hexagon socket screw is turned axially into the conductor. The connection unit is space-saving and easy to handle. This technique is commonly used for larger cross-sections where space is limited at the same time. Conventional screw or tension clamp connections would be too large in these cases. The result is easy-to-assemble contacts with the same installation space as crimp contacts, but where, in contrast to crimp technology, the conductors can also be disconnected and reconnected without having to use a new contact.

Connection principle:









- Low space requirement of the contact
 - Easy handling: tool and conductor are kept in line during assembly
 - Three steps for a secure connection: strip conductor, insert stranded wire into contact chamber, screw on contact
-

Field of application:

Applications wherever multi-core conductors with large cross-sections are used and simple connection technology that can also be disconnected again is required.

The right connection for every application

An overview of the wire connection types for the fixed-pole connector inserts from Weidmüller

Products	Tension clamp connection	PUSH IN connection	SNAP IN connection	Axial screw connection	Screw connection	Screw connection with wire protection mechanism	TOP-1.5k connection	Crimp connection
								
HDC HA (3 to 4-pole)							✓	
HDC HA (10 to 48-pole)	✓					✓		✓
HDC HE	✓	✓	✓			✓		✓
HDC HEE								✓
HDC HEEE								✓
HDC HD								✓
HDC HDD								✓
HDC HVE	✓					✓		
HDC HSB						✓		
HDC HQ								✓
HDC S4				✓				
HDC S4/0				✓	✓			
HDC S4/2					✓			
HDC S6/12				✓			✓	
HDC S4/8					✓			
HDC S3/36								✓
HDC S8/24								✓
HDC S12/2								✓
HDC S6/6				✓			✓	
HDC S8/0				✓				
HDC HighPower 250 A								✓
HDC HighPower 550 A								✓

Crimp contacts

Whereas the contacts for screw, axial screw, tension clamp and PUSH IN connections are already built in, you can choose the appropriate contact for a crimp connection.



The heart of a connector is its contacts. They make up the actual connection between two conductors. Two types of contacts make this possible: pins and sockets (male and female). The pin conducts the electrical current on its outer surface and is introduced into the socket, which conducts the electrical current on its inner surface. Heavy-duty connectors have copper alloy contacts and the contact surfaces are plated with gold or silver: silver improves conductivity, gold is corrosion-proof.

Crimp contacts are available in turned, solid form.

Selection of silver or gold-plated contacts







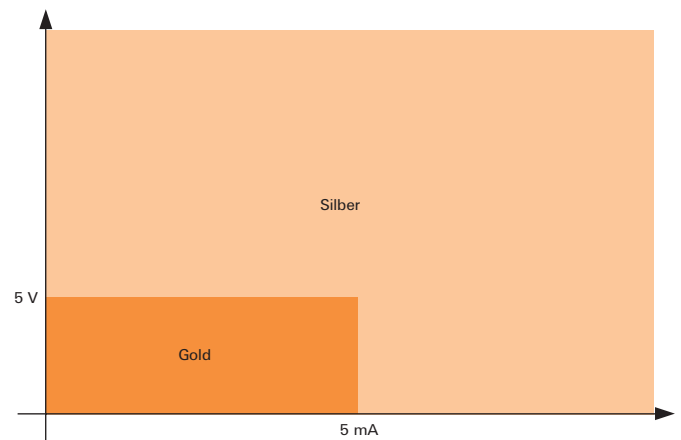



When using plug-in connectors under standard conditions, the resistance between the contacts has little effect. Even heavily corroded silver-coated contact pins and sockets do not exhibit any contact problems.

The situation is different where there are very small currents in extreme applications such as those in electroplating shops, tunnels or in cellulose processing. The silver oxide layer on the surface of the contacts forms an electrical resistance with capacitive, inductive and ohmic components. As a result, the original signal is distorted so much that the recipient is unable to detect it properly and interprets it incorrectly. This results in faults and indirectly, to damage to machines and processes. Gold-plated contacts should be used in such cases.

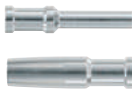
The rule of thumb is: use gold-coated contacts for currents < 5 mA and voltages of up to 5 V.



Overview of crimp contacts

	Article	Properties	Usage
	COAX contacts	Rated current: 1.5 A Surface finish: gold-plated	ModuPlug COAX Module
	MBUS contacts	Rated current: 0.5 - 4.0 A Cross-section: 0.50 - 1.00 mm ² AWG: 26 - 18 Surface finish: gold-plated	ModuPlug field-attachable data connector Cat.5 and Cat.6
	HD-, HDD contacts	Rated current: 10 A Cross-section: 0.14 - 2.50 mm ² AWG: 26 - 14 Surface finish: gold-plated silver-plated	HD Series HDD Series
	HE, HEE, thermal contacts Constantan and Iron	Rated current: 16 A Cross-section: 0.5 - 4.00 mm ² AWG: 20 - 12 Surface finish: gold-plated silver-plated Constantan	HA Series HE Series HEE Series HEEE Series HQ Series MixMate Series
	HX-contacts	Rated current: 40 A Cross-section: 1.5 - 6.00 mm ² AWG: 16 - 10 Surface finish: silver-plated	HQ Series MixMate Series
	CM-3 contacts	Rated current: 57 A Cross-section: 1.5 - 10.00 mm ² AWG: 16 - 7 Surface finish: silver-plated	HighPower signal contacts
	MHP 70	Rated current: 70 A Cross-section: 6 - 25 mm ² Surface finish: silver-plated	ModuPlug
	MHP 100	Rated current: 100 A Cross-section: 10 - 35 mm ² AWG: 8 - 2 Surface finish: silver-plated	ModuPlug
	MHP 200	Rated current: 200 A Cross-section: 25 - 70 mm ² Surface finish: silver-plated	ModuPlug
	HP contacts	Rated current: 250 A / 550 A Cross-section: 25 - 240 mm ² Surface finish: silver-plated	HighPower Series

Using wire-end ferrules

Type of connection	Series	HA	HE	HVE	HSB	
Screw	Clamping range [mm ²]	0.5 - 2.5	0.5 - 2.5	0.5 - 2.5	-	
	Clamping range [AWG]	20 - 12	20 - 14 (12) ¹⁾	20 - 14 (12) ¹⁾	-	
	Ferrules with collars	H0.5/14 - H2.5/14	H0.5/14 - H2.5/14 ²⁾	H0.5/14 - H2.5/14 ²⁾	H0.5/14 - H2.5/14 ²⁾	-
		H0.5/16 - H2.5/16	H0.5/16 - H2.5/16 ²⁾	H0.5/16 - H2.5/16 ²⁾	H0.5/16 - H2.5/16 ²⁾	-
	Ferrules without collars	H0.5/10 - H2.5/10	H0.5/10 - H2.5/10	H0.5/10 - H2.5/10	-	
	Twin wire-end ferrules with collars	H0.5/16.5 (ZH)	H0.5/18.5 (ZH)	-	H0.5/15 (ZH)	
		H0.5/18.5 (ZH)	H1.0/20 (ZH) ³⁾	-	H0.5/16.5 (ZH)	
		H0.75/17 (ZH)	H1.5/20 (ZH) ³⁾	-	H0.5/18.5 (ZH)	
		H1.0/20 (ZH)	-	-	H0.75/15 (ZH)	
		H1.5/20 (ZH)	-	-	H1.0/15 (ZH)	
Tension clamp	Crimping tool	PZ4 ²⁾ , PZ6, PZ6/5	PZ4 ²⁾ , PZ6, PZ6/5 PZ6 Hex ²⁾	PZ4 ²⁾ , PZ6, PZ6/5 PZ6 Hex ²⁾	-	
	Screwdriver	SDK PH0 SD 0.5x 3.0	SDK PH0 SD 0.5x 3.0	SDK PH0 SD 0.5x 3.0	-	
	Tightening torque	0.5 Nm	0.5 Nm	0.5 Nm	-	
	Clamping range [mm ²]	0.25 - 1.5	0.25 - 2.5	0.25 - 2.5	-	
		2.5 solid core	-	-	-	
	Clamping range [AWG]	24 - 14 ⁴⁾	24 - 14	24 - 14	-	
	Ferrules with collars	H0.5/14 - H1.5/14 ⁴⁾	H0.5/14 - H2.5/14 ²⁾	H0.5/14 - H2.5/14 ²⁾	-	
		H0.5/16 - H1.5/16 ⁴⁾	-	-	-	
	Ferrules without collars	H0.5/10 - H1.5/10 ⁴⁾	-	-	-	
	Twin wire-end ferrules with collars	-	H0.5/15 (ZH) ⁵⁾ or ⁶⁾	-	-	
-		H0.75/15 (ZH) ⁵⁾ or ⁶⁾	-	-		
-		H1.0/15 (ZH) ⁵⁾ or ⁶⁾	-	-		
-		H1.5/16 (ZH) ⁵⁾ or ⁶⁾	-	-		
Crimping tool	PZ4, PZ6, PZ6/5	PZ4 ⁷⁾ , PZ6, PZ6/5	PZ4 ⁷⁾ , PZ6, PZ6/5	-		
Screwdriver	SD 0.5x 3.0	SD 0.6x 3.5	SD 0.6x 3.5	-		
PUSH IN	Clamping range [mm ²]	-	solid 0.5 - 4 mm ² flexible with ferrule 0.5 - 2.5 mm ²	-	-	
		-	20 - 12	-	-	
	Ferrules with collars	-	H0.5/14 - H1.5/14	-	-	
		-	H0.5/16 - H1.5/16	-	-	
		-	H0.75/18 - H2.5/18 ²⁾	-	-	
	Ferrules without collars	-	H0.5/10 - H2.5/10 ²⁾	-	-	
		-	H1.5/12 - H2.5/12 ²⁾	-	-	
	Twin wire-end ferrules with collars	-	H0.5/18.4 ZH	500 V / 6 kV / 3	-	
		-	H1/20 ZH	400 V / 6 kV / 3	-	
		-	H1.5/20 ZH	400 V / 6 kV / 3	-	
-		-	500 V / 6 kV / 3 only with protection degree of at least IP54	-		
Ferrules crimped with	-	PZ4, PZ6, PZ6/5, PZ6 Hex	-	-		
PE contact	Clamping range [mm ²]	0.5 - 4.0	0.5 - 4	0.5 - 4	-	
		0.5 - 2.5 flexible	-	-	-	
	Clamping range [AWG]	20 - 12	20 - 12	20 - 12	-	
	Ferrules with collars	H0.5/16 - H2.5/16	H0.5/16 - H4/16	H0.5/16 - H4/16	-	
	Ferrules without collars	H0.5/10 - H2.5/10	H0.5/10 - H4/10	H0.5/10 - H4/10	-	
	Ferrules crimped with	PZ4 ²⁾ , PZ6, PZ6/5	PZ4, PZ6, PZ6/5, PZ6 Hex	PZ4, PZ6, PZ6/5, PZ6 Hex	-	
	Screwdriver	PH 1	PH 1	PH 1	-	
	Tightening torque	1.2 Nm	1.2 Nm	1.2 Nm	-	

¹⁾ Depending on the diameter of the insulation, the max. AWG wire may need to be pushed in with some force.

²⁾ The 2.5mm² wire must be inserted with some force.

³⁾ When the rated voltage is reduced to 400 V / 6 kV / 3 or with a protection degree of at least IP54.

⁴⁾ Only by tilting the screwdriver can the clamping point be opened all the way.

⁵⁾ Wire-end ferrules may be used when the rated voltage is reduced to 400 V / 6 kV / 3.

⁶⁾ When the protection degree is at least IP54, the creepage and clearance distances within the encapsulation may be rated for a lower pollution degree (DIN EN 61984). For this encapsulation, the use of wire-end ferrules is possible with 500 V / 6 kV / 3.

⁷⁾ The PZ4 crimping tool should not be used with the max. wire size.

The connector inserts can be combined with wire-end ferrules in other ways depending on the available clamping range and the type of cable being used. We would be happy to take a look at the technical feasibility of your specific application.

Tightening torques and screwing tools

Screw size	Connector type	Dia. tightening torque in Nm	Recommended blade inserts and AF size for hexagon socket
M2.5	Signal contacts		
	S 6/6	0.5 - 0.55	SD 0.6 x 3.5 mm or PZ0
	S 6/12	0.5 - 0.55	SD 0.6 x 3.5 mm or PZ0
M2.9 x 0.5	Fastening screws		
	HQ 4/2	0.8 (plastic) / 1.1 (metal)	SD 0.6 x 3.5 mm or PH0
	HQ 8	0.8 (plastic) / 1.1 (metal)	SD 0.6 x 3.5 mm or PH0
	HQ 17	0.8 (plastic) / 1.1 (metal)	SD 0.6 x 3.5 mm or PH0
M3	Contact screws		
	HA 3	0.5 - 0.55	SD 0.5 x 3.0 mm
	HA 4	0.5 - 0.55	SD 0.5 x 3.0 mm
	HA 10 to HA 48	0.5 - 0.55	SD 0.6 x 3.5 mm or PH0
	HE	0.5 - 0.55	SD 0.6 x 3.5 mm or PZ0
	HVE	0.5 - 0.55	SD 0.6 x 3.5 mm or PZ0
	Signal contacts:		
	S 4/2	0.5 - 0.55	SD 0.6 x 3.5 mm or PZ0
	S 4/8	0.5 - 0.55	SD 0.6 x 3.5 mm or PZ0
	PE connection via female contact		
	S 4	0.5 - 0.8	SD 0.6 x 3.5 mm
	ConCept modular frame, metal	0.5 - 0.55	SD 0.6 x 3.5 mm
	PE terminal		
	HQ 5	0.5 - 0.55	SD 0.6 x 3.5 or 0.8 x 4 mm
	HQ 7	0.5 - 0.55	SD 0.6 x 3.5 or 0.8 x 4 mm
	Fastening screws	0.5 - 0.55	SD 0.6 x 3.5 mm or PZ0
	Guide pin	0.5 - 0.55	SD 0.6 x 3.5 mm or PZ0
	Guide bush	0.5 - 0.55	SD 0.6 x 3.5 mm or PZ0
	Coding pins	0.5 - 0.55	SD 0.6 x 3.5 mm or PZ0
	M4	Contact screws	
HSB		1.2 - 1.5	SD 0.6 x 3.5 or 0.8 x 4 mm or PZ1
PE connection via male contact			
S 4		0.5 - 0.8	SD 0.6 x 3.5 mm
ConCept modular frame, metal		1.2 - 1.5	SD 0.6 x 3.5 mm
PE terminal			
HA		1.2 - 1.5	SD 0.6 x 3.5 or 0.8 x 4 mm or PH1
HE		1.2 - 1.5	SD 0.6 x 3.5 or 0.8 x 4 mm or PH1
HEE		1.2 - 1.5	SD 0.6 x 3.5 or 0.8 x 4 mm or PH1
HVE		1.2 - 1.5	SD 0.6 x 3.5 or 0.8 x 4 mm or PH1
HD		1.2 - 1.5	SD 0.6 x 3.5 or 0.8 x 4 mm or PZ1
HDD		1.2 - 1.5	SD 0.6 x 3.5 or 0.8 x 4 mm or PZ1
S 6/6 (for signal contacts)		1.2 - 1.5	0.8 x 4 mm or PZ1
ConCept modular frame, plastic		1.2 - 1.5	0.8 x 4 mm or PZ1
M5	PE terminal		
	HSB	2 - 2.5	SD 1 x 5.5 mm or PZ2
	S 4/0 (Screw connection)	2 - 2.5	SD 1.2 x 6.5 mm or PH2
	S 4/0 (Axial screw connection)	2 - 2.5	SD 0.8 x 4 mm or PZ2
	S 4/2	2 - 2.5	SD 1.2 x 6.5 mm or PH2
	S 4/8	2 - 2.5	SD 1.2 x 6.5 mm or PH2
	S 6/12	2 - 2.5	SD 0.8 x 4 mm or PZ2
	S 6/36	2 - 2.5	SD 1.2 x 6.5 mm or PH2
	S 8/24	2 - 2.5	SD 1.2 x 6.5 mm or PH2
	S 12/2	2 - 2.5	SD 1.2 x 6.5 mm or PH2
M6	Power contacts		
	S 4/0 (Screw connection)	1.2 (1.5 mm ²) / 2 (2.5 mm ²) / 3 (4 - 16 mm ²)	SD 0.8 x 4 mm
	S 4/2	1.2 (1.5 mm ²) / 2 (2.5 mm ²) / 3 (4 - 16 mm ²)	SD 0.8 x 4 mm
	S 4/8	1.2 (1.5 mm ²) / 2 (2.5 mm ²) / 3 (4 - 16 mm ²)	SD 0.8 x 4 mm
M7 x 0.75	Power contacts		
	S 4	1.1 - 1.7	SW 2
	S 6/6 (+ PE)	6 - 8	SW 4
M8 x 0.75	Power contacts		
	S 6/12	1.1 - 1.7	SW 2
	S 8/0 (+ PE)	6 (10 - 16 mm ²) / 7 (25 mm ²)	SW 4
M10 x 1	Power contacts		
	S 4/0 (Axial connection)	2 - 3	SW 3

Increasing the tightening torque does not improve the contact resistance. The stated torque settings offer optimal mechanical, thermal and electrical conditions. Exceeding the recommended values may even damage the conductor and terminal.

Torque housing

Series	Size	Version	Number of screws	Thread size	Recommended tightening torque
IP 65	Size 1	Attachment	2	M 3	0.8 ... 1.0 Nm
IP 65	Size 2	Attachment	4	M 3	0.8 ... 1.0 Nm
IP 65	Size 3	Attachment	4	M 4	0.8 ... 1.0 Nm
IP 65	Size 4	Attachment	4	M 4	0.8 ... 1.0 Nm
IP 65	Size 5	Attachment	4	M 3	0.8 ... 1.0 Nm
IP 65	Size 6	Attachment	4	M 4	0.8 ... 1.0 Nm
IP 65	Size 7	Attachment	4	M 4	0.8 ... 1.0 Nm
IP 65	Size 8	Attachment	4	M 4	0.8 ... 1.0 Nm
IP 65	Size 9	Attachment	4	M 5	2.5 Nm
IP 65	Size 10	Attachment	4	M 5	2.5 Nm
IP 65	Size 12	Attachment	4	M 5	2.5 Nm
EMV / IP65	Size 3	Attachment	4	M 4	1.0 Nm
EMV / IP65	Size 4	Attachment	4	M 4	1.0 Nm
EMV / IP65	Size 6	Attachment	4	M 4	1.0 Nm
EMV / IP65	Size 8	Attachment	4	M 4	1.0 Nm
IP 68	Size 1	Attachment	2	M 4	1.0 Nm
IP 68	Size 3	Attachment	4	M 6	3.0 Nm
IP 68	Size 6	Attachment	4	M 6	3.0 Nm
IP 68	Size 8	Attachment	4	M 6	3.0 Nm
IP 68	Size 1	Attachment/socket - plug	2	M 4	1.0 Nm
IP 68	Size 3	Attachment/socket - plug	2	M 6	3.0 Nm
IP 68	Size 6	Attachment/socket - plug	2	M 6	3.0 Nm
IP 68	Size 8	Attachment/socket - plug	2	M 6	3.0 Nm
IP66	Size 3	Flange-mounted housing	2	M 6	3 Nm
IP66	Size 4	Flange-mounted housing	2	M 6	3 Nm
IP66	Size 6	Flange-mounted housing	2	M 6	3 Nm
IP66	Size 8	Flange-mounted housing	2	M 6	3 Nm

RockStar® - Housing types

Housing IP65 / NEMA Type 4X



The housing and the interlock mechanism on a connector protect the contacts from exterior mechanical influences (ie. shock, contamination, dust, accidental touching, moisture penetration, water and liquids such as cleaning solvents, coolants and oils). The durable RockStar® housings are produced with the highest quality standards; they provide IP65 protection and are resistant to corrosion and impacts. All housings come standard with a stainless steel interlock. A special die-cast alloy and the multi-level surface finish combine to deliver the ultimate protection against extreme conditions and ensure that the housings keep their visual appeal.

Applications

- General mechanical engineering
 - Materials handling and factory construction
 - Packaging machines
 - Transport and traffic engineering
 - Energy technology
 - Lighting and stage equipment
 - Process engineering
- etc.

Features

- Tightness at least IP65 to IEC 60529
- Tightness NEMA Type 12, 4X
- Scratch-resistant, corrosion-proof, long-lasting

Design

- Cast aluminium alloy
- Multistage surface coating
- Colour: grey, similar to RAL 9006
- 3 versions, standard, high and XXL
- 11 sizes

Interlock system

- Clamp lock in different versions
- rustproof stainless steel

HQ Series Housings, IP65 / NEMA Type 4X



The HQ connector series has a very compact housing with IP65 protection. It is available in either plastic or metal. The full industrial capability of these products makes them a perfect match for the main usage in materials handling applications. The HQ housing series is particularly important for connecting motor starters and frequency converters. It is also the ideal extension for setting up a decentralised power distribution system based on FieldPower®.

Applications

- General machine construction
 - Materials handling and factory construction
 - Decentralised automation
- etc.

Features

- Tightness: at least IP65, acc. to IEC 60529
- Tightness: NEMA Type 12, 4X
- Complies with VDE and ISO 23570 (DESINA)
- Scratch-proof, corrosion resistant and durable

Design

- Plastic housing: polycarbonate, glass-fibre reinforced; Colour: grey, similar to RAL 7032
- Metal housing: die-cast zinc, nickel-plated, multi-level surface coating, EMC properties
- Cable outlet is straight or angled

Interlock system

- Clamp interlock made from rust-free stainless steel

IP65 EMC housing



In today's industrial environment, machines, plant and devices are becoming more and more complex. At the same time, automation is also on the rise. Lots of sensors and actuators are controlled to transmit or receive sensitive signals. And what's more, reliability and availability are becoming increasingly important quality features of machines and devices. This means that they need to be optimally designed in terms of electromagnetic compatibility (EMC).

Applications

- Machine construction
- Wind energy
- Transportation

Features

- Labyrinth structure on the housing
- FPM seal material
- Conductive surface
- O-ring seal
- IP65 protection class acc. to 60529
- Scratch-proof, corrosion resistant and durable

Design

- Die-cast aluminium, resistant to sea water
- Multi-level surface coating
- Colour: black, similar to RAL 9005
- Four sizes
- Cable outlet is straight or lateral

Interlock system

- Removable clamp lock in different versions
- Clamp system made of polyamide with internal stainless steel spring

Housing IP68



The IP68 housings have been developed for use under extreme environmental conditions. The high degree of protection (IP68 and IP69K) and the excellent resistance to vibration and shock guarantee fail-safe operation when heavy-duty connectors are used in vehicles and under tough climatic conditions. If you want to protect your delicate interfaces from EMC emissions, these connectors are the right choice for you.

Applications

- Transport and traffic engineering
- Energy technology
- Applications with extreme protection class requirements

Features

- Labyrinth structure on the housing
- Silicone sealing material
- Conductive surface
- O-ring seal
- Tightness IP68 / 5 bar to IEC 60529
- IP69K impermeability according to DIN 40050-9
- Scratch-proof, corrosion resistant, impact resistant and durable

Design

- Cast aluminium alloy
- Multistage surface coating
- Optimised construction for high impact resistance and EMC
- Colour: black RAL 9005
- 5 sizes; size 8 also in XXL

Interlock system

- Screw cap with internal/external hex drive

RockStar® - Housing types

Flange-mounted housing IP66



Our flange-mounted housings made of plastic have a built-in cable gland and a screw interlock. They seal directly onto the panel wall and can therefore be used without an attachment housing. The housings are impressive with their low weight and optimal protection against contamination, water and vibrations.

Applications:

- Machinery and plant engineering
- Automotive industry
- Panel building
- Wind power plants

Features:

- Impermeability IP66/67 acc. to IEC 60529
- Impermeability NEMA type 12, 4X
- Resistance against impacts acc. to DIN EN 50102
- Robust, durable, corrosion resistant

Design

- Plastic housing made of polyamide
- Colour: black
- Four sizes
- Cable outlet is straight or angled

Interlock system

- Screw connection with hexagon socket
- Material: stainless steel

Locking systems

One longitudinal locking clamp on housing bottom



- Manual operation – no tools required
- 2 locking points – along the longitudinal axis
- Good for lengthwise alignment
- Interlock system made from rust-free stainless steel

One central locking clamp on housing top



- Manual operation – no tools required
- 2 locking points along the transverse axis
- Easily accessible from above where space is limited
- Made from rust-free stainless steel

Two transverse locking clamps on housing bottom



- Manual operation – no tools required
- 4 locking points – good sealing effect
- Easily accessible when the cable inlet is in the plugging direction
- Good for aligning side by side
- Made of plastic and rust-free stainless steel

Screw fastening



- Uses internal/external hex drive
- Most effective seal
- The two interlock points are arranged diagonally
- Easily accessible when space is tight
- Screws made from rust-free stainless steel

Two transverse locking clamps on housing top

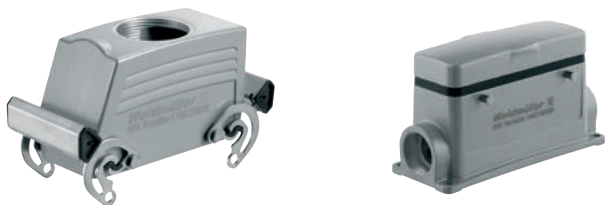

- Manual operation – no tools required
- 4 locking points – good sealing effect
- Easily accessible when the cable inlet is in the plugging direction
- Good for aligning side by side
- Interlock system made from rust-free stainless steel

Part codes for housings IP65

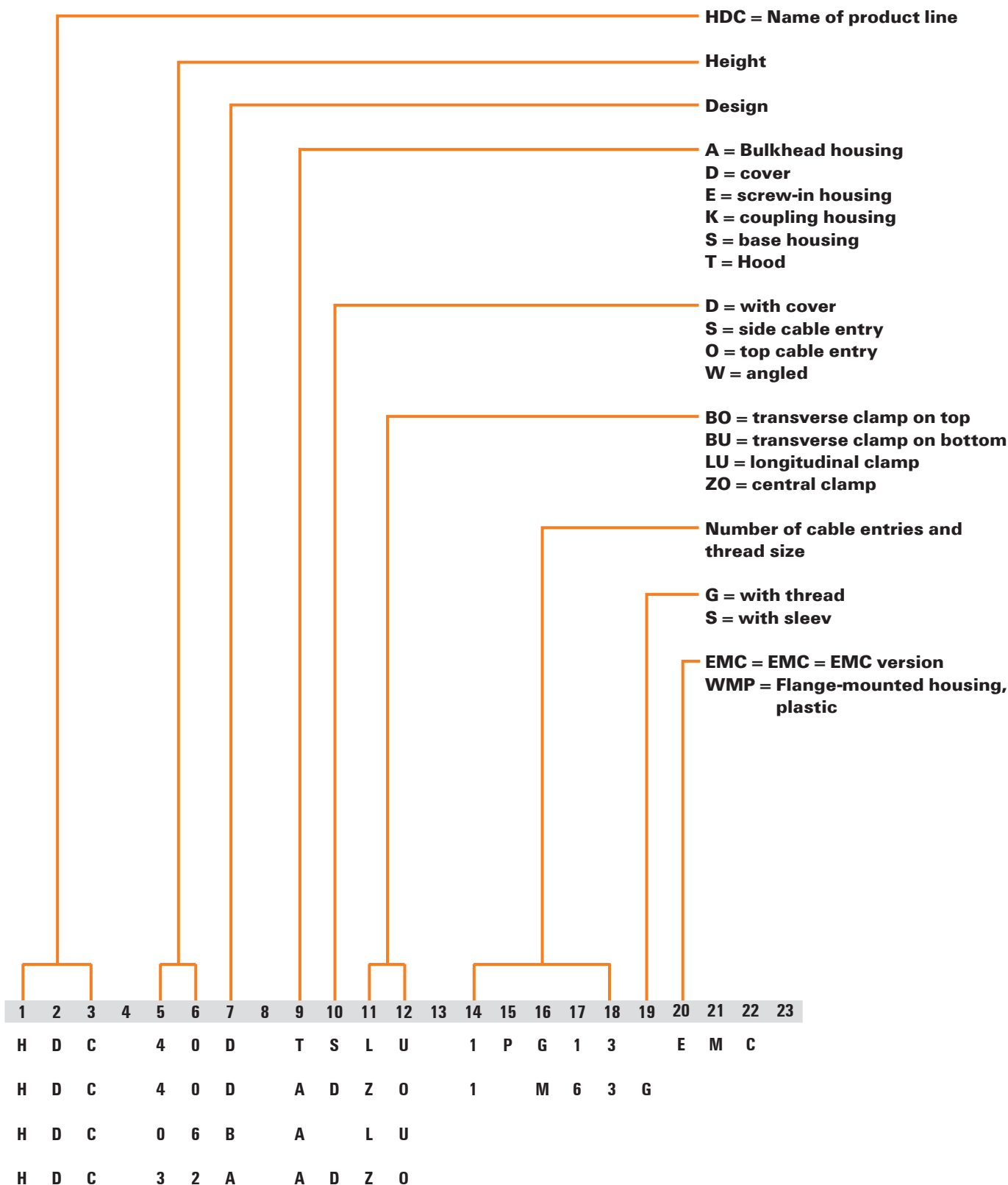

Part codes for covers

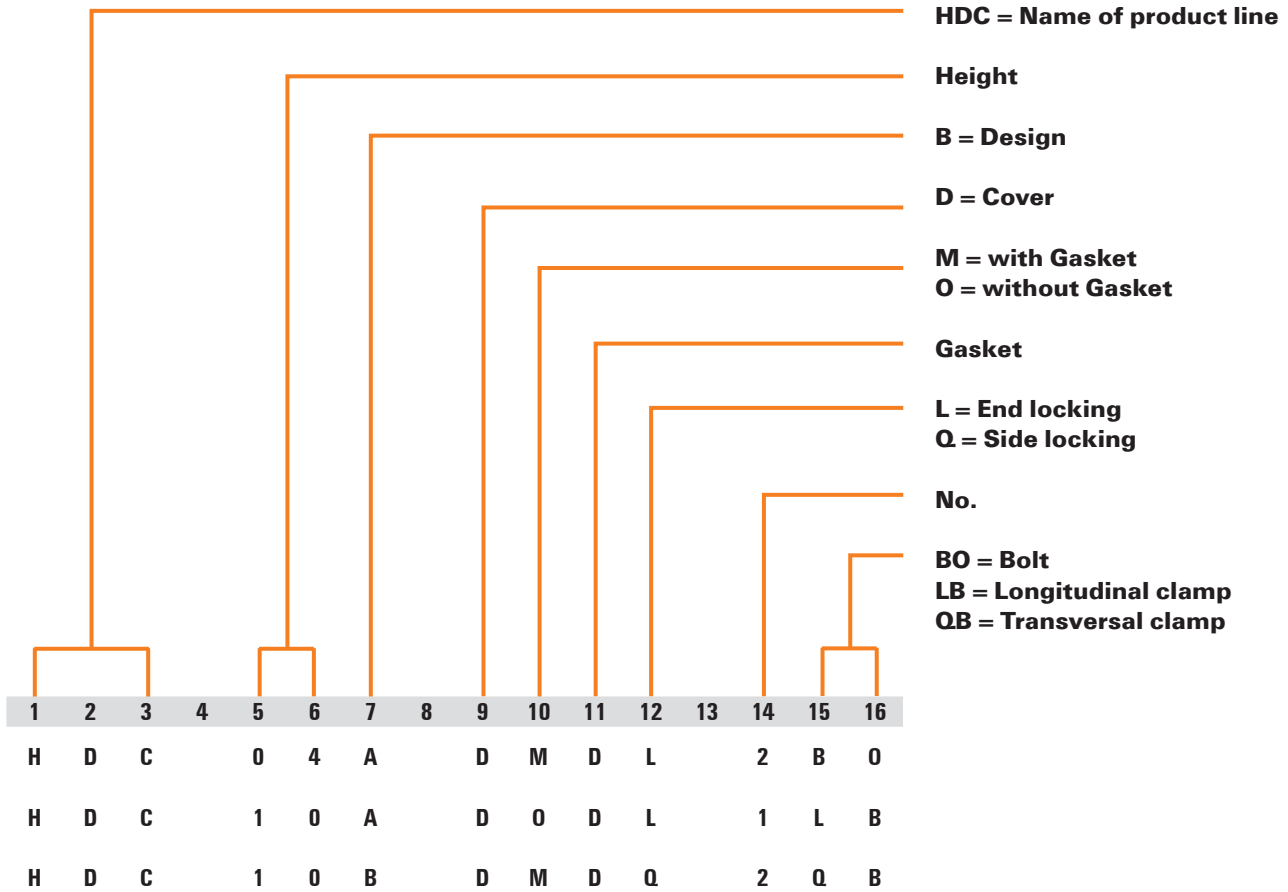

Part codes for housings IP68

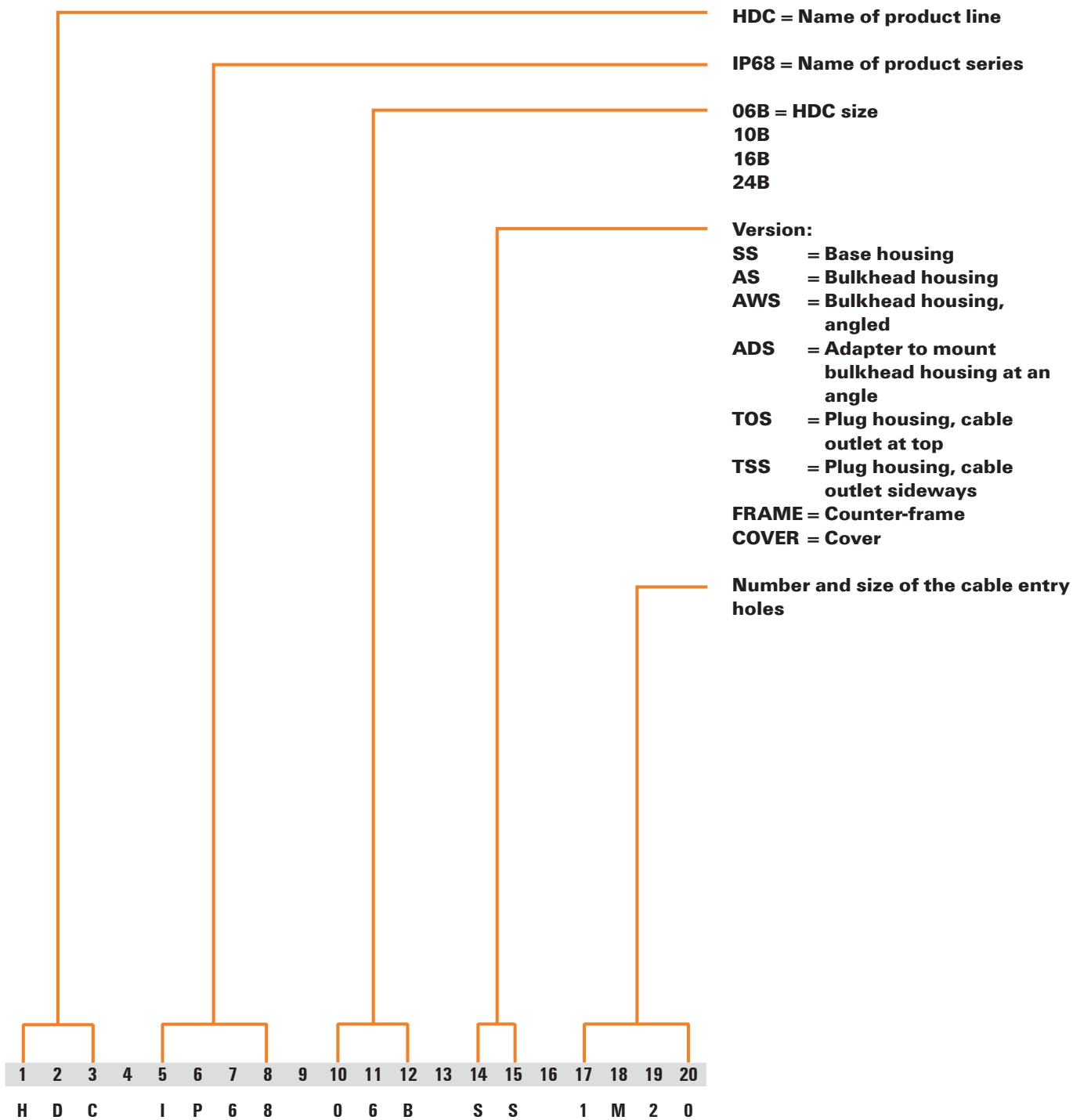

Panel cut-out Housings IP65

Size	Designation	
BG1	04A/07A	
BG2	10A	
BG3	06B	
BG4	10B	
BG5	16A	
BG6	16B	

Size	Designation					
BG7	32A					
BG8	24B					
BG9	48A					
BG10	32B					
BG12	48B					
HQ		<table border="0"> <tr> <td style="text-align: center;">AWLU/SLU</td> <td style="text-align: center;">ALU</td> </tr> <tr> <td></td> <td></td> </tr> </table>	AWLU/SLU	ALU		
AWLU/SLU	ALU					

Panel cut-out Housings IP68

XXL Housings in IP68

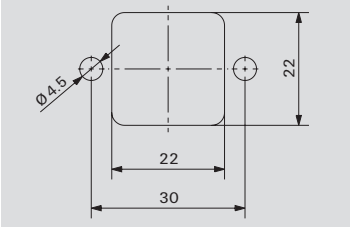
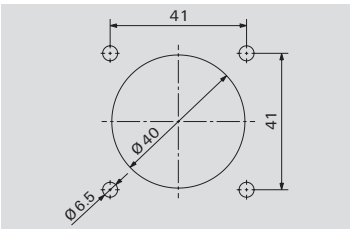
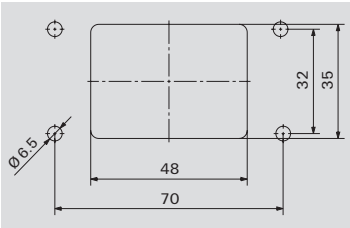
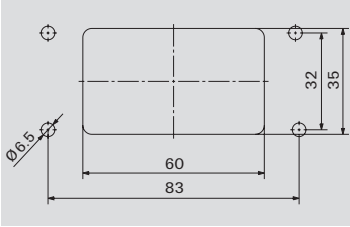
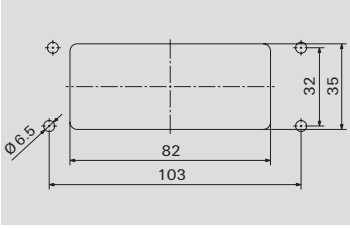
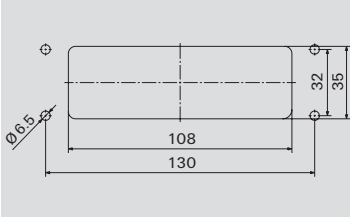
Size	Designation	
BG1	04A	
BG1	04A AWS	
BG3	06B	
BG4	10B	
BG6	16B	
BG8 BG8	24B HP 24B	

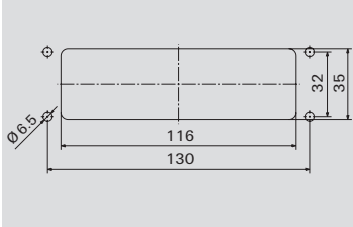
Size	Designation	
BG8	HB24	

Electrical data

A

Design of clearances and creepage distances in electrical equipment

General

Since April 2003, the rules of DIN EN 60664-1 / 11.03 in conjunction with DIN 61984 / 09.02 apply to the dimensioning of clearances and creepage distances.

The design data resulting from these provisions is – if applicable – specified in this catalogue for each product.

For the design of clearances and creepage distances, application of the regulations for insulation coordination produces the following interrelationships:

Clearances

Clearances are rated in accordance with the following factors:

- Anticipated surge:
rated impulse withstand voltage
- Used
surge protection precaution
- Measures to prevent pollution:
pollution severity

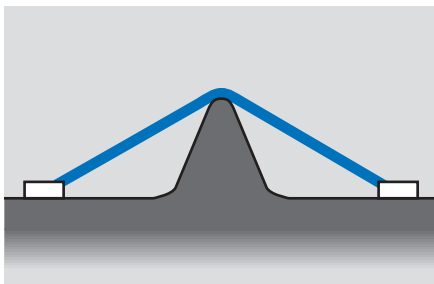

Creepage distances

Creepage distances are rated in accordance with the following factors:

- Planned
rated voltage
- Insulation materials used:
insulation group
- Measures to prevent pollution:
pollution severity

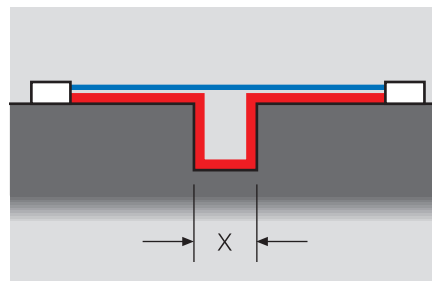
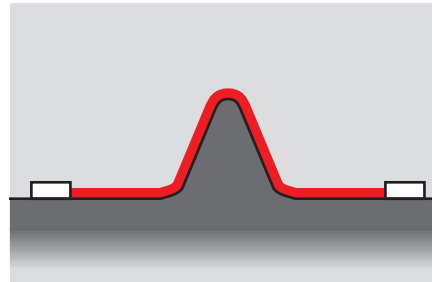

Slots are taken into account when measuring creepage distances if their minimum width x is dimensioned according to the following table:

Pollution severity	Minimum width x in mm
1	0.25
2	1.0
3	1.5
4	2.5

If the associated clearance in air is less than 3 mm, the minimum slot width can be reduced to $\frac{1}{3}$ of the clearance.

Influencing factors:**Rated impulse withstand voltage**

The rated impulse withstand voltage is derived from:

- **Phase-to-earth voltage** (the nominal voltage of the network, taking all networks into account)
- **Surge category**

The surge categories are defined in accordance with international standard DIN EN 60664-1 (for electrical equipment fed directly from the low voltage network):

Surge category I

Equipment that is intended to be connected to the permanent electrical installation of a building. Measures to limit transient surges to the specific level are taken outside the equipment, either in the permanent installation or between the permanent installation and the equipment.

Surge category II

Equipment to be connected to the permanent electrical installation of a building e.g. household appliances, portable tools and similar loads.

Surge category III

Equipment that is part of the permanent electrical installation and other equipment where a higher degree of availability is expected e.g. distribution boards, circuit-breakers, wiring systems (IEV 826-06-01, including cables, busbars, junction boxes, switches, power sockets) in the permanent installation, and equipment for industrial use and some other equipment, e.g. stationary motors with permanent connections to the permanent installation.

Surge category IV

Equipment for use at or in the proximity of the incoming supply point of the electrical installations of buildings upstream of the main distribution board e.g. electricity meters, circuit-breakers and ripple control units.

Pollution severity categories:**Pollution severity category 1**

No pollution, or only dry, non-conductive pollution that has no influence.

Pollution severity category 2

Non-conductive pollution only; occasional condensation may cause temporary conductivity.

Pollution severity category 3

Conductive pollution, or dry, non-conductive pollution that is liable to be rendered conductive through condensation.

Pollution severity category 4

Contamination results in constant conductivity, e.g. caused by conductive dust, rain or snow.

The dimensioning of clearances and creepage distances, and hence the rating data for electromechanical products (terminals, terminal strips, PCB terminals and plug-in connectors) is based on pollution severity 3 and surge category III, taking account of all network types.

Table 1: Three-phase 4 or 3-conductor a.c. systems

Nominal voltage of power supply systems V	For conductor-cond. insulat.	For conductor-earth isolation	
	all Systems V	3-phase 4-conductor systems with earthed neutral cond. V	3-phase 4-conductor systems unearthed or cond. earthed V
60	63	32	63
110			
120	125	80	125
127			
150	160	-	160
208	200	125	200
220			
230	250	160	250
240			
300	320	-	320
380			
400	400	250	400
415			
440	500	250	500
480			
500	500	320	500
575	630	400	630
600	630	-	630
660			
690	630	400	630
720			
830	800	500	800
960	1,000	630	1,000
1,000	1,000	-	1,000

Electrical data

Design of clearances and creepage distances in electrical equipment, influencing factors:

Rated voltage

The rated voltage is derived from the nominal voltage of the power supply and the corresponding network type.

Single-phase

2- or 3-wire AC or DC systems

Rated voltage of the power supply (mains) ¹⁾	Voltages for table 4	
	For insulation phase-to-phase ¹⁾	For insulation phase-to-earth ¹⁾
	All systems	3-wire systems neutr. point earthing
V	V	V
12.5	12.5	-
24/25	25	-
30	32	-
42/48/50 ^{**)}	50	-
60	63	-
30 - 60	63	32
100 ^{**)}	100	-
110/120	125	-
150 ^{**)}	160	-
220	250	-
110 - 220	250	125
120 - 240		
300 ^{**)}	320	-
220 - 440	500	250
600 ^{**)}	630	-
480 - 960	1,000	500
1,000 ^{**)}	1,000	-

3-phase

3- or 4-wire AC systems

Rated voltage of the power supply (mains) ¹⁾	Voltages for table 4		
	For insulation phase-to-phase	For insulation phase-to-earth	
	All systems	3-phase 4-wire systems with earthed neutral wire ²⁾	3-phase 3-wire systems unearthed ¹⁾ or phase-earthed
V	V	V	V
60	63	32	63
110/120/127	125	80	125
150 ^{**)}	160	-	160
208	200	125	200
220/230/240	250	160	250
300 ^{**)}	320	-	320
380/400/415	400	250	400
440	500	250	500
480/500	500	320	500
575	630	400	630
600 ^{**)}	630	-	630
660/690	630	400	630
720/830	800	500	800
960	1,000	630	1,000
1,000 ^{**)}	1,000	-	1,000

1) Phase-to-earth insulation levels for unearthed or impedance-earthed systems are equal to those of phase-to-phase because the operating voltage to earth of any phase can, in practice, reach full phase-to-phase voltage. This is because the actual voltage to earth is determined by the insulation resistance and capacitive reactance of each phase to earth; thus, a low (but acceptable) insulation resistance of one phase can earth it and raise the other two to full phase-to-phase voltage to earth.
 2) For electrical equipment for use in both 3-phase 4-wire and 3-phase 3-wire supplies, earthed and unearthed, use the values for 3-wire systems only.
^{*}) It is assumed that the rated voltage of the electrical equipment is not lower than the nominal voltage of the power supply.
^{**)} Because of the common changes, the meaning of the ** symbol has not been used in table 1; i.e. the / symbol indicates a 4-wire 3-phase distribution system. The lower value is the phase-to-neutral voltage, while the higher value is the phase-to-phase voltage. Where only one value is indicated, it refers to 3-wire 3-phase systems and specifies the value phase-to-phase. The values given in table 1 are still taken into account in tables 3a and 3b by the ** symbol.

Insulating material

The insulating materials are subdivided into four groups according to their CTI (Comparative Tracking Index):

Insulating material	
I	600 ≤ CTI
II	400 ≤ CTI < 600
III a	175 ≤ CTI < 400
III b	100 ≤ CTI < 175

The comparative tracking index must be determined according to DIN IEC 112/VDE 0303 part 1 on the basis of specially prepared samples with test solution A.

The **derating curve** shows which currents may flow continuously and simultaneously via all possible connections when the component is subjected to various ambient temperatures below its upper limit temperature.

The **upper limit temperature** of a component is the rated value determined by the materials used. The total of the ambient temperature plus the temperature rise caused by the current load (power loss at contact resistance) may not exceed the upper limit temperature of the component, otherwise it will be damaged or even completely ruined. The current-carrying capacity is hence not a constant value, but rather decreases as the component ambient temperature increases. Furthermore, the current-carrying capacity is influenced by the geometry of the component, the number of poles and the conductor(s) connected to it.

The current-carrying capacity is determined empirically according to DIN IEC 60512-3. To do this, the resulting component temperatures t_{b1} , t_{b2} ... and the ambient temperatures t_{u1} , t_{u2} are measured for three different currents I_1 , I_2 , I_3 The values are entered on a graph with a system of linear coordinates to illustrate the relationships between the currents, the ambient temperatures and the temperature rise in the component.

Base curve

upper limit temperature of component

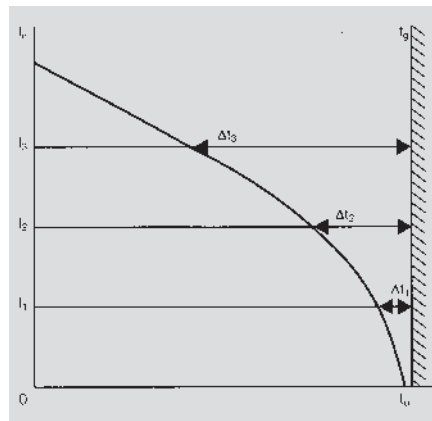

t_g = upper limit temperature of component
 t_u = ambient temperature
 I_n = current

The loading currents are plotted on the y-axis, **the component ambient temperatures** on the x-axis. A line drawn perpendicular to the x-axis at the upper limit temperature t_g of the component completes the system of coordinates. The associated average values of the temperature rise in the component, $\Delta t_1 = t_{b1} - t_{u1}$, $\Delta t_2 = t_{b2} - t_{u2}$, ... are plotted for every current I_1 , I_2 , ... to the left of the perpendicular line. The points generated in this way are joined to form a roughly parabolic curve.

As it is practically impossible to choose components with the maximum permissible contact resistances for the measurements, the base curve must be reduced. Reducing the currents to 80 percent results in the **“derating curve”** in which the maximum

Derating curve

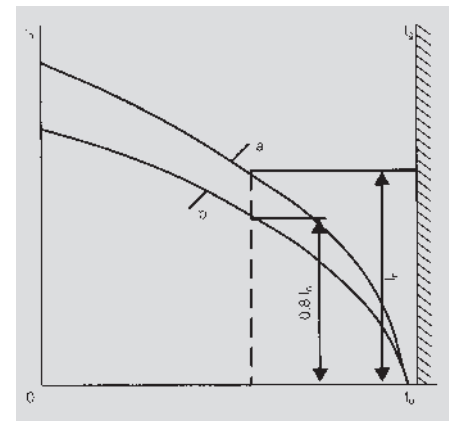

t_g = upper limit temperature of component
 t_u = ambient temperature
 I_n = current
 a = Base curve
 b = Reduced base curve (derating curve)

permissible contact resistances and the measuring uncertainties in the temperature measurements are taken into account in such a way that they are suitable for practical applications, as experience has shown. If the derating curve exceeds the currents in the low ambient temperature zone, which is given by the current-carrying capacity of the conductor cross-sections to be connected, then the derating curve should be limited to the smaller current in this zone.

Electromagnetic compatibility (EMC)

Many interfaces require the use of a connector that is EMC-compliant.

What is meant by the phrase EMC-compliant?

Electro-magnetic compatibility (EMC) refers to the ability of electrical equipment to function satisfactorily in its electromagnetic environment without introducing intolerable electromagnetic disturbances to anything in that environment.

(DIN VDE 0870). An electrical component or electrical equipment is considered to be compatible when their emissions and sensitivity levels are within a tolerable range (i.e., when there is sufficient interference immunity).

The basics

There are several types of measurements that can be used to determine the effectiveness of a cable shield. The method used here is the KS 04 B measurement from VG 95 373-41 "Electromagnetic compatibility of devices – methods for measuring shielded cable and shielded protective cable hoses". This method enables the quality of the shield to be evaluated. It also assesses the influence of the contact points of the shielding braid as well as the male and female plug components.

A standardised test cable with a length of one metre is used. This, and the fact that this measurement is carried out in a 50-ohm system which does not take the actual line impedance into account, leads to characteristic resonance effects. This means that this measurement process only delivers meaningful results up to a frequency of 30 to 100 MHz. It is, however, well suited for evaluating and comparing the effectiveness of various shielding and shield-contacting methods. It does not deliver an absolute value that would enable the limiting of voltages coupled in a cable, using an imposed HF electromagnetic field. The user should always consider the measurement results relative to the laboratory operational situation. Your actual, real-world shield attenuation values will normally be less than the values achieved in the lab because of different cable lengths, impedance behaviour and non-optimal earthing.

Testing methods

The method applied does not use the normative tri-axial measuring platform, but instead uses an aluminium plate (with dimensions 500 x 380 x 10 mm). This plate serves as the test's reference earth. HF sockets (N-standard) are mounted on two standing angular panels and are used to connect the measuring device. The flange along with the plug are mounted to one of the angular panels.

The limit value of the shield attenuation S_a is
 $f < 1 \text{ MHz}$: 60 dB

$1 \text{ MHz} < f < 100 \text{ MHz}$: 60 – 30 dB with 15 dB per decreasing decade
 $f = 100 \text{ MHz}$: 30 dB

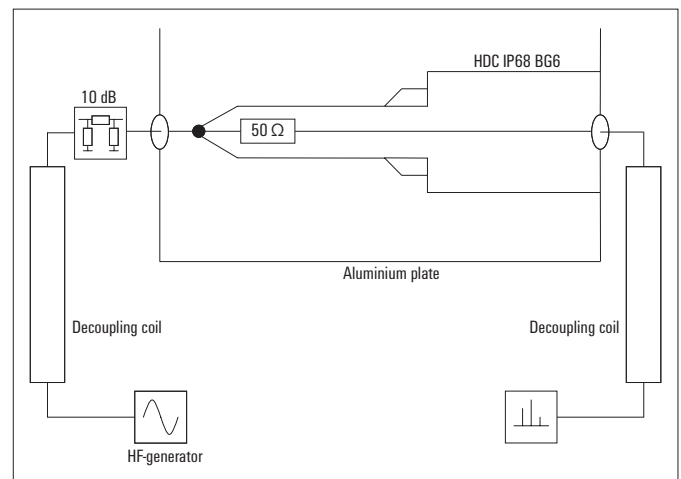

According to VG 95373-41, a frequency range up to 30 MHz is specified for the measurement process. However the range can be extended to about 100 MHz for information purposes.

The insertion loss as of the test object is determined by the relationship between the voltage on the interior wire and the supplied voltage. The VG95373-41 also refers to the insertion loss as the shield attenuation factor. The relationship between insertion loss as and coupling resistance Z_k is characterised as follows:

Insertion loss: $a_s \approx 20 \lg 50 \Omega / |Z_k|$ in dB

Coupling resistance: $Z_k \approx 50 \Omega \times 10^{a_s / 20}$ in Ω

According to VG 95373-41, this relationship has sufficient precision when $Z_k < 500 \text{ m}\Omega$.

In order to test plug-in connectors, a reference shield cable is used that is separated in the middle. The cable can be connected with a corresponding connector pair and measured as described above. In order to evaluate the shield (the resistance between the cable shield and the reference earth), the connector frame and its reference earth are mounted directly to the cover of the testing equipment.

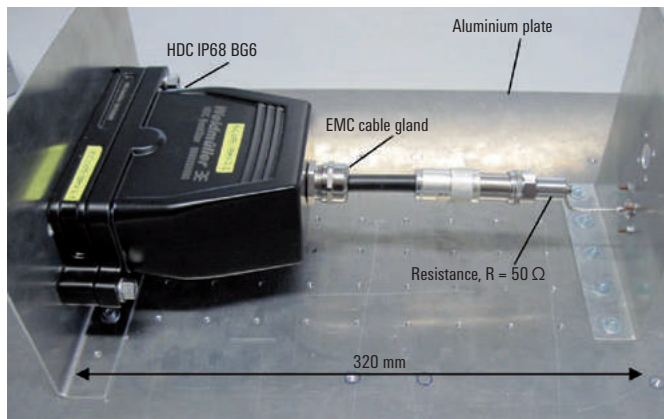

Housing must have very good EMC characteristics in order to meet these requirements.

Weidmüller has designed the RockStar® IP68 housing with built-in features that ensure outstanding EMC and resistance to interference.

The bulkhead or base housing, combined with the plug housing, produces a labyrinth structure which ensures high EMC shield attenuation. In addition to providing the required EMC protection, this housing series features IP68/IP69K protection and excellent resistance to impacts and vibration. This combination of features permits the RockStar® IP68 housing to be used anywhere.

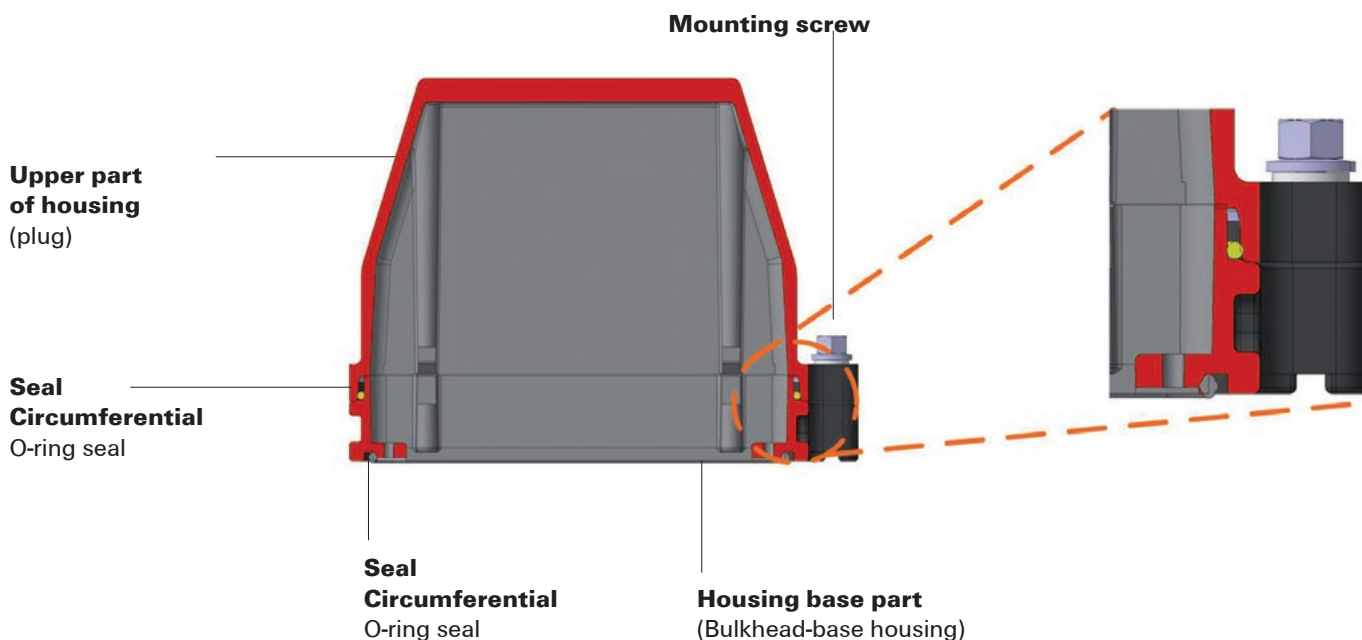

The requirements for an EMC-compliant interface stipulate that the interference immunity level or shield attenuation potential should be rated high enough so that the electromagnetic fields in the vicinity of the transmitted signals cannot exert influence within the connector. The capacity for active interference must be low enough to ensure that surrounding devices or components are not affected by interference. The following diagrams illustrate the insertion loss and the coupling impedance for the adjacent housing.

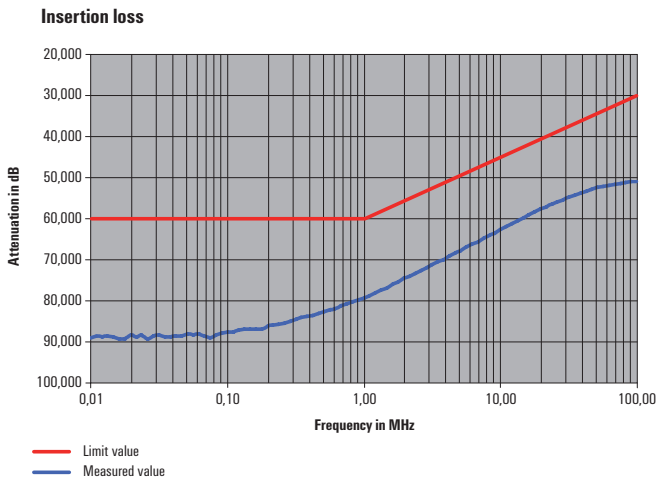

HDC IP68 16B TSS 1M50

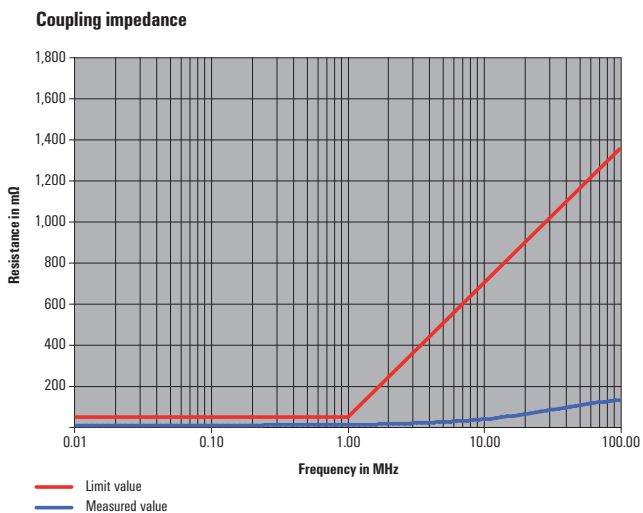

IP classes of protection to IEC 60529

The class of protection is indicated by a code consisting of the two letters IP and two digits representing the class of protection.

Example: **I P 6 5**

2nd digit: protection from liquids
1st digit: protection from solid bodies

Protection against intrusion of external particle matter (1st digit)

Digit		
0		No protection
1		Protection against ingress of large solid bodies with diameter > 50 mm. (Protection to prevent dangerous parts being touched with the back of the hand.)
2		Protection against ingress of large solid bodies with diameter > 12.5 mm. (Protection to prevent dangerous parts being touched with the fingers.)
3		Protection against ingress of large solid bodies with diameter > 2.5 mm. (Protection to prevent dangerous parts being touched with a tool.)
4		Protection against ingress of large solid bodies with diameter > 1 mm. (Protection to prevent dangerous parts being touched with a piece of wire.)
5		Protection against harmful deposits of dust, which cannot enter in an amount sufficient to interfere with satisfactory operation.
6		Complete protection against ingress of dust.

Protection against penetration of liquids (2nd digit)

Digit		
0		No protection
1		Protection against drops of condensed water falling vertically.
2		Protection against drops of liquid falling at an angle of 15° with respect to the vertical.
3		Protection against drops of liquid falling at an angle of 60° with respect to the vertical.
4		Protection against liquids splashed from any direction.
5		Protection against water jets projected by a nozzle from any direction.
6		Protection against water from heavy sea on ships' decks.
7		Protection against immersion in water under defined conditions of pressure and time.
8		Protection against indefinite immersion in water under defined conditions of pressure (which must be agreed between manufacturer and user and must be more adverse than number 7).

Class of protection to NEMA

National Electrical Manufacturers Association NEMA 250-1991

Digit		Digit	
Typ 1	Housing primarily for use in inside rooms. Protects from penetration of solid bodies.	Typ 12	Housing for use in inside rooms. Protects from dust deposits and non-corrosive dripping liquids.
Typ 2	Housing primarily for use in inside rooms. Protects from penetration of solid bodies and water.	Typ 13	Housing for use in inside rooms. Protects from dust deposits, water spray, oil and non-corrosive coolants.
Typ 3	Housing primarily for outdoor use. Protection against penetration by rainfall and dust as well as damage due to ice formation.		
Typ 3R	Housing primarily for outdoor use. Protection against rain and snow as damage due to ice-formation.		
Typ 3S	Housing primarily for outdoor use. Protection against rain, snow and foreign bodies. External mechanisms can be operated despite ice accumulation.		
Typ 4	Housing for inside and outside rooms. Protects from rain, foreign bodies, water spray and water jets as well as damage through ice formation on the outside of the housing.		
Typ 4X	Housing for inside and outside rooms. Protects from corrosion, rain, foreign bodies, water spray and water jets as well as damage through ice formation on the outside of the housing.		
Typ 6	Housing for inside and outside rooms. Protects from water jets as well as penetration of water when submerged; protects from damage through ice formation on the outside of the housing.		

Chemical resistance

Chemical resistance of inserts (material PC, 20 % GF)

Acetone	+
Ammonia, aqueous	-
Petrol	+
Benzine	+
Diesel oil	-
Acetic acid, concentrated	+
Aqueous potassium hydroxide	-
Methanol	-
Engine oil	-
Alkaline solution, diluted	+
Chlorinated hydrocarbons	-
Use in open air	-

+ resistant
- partially resistant

Chemical resistance of standard housing seal (material NBR)

Acetone	-
Drilling oil	+
Diesel oil	+
Ethyl alcohol	+
Gear oil	+
Hydraulic oil	+
Cooling lubricant	+
Petrol	+
Sweat	+
High-octane petrol	-
Water	+
UV	o
Ozone	o

+ resistant
- partially resistant
o not resistant

Chemical resistance of inserts (material PA6.6, 20 % GF)

Acetone	+
Ammonia, aqueous	+
Benzine	+
Diesel oil	+
Acetic acid, concentrated	-
Aqueous potassium hydroxide	+
Methanol	+
Engine oil	+
Alkaline solution, diluted	-
Chlorinated hydrocarbons	-
Use in open air	-

+ resistant
- partially resistant

Chemical resistance of silicone seal housing IP68

Acetone	+
Diesel oil	o
Ethyl alcohol	+
Gear oil	-
Hydraulic oil	-
Petrol	o
Sweat	-
High-octane petrol	o
Water	+
UV	+
Ozone	+

+ resistant
- partially resistant
o not resistant

Chemical resistance of FKM seal

Acetone	o
Diesel oil	+
Ethyl alcohol	+
Hydraulic oil	+
Acids	o
Benzine	+
Water	+
UV	+
Ozone	+

+ resistant
o not resistant

Safety information and standards

Please note the following safety information:

- Never plug or unplug connectors under load or during operations.
- We can only guarantee the technical and electro-technical characteristics promised in this catalogue if all the components were supplied by Weidmüller.

The following standards apply in the vicinity of heavy-duty connectors:

- DIN EN 60664-1 or IEC 60664-1: Insulation coordination for equipment within low-voltage systems; principles, requirements and tests (replaces DIN VDE 0110-1)
- DIN EN 61984 or IEC 61984:
Plug-in connectors – safety requirements and tests
- DIN EN 175301-801:
Detail Specification: High-density rectangular plug-in connectors, round removable crimp contacts; (replaces DIN 43652)
- DIN EN 60352 or IEC 60352:
Solderless connections
- DIN EN 60529 or IEC 60529:
Classes of protection provided by enclosures (IP code)
- DIN VDE 0870:
Electromagnetic influence
- DIN EN 60999-1:
Connecting devices, safety requirements for screw terminal connections and screwless terminal connections for electrical copper conductors
- DIN 40050-9:
Road vehicles; classes of protection (IP-code)

RockStar® inserts

RockStar® inserts	Introduction	B.2
	HA series	B.4
	250 V	
	16 A	
	3 - 48 poles	
	HE series	B.18
	500 V	
	24 A	
	6 - 48 poles	
	HEE series	B.32
	500 V	
	16 A	
	10 - 64 poles	
	HEEE series	B.44
	500 V	
	16 A	
	40 - 64 poles	
	HD series	B.50
	250 V	
	10 A	
	7 - 128 poles	
	HDD series	B.70
	250 V	
	10 A	
	24 - 216 poles	
	HVE series	B.84
	830 V	
	20 A	
	3 + 2; 6 + 2; 10 + 2 poles	
	HSB series	B.92
	400 V	
	35 A	
	6 - 12 poles	
	HQ series	B.98
	400 V / 690 V	
	16 A, 10/40 A	
	4/2, 5, 7, 8, 12, 17 poles	
	MixMate series	B.112
	1,000 V / 690 V	
	100 A	
	4, 4/0, 4/2, 4/8, 6/6, 6/12, 6/36, 8/0, 8/24, 12/2 poles	

Fixed pole RockStar® inserts

Flexible. Compact. High performance.

Rely on real RockStars when choosing your connectors. Our broad portfolio of heavy-duty connectors offers the right solution for all requirements for the transmission of energy, signals, and data outside the control cabinet. At the heart of our RockStar® connectors are the inserts. No matter which interface you want to implement, the nine series in up to 12 sizes ensure reliable electrical function.

The RockStar® inserts are made from glass-fibre-reinforced polycarbonate. This material is distinguished by its low water absorption and the high levels of dimensional stability made possible by the added glass fibres. So our rugged RockStar® inserts are the ideal choice for solutions of up to 216 poles and a maximum of 110 A / 1,000 V.

Fast wiring. But safe.

Choose from all common connection technologies including the PUSH IN direct plug-in technology and the brand new SNAP IN connection. The SNAP IN principle is particularly easy to use: The stripped conductor is inserted directly into open connection points and the snap connection snaps into place with a click.

PUSH IN

SNAP IN

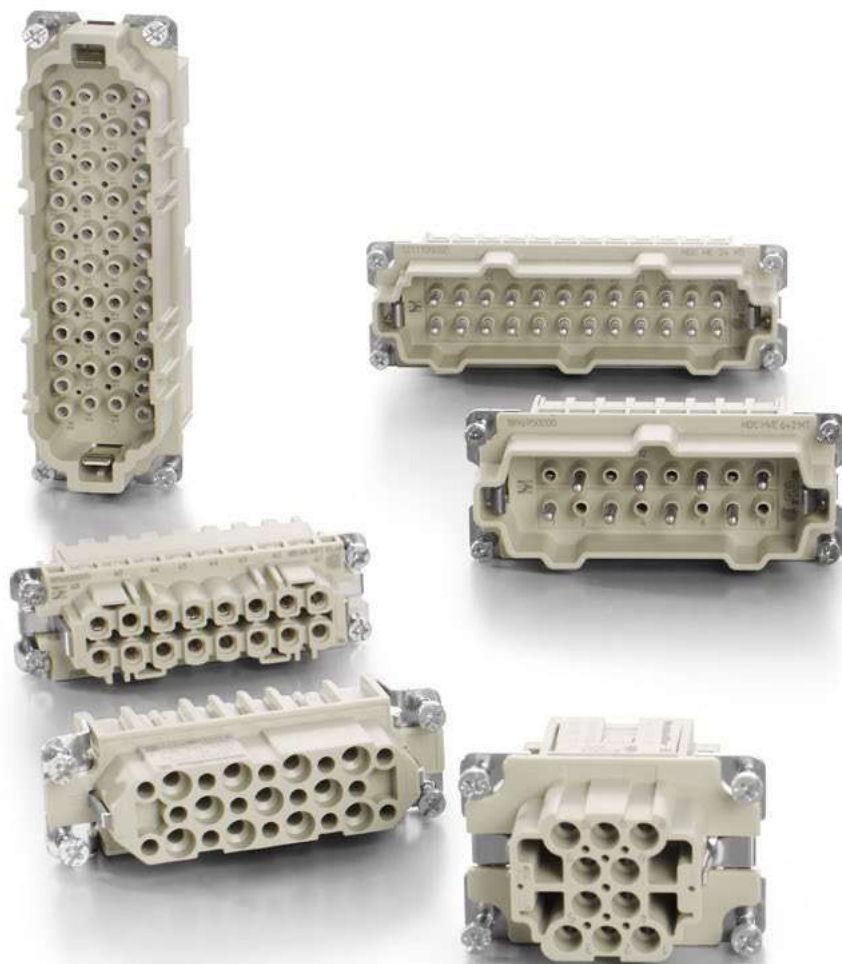

Consistency

One plastic material – with all approvals. This expands your range of choices. It also helps you to have simple documentation and reliable planning processes.

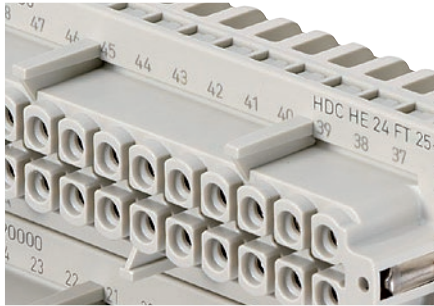
**Suitable**

Always according to your needs: including a space-saving combination of power and signals in one connector.

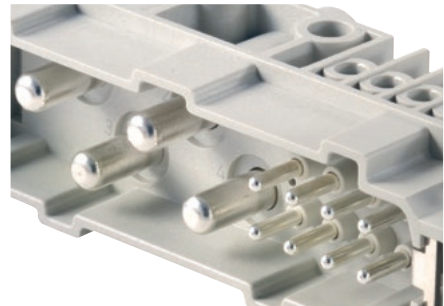

HA series

Compact: Our space-saving miracle among the fixed-pole inserts accommodates up to 48 contacts in suitable IP65 housings due to its particularly slim design.

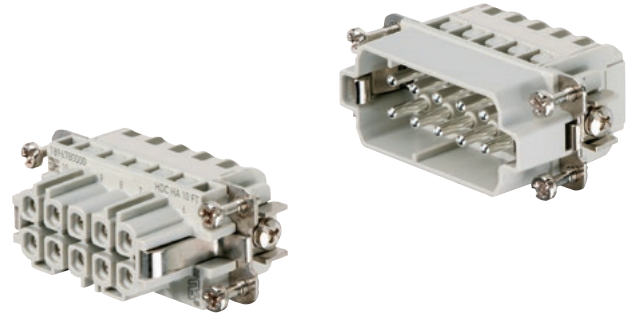













Technical data

Standards/approvals	
Standards	DIN EN 61984 DIN EN 60664-1
Approvals	UL/CSA**
Inserts	
No. of poles	3, 4, 10, 16, 32, 48
Rated voltage	250 V (400 V - HA3, HA4)
Rated voltage to UL/CSA	600 V
Rated current	16 A
Rated impulse withstand voltage	4 kV
Pollution severity	3 (320 V / 4 kV / 2) (HA10, 16, 32, 48)
Insulation resistance	$\geq 10^{10} \Omega$
Material	Glass-fibre reinforced PC (in UL list and approved for railway applications)
Temperature range	-40 °C to +125 °C
Flammability to UL 94	V-0
Mechanical service life	
- Plugging cycles Ag-Surface	≥ 500
- Plugging cycles Au-Surface	≥ 500
Contact resistance	
Crimp connection	$\leq 2 \text{ m}\Omega$
Screw connection, Tension clamp connection	$\leq 2 \text{ m}\Omega$
Contacts/Material	
Sockets and plug-in contact	Copper alloy
Surface	Passivated silver, or gold-plated
Clamping unit/Screw connection	Copper alloy/Passivated silver
Clamping range/Stripping length	
- Crimp connection*	0.5 - 2.5 mm ² (AWG 20 - 14) / 7.5 mm
- Screw connection	0.5 - 2.5 mm ² (AWG 20 - 14) / 9 mm***
- Tension clamp connection	0.25 - 2.5 mm ² (AWG 24 - 14) / 8 mm
Clamping torque	
- Screw connection	0.5 - 0.55 Nm
SD blades	
- Screw connection	0.6 x 3.5 or P20
- Tension clamp connection	0.5 x 3 or 0.6 x 3.5
PE connection	
- Clamping range	0.5 - 2.5 mm ²
- solid/stranded	0.5 - 2.5 mm ² / 0.5 - 2.5 mm ²
- flexible/flexible with wire end ferrule, DIN 46228 pt. 1	0.5 - 2.5 mm ² / 0.5 - 2.5 mm ²
- AWG conductor	AWG 20 - 14
- Stripping length	10 mm
- Clamping torque	1.2 - 1.5 Nm
- Blade dimensions	SD 0.8 x 4 mm or PZ1

Note:
When used properly and as designated, the listed connectors may not be connected or disconnected if there is a live voltage or load!

- * Crimping with flexible conductors
- ** For screw and crimp connections
- *** Stripping length of 15 mm for the 3- and 4-pole HA

Overview

		Size	Rated voltage	Rated current	No. of poles	Tension clamp connection	TOP connection	Screw conn. with wire guard spring	Crimp connection	PUSH IN connection	Page
		1	400 V	16 A	3 + ⊕		•				B.6
		1	400 V	16 A	4 + ⊕		•				B.8
		2	250 V	16 A	10 + ⊕	•		•	•		B.10
		5	250 V	16 A	16 + ⊕	•		•	•		B.12
		7	250 V	16 A	32 + ⊕	•		•	•		B.14
		9	250 V		48 + ⊕	•		•	•		B.16

400 V, 16A, size 1

3 + ⊕

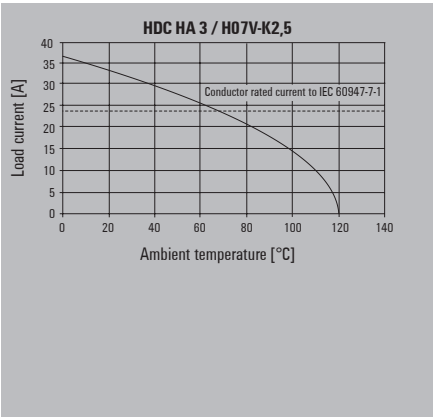

Male

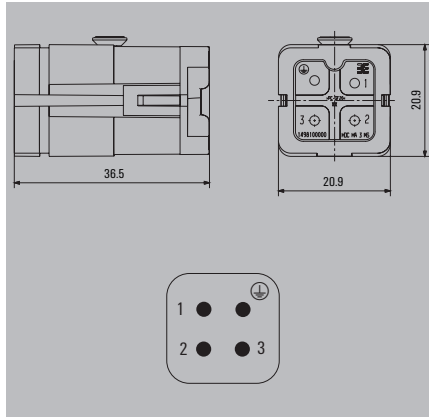

Ordering data

Type of connection	Type	Qty.	Order No.
Screw connection	HDC HA 3 MS	1	1498100000

Female

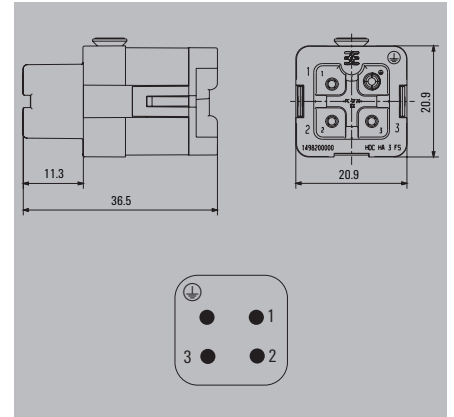

Ordering data

Type of connection	Type	Qty.	Order No.
Screw connection	HDC HA 3 FS	1	1498200000

Installation cut-out

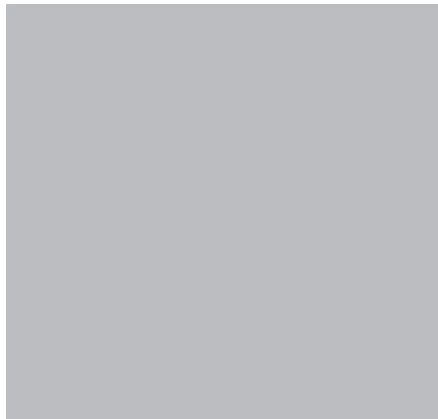

Housing selection RockStar® IP65
Size 1



For additional housings, refer to
Chapter D for IP65 / Chapter F for IP68 EMC

Hood

Plug housing, cable entry sideways



Material: diecast aluminium

a	Version	Cover	b (mm)	Type	Order No.
M 20	w. thread		49.2	HDC 04A TWLU 1M20G	1788810000

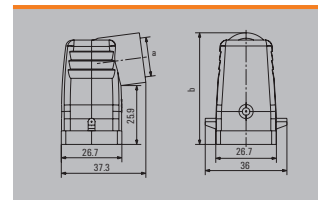

Plug housing, cable entry at top



Material: diecast aluminium

a	Version	Cover	b (mm)	Type	Order No.
M 20	w. thread		50	HDC 04A TOLU 1M20G	1788820000

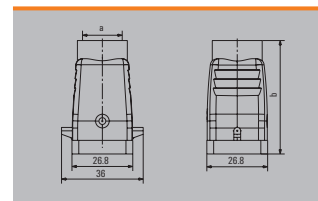

Base

Bulkhead housing



Material: diecast aluminium

Version	Cover	b (mm)	Type	Order No.
Side-locking		23	HDC 04A ALU	1497600000

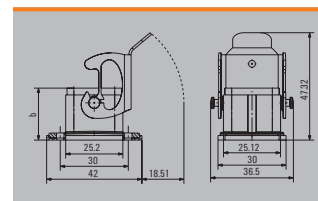

Base housing



Material: diecast aluminium

a	Version	Cover	b (mm)	Type	Order No.
M 20	Side-locking		41.5	HDC 04A SLU 1M20G	1788830000

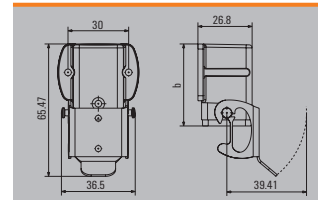

Coupling housing



Material: diecast aluminium

a	Version	Cover	b (mm)	Type	Order No.
M 20	w. thread		53.5	HDC 04A KOLU 1M20G	1788840000

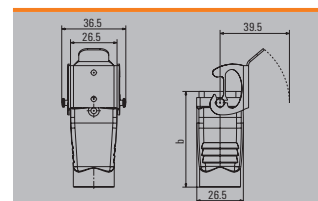

Screw mounting housing



Material: diecast aluminium

a	Version	Cover	b (mm)	Type	Order No.
M 20	w. thread		54	HDC 04A ELU 1M20G	1900320000

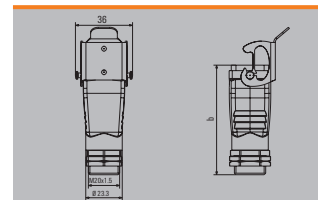

Cover



Material: diecast aluminium

Version	Type	Order No.
with female	HDC 04A DMDL 2B0	1665750000
with male	HDC 04A DDDL 2B0	1665740000

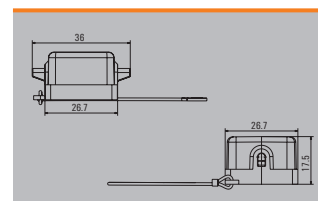

400 V, 16A, size 1

4 + ⊕

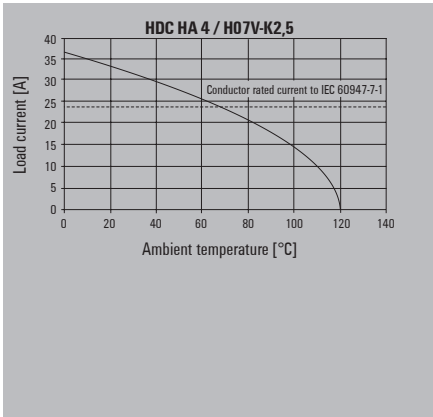

Male

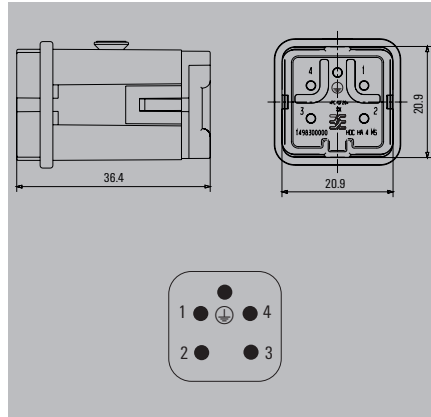

Ordering data

Type of connection	Type	Qty.	Order No.
Screw connection	HDC HA 4 MS	1	1498300000

Female

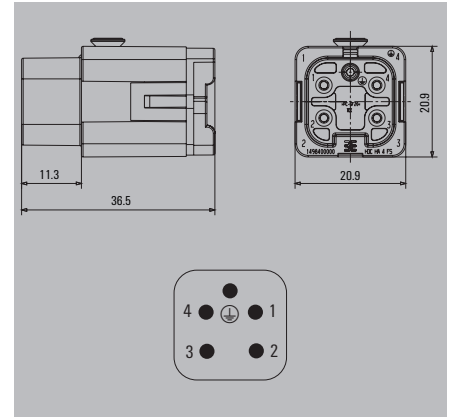

Ordering data

Type of connection	Type	Qty.	Order No.
Screw connection	HDC HA 4 FS	1	1498400000

Installation cut-out



Housing selection RockStar® IP65
Size 1



For additional housings, refer to
Chapter D for IP65 / Chapter F for IP68 EMC

Hood

Plug housing, cable entry sideways



Material: diecast aluminium

a	Version	Cover	b (mm)	Type	Order No.
M 20	w. thread		49.2	HDC 04A TWLU 1M20G	1788810000

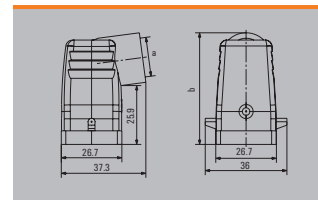

Plug housing, cable entry at top



Material: diecast aluminium

a	Version	Cover	b (mm)	Type	Order No.
M 20	w. thread		50	HDC 04A TOLU 1M20G	1788820000

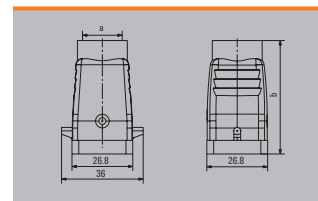

Base

Bulkhead housing



Material: diecast aluminium

Version	Cover	b (mm)	Type	Order No.
Side-locking		23	HDC 04A ALU	1497600000

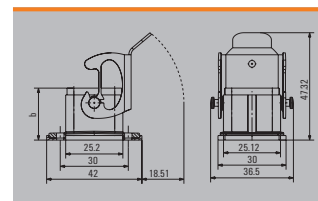

Base housing



Material: diecast aluminium

a	Version	Cover	b (mm)	Type	Order No.
M 20	Side-locking		41.5	HDC 04A SLU 1M20G	1788830000

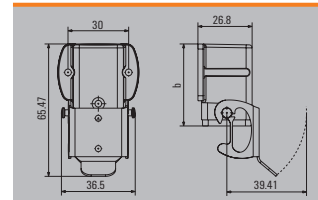

Coupling housing



Material: diecast aluminium

a	Version	Cover	b (mm)	Type	Order No.
M 20	w. thread		53.5	HDC 04A KOLU 1M20G	1788840000

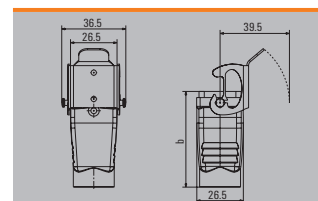

Screw mounting housing



Material: diecast aluminium

a	Version	Cover	b (mm)	Type	Order No.
M 20	w. thread		54	HDC 04A ELU 1M20G	1900320000

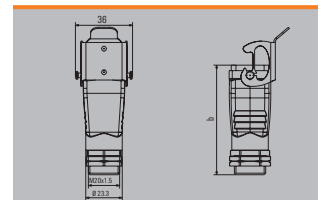

Cover



Material: diecast aluminium

Version	Type	Order No.
with female	HDC 04A DMDL 2B0	1665750000
with male	HDC 04A DDDL 2B0	1665740000

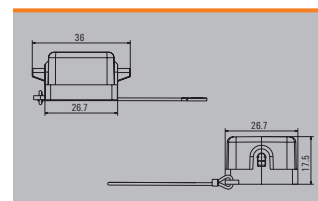

250V, 16 A, size 2

10 + ⊕

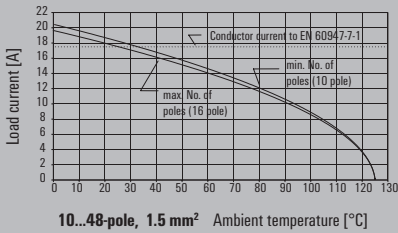

10...48-pole, 1.5 mm² Ambient temperature [°C]

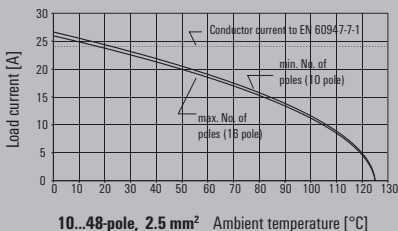

10...48-pole, 2.5 mm² Ambient temperature [°C]

Installation cut-out

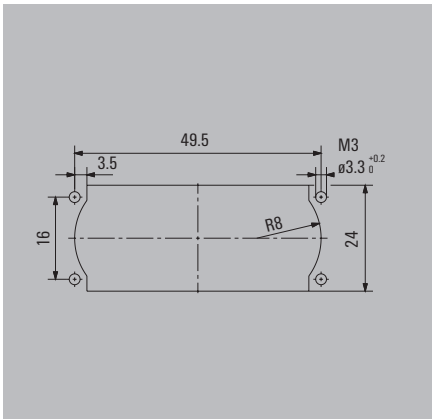

Male

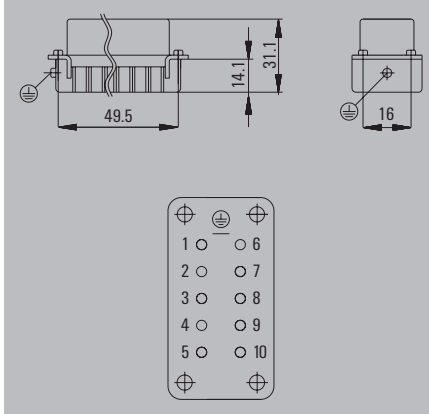
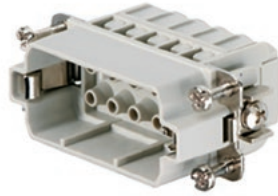

Ordering data

Type of connection	Type	Qty.	Order No.
Tension-clamp conn.	HDC HA 10 MT	1	1896790000
Screw connection	HDC HA 10 MS	1	1650610000
Crimp connection	HDC HA 10 MC	1	1873870000

Accessories

Type	Qty.	Order No.
Crimp contacts, male - gold		
HDC-C-HE-SM0.5AU	100	1651420000
HDC-C-HE-SM0.75-1.00AU	100	1651430000
HDC-C-HE-SM1.5AU	100	1651440000
HDC-C-HE-SM2.5AU	100	1651450000
HDC-C-HE-SM4.0AU	100	1651460000
Crimp contacts, male - silver		
HDC-C-HE-SM0.5AG	100	1200500000
HDC-C-HE-SM0.75-1.00AG	100	1200600000
HDC-C-HE-SM1.5AG	100	1200700000
HDC-C-HE-SM2.5AG	100	1200800000
HDC-C-HE-SM4.0AG	100	1200900000
Tools		
CTX CM 1.6/2.5	1	9018490000
REMOVAL TOOL HE	1	1866750000

Female

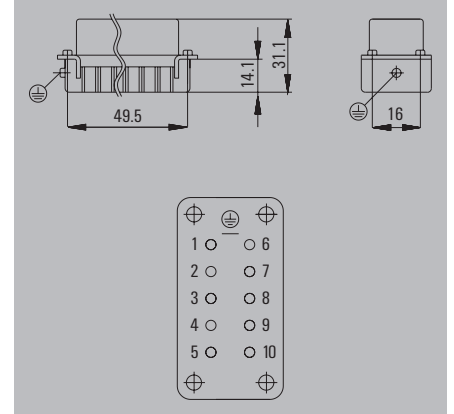

Ordering data

Type of connection	Type	Qty.	Order No.
Tension-clamp conn.	HDC HA 10 FT	1	1896780000
Screw connection	HDC HA 10 FS	1	1650620000
Crimp connection	HDC HA 10 FC	1	1873860000

Accessories

Type	Qty.	Order No.
Crimp contacts, female - gold		
HDC-C-HE-BM0.5AU	100	1651470000
HDC-C-HE-BM0.75-1.00AU	100	1651480000
HDC-C-HE-BM1.5AU	100	1651490000
HDC-C-HE-BM2.5AU	100	1651500000
HDC-C-HE-BM4.0AU	100	1651510000
Crimp contacts, female - silver		
HDC-C-HE-BM0.5AG	100	1201100000
HDC-C-HE-BM0.75-1.00AG	100	1201200000
HDC-C-HE-BM1.5AG	100	1201300000
HDC-C-HE-BM2.5AG	100	1201400000
HDC-C-HE-BM4.0AG	100	1201500000
Tools		
CTX CM 1.6/2.5	1	9018490000
REMOVAL TOOL HE	1	1866750000

Housing selection RockStar® IP65
Size 2



For additional housings, refer to chapter D for IP65

Hood

Plug housing, cable entry sideways



a	Version	Cover	b (mm)	Type	Order No.
M 20	w. thread		68	HDC 15A TSLU 1M20G	1788860000
M 25	w. thread		68	HDC 15A TSLU 1M25G	1788850000

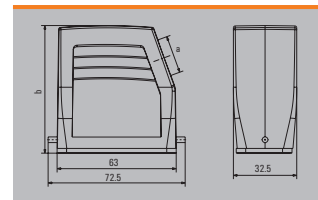

Plug housing, cable entry at top



a	Version	Cover	b (mm)	Type	Order No.
M 20	w. thread		54	HDC 10A TOLLU 1M20G	1788620000
M 25	w. thread		54	HDC 10A TOLLU 1M25G	1788610000

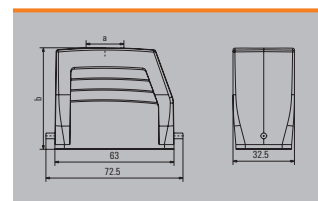

Cover



Version	Type	Order No.
For hoods	HDC 10A DDDL 1LB	1665890000

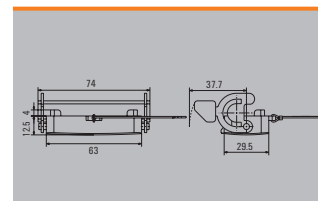

Base

Bulkhead housing



Version	Cover	b (mm)	Type	Order No.
End-locking	without cover	25	HDC 10A ALU	1664040000
End-locking	with cover	37.5	HDC 10A ADLU	1664060000

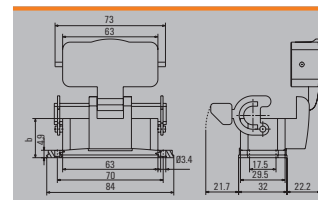

Base housing



a	Version	Cover	b (mm)	Type	Order No.
M 20	End-locking		57	HDC 10A SLU 2M20G	1788640000
M 20	End-locking	with cover	69.5	HDC 10A SDLU 2M20G	1788660000
M 25	End-locking		57	HDC 10A SLU 2M25G	1788630000
M 25	End-locking	with cover	69.5	HDC 10A SDLU 2M25G	1788650000

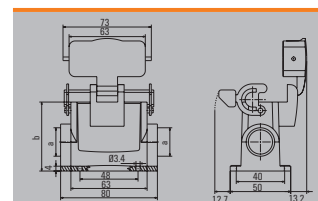

Coupling housing



a	Version	Cover	b (mm)	Type	Order No.
M 25	w. thread		48	HDC 10A KLU 1M25G	1788670000

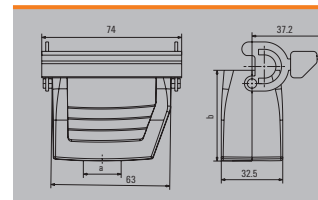

Cover



Version	Type	Order No.
For bases	HDC 10A DMDL 2B0	1665880000

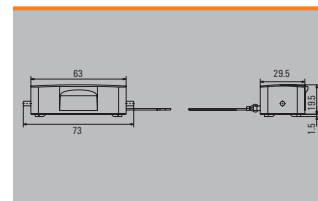

250V, 16 A, size 5

16 + ⊕

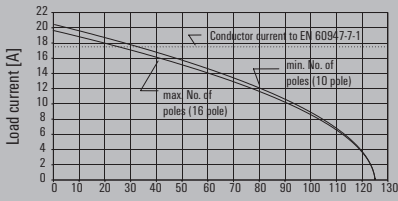

10...48-pole, 1.5 mm² Ambient temperature [°C]

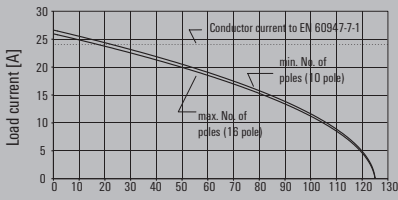

10...48-pole, 2.5 mm² Ambient temperature [°C]

Installation cut-out

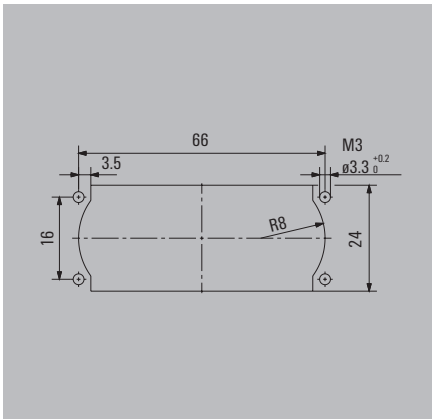

Male

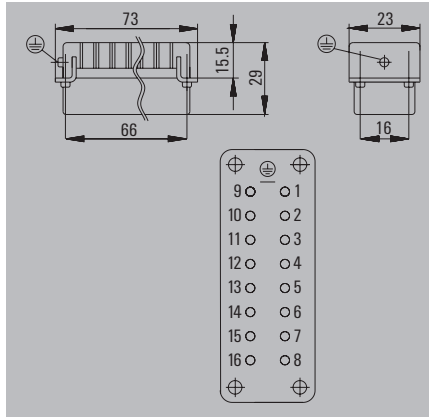

Ordering data

Type of connection	Type	Qty.	Order No.
Tension-clamp conn.	HDC HA 16 MT	1	1896830000
Screw connection	HDC HA 16 MS	1	1650770000
Crimp connection	HDC HA 16 MC	1	1873890000

Accessories

Type	Qty.	Order No.
Crimp contacts, male - gold		
HDC-C-HE-SM0.5AU	100	1651420000
HDC-C-HE-SM0.75-1.00AU	100	1651430000
HDC-C-HE-SM1.5AU	100	1651440000
HDC-C-HE-SM2.5AU	100	1651450000
HDC-C-HE-SM4.0AU	100	1651460000
Crimp contacts, male - silver		
HDC-C-HE-SM0.5AG	100	1200500000
HDC-C-HE-SM0.75-1.00AG	100	1200600000
HDC-C-HE-SM1.5AG	100	1200700000
HDC-C-HE-SM2.5AG	100	1200800000
HDC-C-HE-SM4.0AG	100	1200900000
Tools		
CTX CM 1.6/2.5	1	9018490000
REMOVAL TOOL HE	1	1866750000

Female

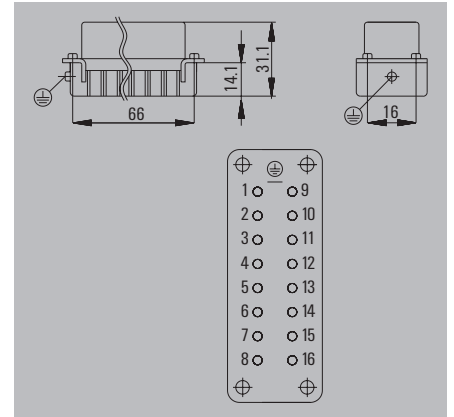
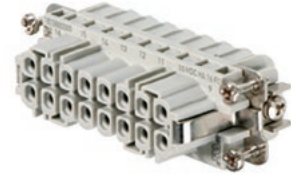

Ordering data

Type of connection	Type	Qty.	Order No.
Tension-clamp conn.	HDC HA 16 FT	1	1896800000
Screw connection	HDC HA 16 FS	1	1650780000
Crimp connection	HDC HA 16 FC	1	1873880000

Accessories

Type	Qty.	Order No.
Crimp contacts, female - gold		
HDC-C-HE-BM0.5AU	100	1651470000
HDC-C-HE-BM0.75-1.00AU	100	1651480000
HDC-C-HE-BM1.5AU	100	1651490000
HDC-C-HE-BM2.5AU	100	1651500000
HDC-C-HE-BM4.0AU	100	1651510000
Crimp contacts, female - silver		
HDC-C-HE-BM0.5AG	100	1201100000
HDC-C-HE-BM0.75-1.00AG	100	1201200000
HDC-C-HE-BM1.5AG	100	1201300000
HDC-C-HE-BM2.5AG	100	1201400000
HDC-C-HE-BM4.0AG	100	1201500000
Tools		
CTX CM 1.6/2.5	1	9018490000
REMOVAL TOOL HE	1	1866750000

Housing selection RockStar® IP65
Size 5



For additional housings, refer to chapter D for IP65

Hood

Plug housing, cable entry sideways



a	Version	Cover	b (mm)	Type	Order No.
M 20	w. thread		72	HDC 25A TSLU 1M20G	1788680000
M 25	w. thread		58	HDC 16A TSLU 1M25G	1788740000
M 25	w. thread		72	HDC 25A TSLU 1M25G	1788690000

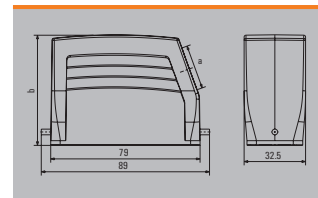

Plug housing, cable entry at top



a	Version	Cover	b (mm)	Type	Order No.
M 20	w. thread		72	HDC 25A TOLU 1M20G	1788710000
M 25	w. thread		58	HDC 16A TOLU 1M25G	1788750000
M 25	w. thread		72	HDC 25A TOLU 1M25G	1788700000

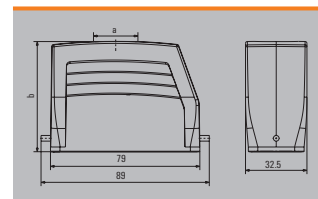

Cover



Version	Type	Order No.
For hoods	HDC 16A DDDL 1LB	1665900000

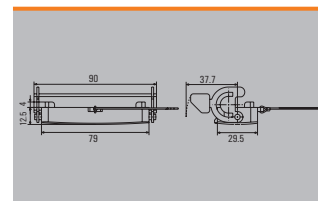

Base

Bulkhead housing



Version	Cover	b (mm)	Type	Order No.
End-locking	without cover	26.25	HDC 16A ALU	1664920000
End-locking	with cover	26.25	HDC 16A ADLU	1664940000

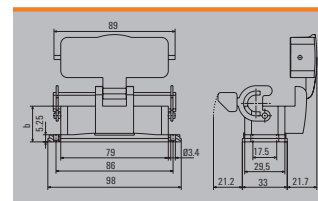

Base housing



a	Version	Cover	b (mm)	Type	Order No.
M 20	End-locking		57	HDC 16A SLU 2M20G	1788770000
M 20	End-locking	with cover	57	HDC 16A SDLU 2M20G	1788790000
M 25	End-locking		57	HDC 16A SLU 2M25G	1788760000
M 25	End-locking	with cover	57	HDC 16A SDLU 2M25G	1788780000

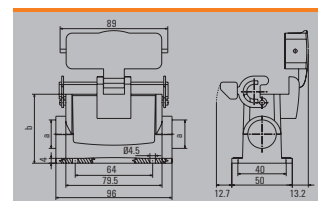

Coupling housing



a	Version	Cover	b (mm)	Type	Order No.
M 25	w. thread		52.62	HDC 16A KLU 1M25G	1788800000

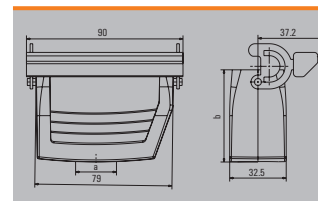

Cover



Version	Type	Order No.
For bases	HDC 16A DMDL 2B0	1665910000

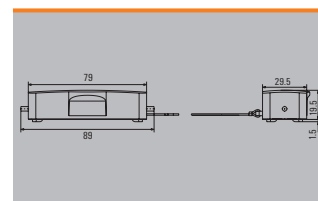

250 V, 16 A, size 7

32 + ⊕

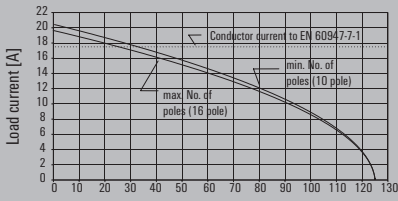

10...48-pole, 1.5 mm² Ambient temperature [°C]

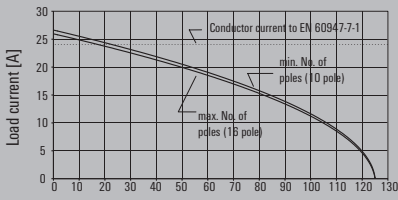

10...48-pole, 2.5 mm² Ambient temperature [°C]

Installation cut-out

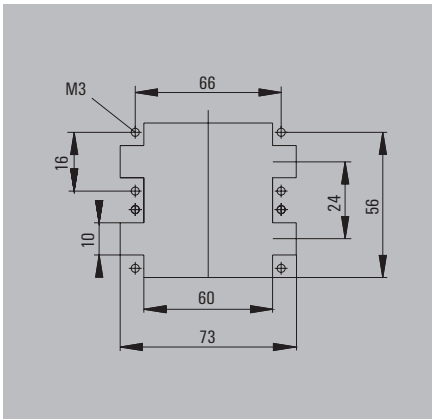

Male

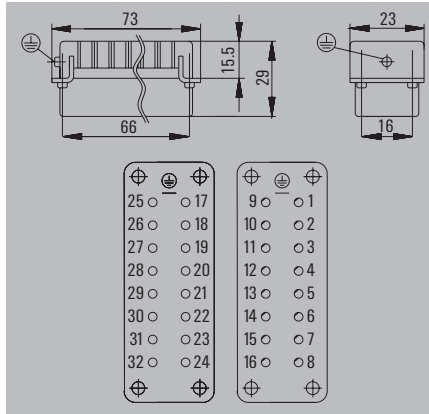

Ordering data

Type of connection	Type	Qty.	Order No.
Tension-clamp conn.	HDC HA 16 MT	1	1896830000
Tension-clamp conn.	HDC HA 16 MT 17-32	1	1896840000
Screw connection	HDC HA 16 MS	1	1650770000
Screw connection	HDC HA 16 MS 17-32	1	1650880000
Crimp connection	HDC HA 16 MC	1	1873890000
Crimp connection	HDC HA 16 MC 17-32	1	1875620000

Accessories

Type	Qty.	Order No.
Crimp contacts, male - gold		
HDC-C-HE-SM0.5AU	100	1651420000
HDC-C-HE-SM0.75-1.00AU	100	1651430000
HDC-C-HE-SM1.5AU	100	1651440000
HDC-C-HE-SM2.5AU	100	1651450000
HDC-C-HE-SM4.0AU	100	1651460000
Crimp contacts, male - silver		
HDC-C-HE-SM0.5AG	100	1200500000
HDC-C-HE-SM0.75-1.00AG	100	1200600000
HDC-C-HE-SM1.5AG	100	1200700000
HDC-C-HE-SM2.5AG	100	1200800000
HDC-C-HE-SM4.0AG	100	1200900000
Tools		
CTX CM 1.6/2.5	1	9018490000
REMOVAL TOOL HE	1	1866750000

Female

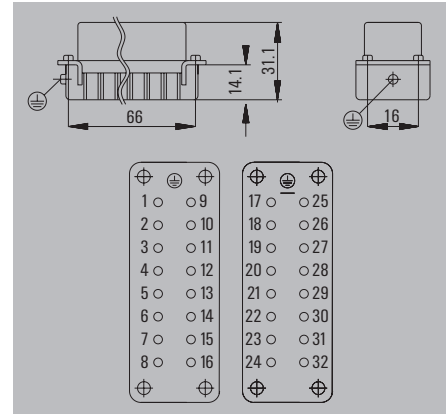

Ordering data

Type of connection	Type	Qty.	Order No.
Tension-clamp conn.	HDC HA 16 FT	1	1896800000
Tension-clamp conn.	HDC HA 16 FT 17-32	1	1896810000
Screw connection	HDC HA 16 FS	1	1650780000
Screw connection	HDC HA 16 FS 17-32	1	1650900000
Crimp connection	HDC HA 16 FC	1	1873880000
Crimp connection	HDC HA 16 FC 17-32	1	1876040000

Accessories

Type	Qty.	Order No.
Crimp contacts, female - gold		
HDC-C-HE-BM0.5AU	100	1651470000
HDC-C-HE-BM0.75-1.00AU	100	1651480000
HDC-C-HE-BM1.5AU	100	1651490000
HDC-C-HE-BM2.5AU	100	1651500000
HDC-C-HE-BM4.0AU	100	1651510000
Crimp contacts, female - silver		
HDC-C-HE-BM0.5AG	100	1201100000
HDC-C-HE-BM0.75-1.00AG	100	1201200000
HDC-C-HE-BM1.5AG	100	1201300000
HDC-C-HE-BM2.5AG	100	1201400000
HDC-C-HE-BM4.0AG	100	1201500000
Tools		
CTX CM 1.6/2.5	1	9018490000
REMOVAL TOOL HE	1	1866750000

Housing selection RockStar® IP65
Size 7



For additional housings, refer to chapter D for IP65

Hood

Plug housing, cable entry sideways



a	Version	Cover	b (mm)	Type	Order No.
M 25	w. thread		77	HDC 32A TSBU 1M25G	1787960000
M 32	w. thread		77	HDC 32A TSBU 1M32G	1787950000

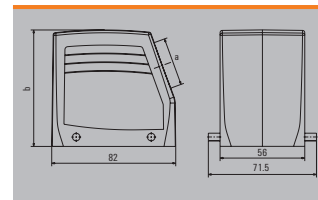

Plug housing, cable entry at top



a	Version	Cover	b (mm)	Type	Order No.
M 32	w. thread		77	HDC 32A TOBU 1M32G	1787990000

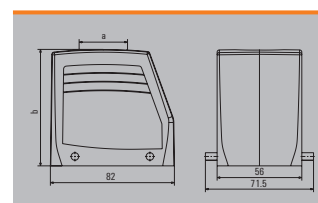

Base

Bulkhead housing



Version	Cover	b (mm)	Type	Order No.
Side-locking		30	HDC 32A ABU	1665860000

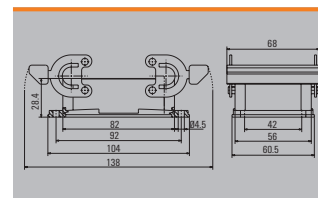

Base housing



a	Version	Cover	b (mm)	Type	Order No.
M 25	Side-locking		75	HDC 32A SBU 2M25G	1788040000

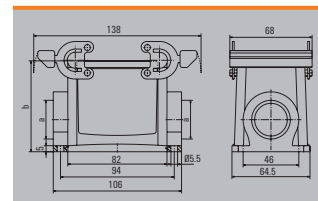

Coupling housing



a	Version	Cover	b (mm)	Type	Order No.
M 25	w. thread		77	HDC 32A KBU 1M25G	1788080000
M 32	w. thread		77	HDC 32A KBU 1M32G	1788070000

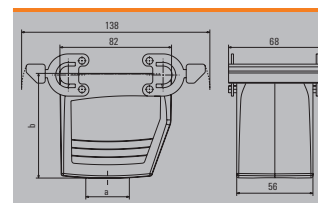

250 V, 16 A, size 9

48 + ⊕

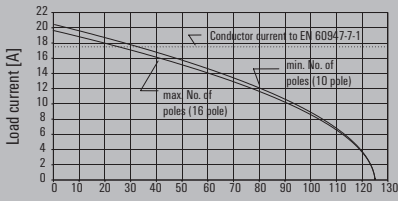

10...48-pole, 1.5 mm² Ambient temperature [°C]

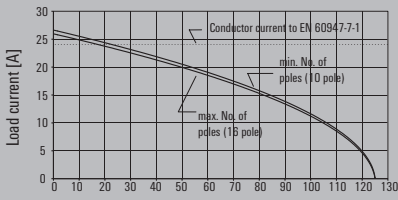

10...48-pole, 2.5 mm² Ambient temperature [°C]

Installation cut-out

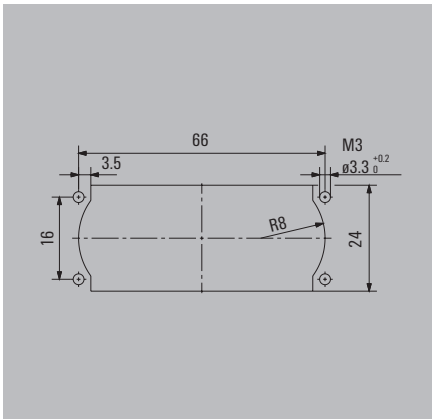

Male

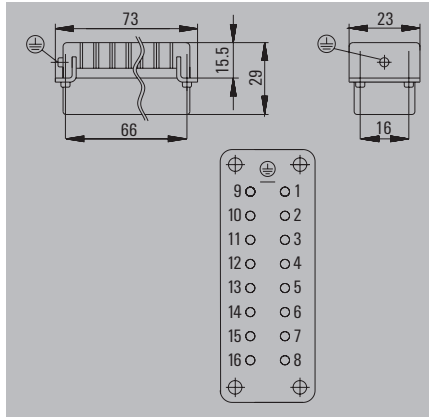

Female

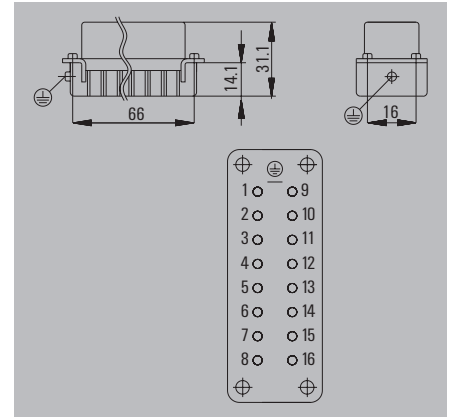
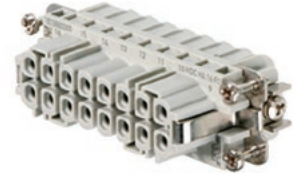

Ordering data

Type of connection	Type	Qty.	Order No.
Tension-clamp conn.	HDC HA 16 MT	1	1896830000
Tension-clamp conn.	HDC HA 16 MT 17-32	1	1896840000
Tension-clamp conn.	HDC HA 16 MT 33-48	1	1896850000
Screw connection	HDC HA 16 MS	1	1650770000
Screw connection	HDC HA 16 MS 17-32	1	1650880000
Screw connection	HDC HA 16 MS 33-48	1	1650990000
Crimp connection	HDC HA 16 MC	1	1873890000
Crimp connection	HDC HA 16 MC 17 - 32	1	1875620000

Ordering data

Type of connection	Type	Qty.	Order No.
Tension-clamp conn.	HDC HA 16 FT	1	1896800000
Tension-clamp conn.	HDC HA 16 FT 17-32	1	1896810000
Tension-clamp conn.	HDC HA 16 FT 33-48	1	1896820000
Screw connection	HDC HA 16 FS	1	1650780000
Screw connection	HDC HA 16 FS 17-32	1	1650900000
Screw connection	HDC HA 16 FS 33-48	1	1651020000
Crimp connection	HDC HA 16 FC	1	1873880000
Crimp connection	HDC HA 16 FC 17 - 32	1	1876040000

Accessories

Type	Qty.	Order No.
Crimp contacts, male - gold		
HDC-C-HE-SM0.5AU	100	1651420000
HDC-C-HE-SM0.75-1.00AU	100	1651430000
HDC-C-HE-SM1.5AU	100	1651440000
HDC-C-HE-SM2.5AU	100	1651450000
HDC-C-HE-SM4.0AU	100	1651460000
Crimp contacts, male - silver		
HDC-C-HE-SM0.5AG	100	1200500000
HDC-C-HE-SM0.75-1.00AG	100	1200600000
HDC-C-HE-SM1.5AG	100	1200700000
HDC-C-HE-SM2.5AG	100	1200800000
HDC-C-HE-SM4.0AG	100	1200900000
Tools		
CTX CM 1.6/2.5	1	9018490000
REMOVAL TOOL HE	1	1866750000

Accessories

Type	Qty.	Order No.
Crimp contacts, female - gold		
HDC-C-HE-BM0.5AU	100	1651470000
HDC-C-HE-BM0.75-1.00AU	100	1651480000
HDC-C-HE-BM1.5AU	100	1651490000
HDC-C-HE-BM2.5AU	100	1651500000
HDC-C-HE-BM4.0AU	100	1651510000
Crimp contacts, female - silver		
HDC-C-HE-BM0.5AG	100	1201100000
HDC-C-HE-BM0.75-1.00AG	100	1201200000
HDC-C-HE-BM1.5AG	100	1201300000
HDC-C-HE-BM2.5AG	100	1201400000
HDC-C-HE-BM4.0AG	100	1201500000
Tools		
CTX CM 1.6/2.5	1	9018490000
REMOVAL TOOL HE	1	1866750000

Housing selection RockStar® IP65
Size 9



For additional housings, refer to chapter D for IP65

Hood

Plug housing, cable entry sideways



a	Version	Cover	b (mm)	Type	Order No.
M 32	w. thread		78	HDC 48A TSLU 1M32G	1788550000

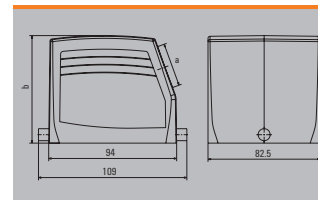

Plug housing, cable entry at top



a	Version	Cover	b (mm)	Type	Order No.
M 32	w. thread		78	HDC 48A TOLU 1M32G	1788560000

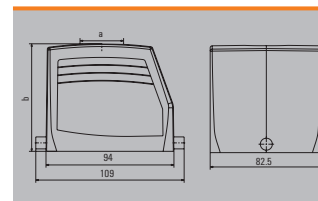

Base

Bulkhead housing



Version	Cover	b (mm)	Type	Order No.
End-locking	without cover	40	HDC 48A ALU	1666740000
End-locking	with cover	40	HDC 48A ADLU	1666750000

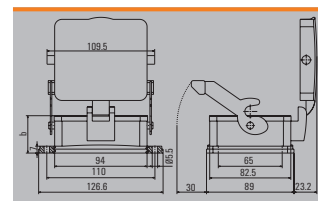

Base housing



a	Version	Cover	b (mm)	Type	Order No.
M 32	End-locking		79	HDC 48A SLU 2M32G	1788570000

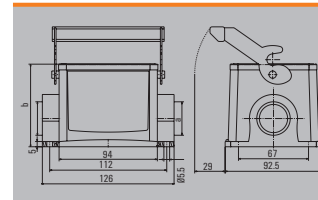

HE series

Powerful and convenient: HE/HEE inserts enable efficient signal transmission of up to 48 contacts at maximum 16 A and 500 V. They are also now available with the innovative SNAP IN connector.

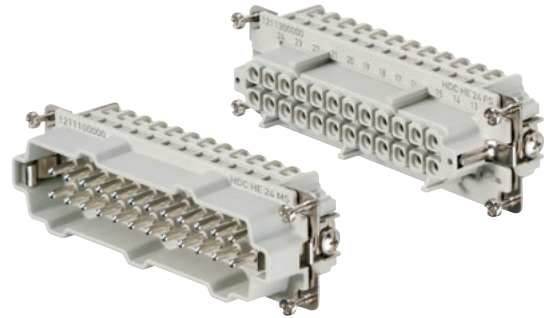

Technical data

Standards/approvals	
Standards	DIN EN 61984 DIN EN 60664-1
Approvals	UL/CSA**, ISO 23570 (DESINA)*
Inserts	
No. of poles	6, 10, 16, 24, 32, 48
Rated voltage	500 V
Rated voltage to UL/CSA	600 V
Rated current	16 A (6 poles 24 A)
Rated impulse withstand voltage	6 kV
Pollution severity	3 (630 V / 6 kV / 2)
Insulation resistance	$\geq 10^{10} \Omega$
Material	Glass-fibre reinforced PC (in UL list and approved for railway applications)
Temperature range	-40 °C to +125 °C
Flammability to UL 94	V-0
Mechanical service life	
- Plugging cycles Ag-Surface	≥ 500
- Plugging cycles Au-Surface	≥ 500
Contact resistance	$\leq 2 \text{ m}\Omega$
Contacts/Material	
Contacts	Copper alloy
Surface	Passivated silver, or gold-plated
Clamping range/Stripping length	
- Crimp connection	
- stranded/flexible	0.5 - 4.0 mm ² / 0.5 - 4.0 mm ² (AWG 20 - 12) / 7.5 mm
- Screw connection	
- solid/stranded	0.5 - 2.5 mm ² / 0.5 - 2.5 mm ² (AWG 20 - 14) / 9 mm
- flexible/flexible with wire end ferrule	0.5 - 2.5 mm ² / 0.5 - 2.5 mm ² (AWG 20 - 14) / 9 mm
- Tension clamp connection	
- solid/stranded	0.25...2.5 mm ² / (AWG 24...14) / 8 mm
- flexible/flexible with wire end ferrule	0.25...2.5 mm ² / (AWG 24...14) / 8 mm
- PUSH IN	
- solid	0.5...4 mm ² (AWG 20...12) / 10 mm
- flexible with wire end ferrule without collar	0.5...2.5 mm ² (AWG 20...14) / 12 mm
- SnapIn	
- flexible/stranded	1...2.5 mm ² (AWG 20...16) / 10
- flexible with wire end ferrule	1...2.5 mm ² (AWG 20...16) / 10
Clamping torque	
- Screw connection	0.5 - 0.55 Nm
SD blades	
- Screw connection	0.6 x 3.5 oder PZ0
- PUSH IN	0.4 x 2.5
- Tension clamp connection	0.5 x 3 oder 0.6 x 3.5
- SnapIn	0.6 x 3.5

Note:

* The HE 10 inserts are included in the ISO 23570 as motor terminal connectors.
** For screw, crimp, and PUSH IN connections

Contacts/Material













PE connection

- Clamping range	0.5 - 4 mm ²
- solid/stranded	0.5 - 4 mm ² / 0.5 - 4 mm ²
- flexible/flexible with wire end ferrule, DIN 46228 pt. 1	0.5 - 4 mm ² / 0.5 - 4 mm ²
- AWG conductor	AWG 20 - 12
- Stripping length	10 mm
- Clamping torque	1.2 - 1.5 Nm
- Blade dimensions	SD 0.8 x 4 mm or PZ1

Note:

When used properly and as designated, the listed connectors may not be connected or disconnected if there is a live voltage or load!
Inserts with PUSH IN connection can be connected to the H07V-U4 conductor.

Overview

		Size	Rated voltage	Rated current	No. of poles	Tension clamp connection	Screw conn. with wire guard spring	Crimp connection	PUSH IN connection	SNAP IN connection	Page
		3	500 V	24 A	6 + ⊕	•	•	•	•	•	B.20
		4	500 V	16 A	10 + ⊕	•	•	•	•	•	B.22
		6	500 V	16 A	16 + ⊕	•	•	•	•	•	B.24
		8	500 V	16 A	24 + ⊕	•	•	•	•	•	B.26
		10	500 V	16 A	32 + ⊕	•	•	•	•	•	B.28
		12	500 V	16 A	48 + ⊕	•	•	•	•	•	B.30

500 V, 24 A, size 3

6 + ⊕

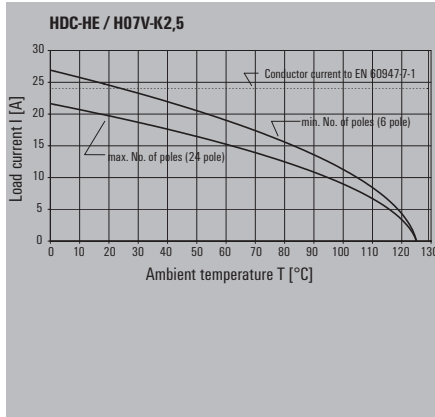
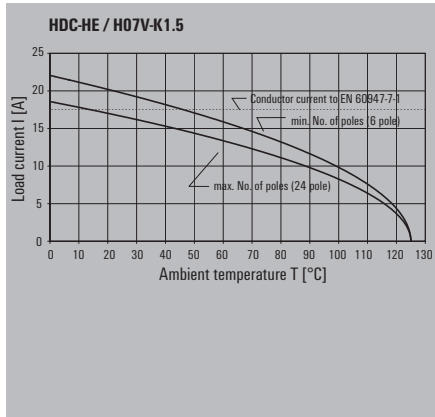

Installation cut-out

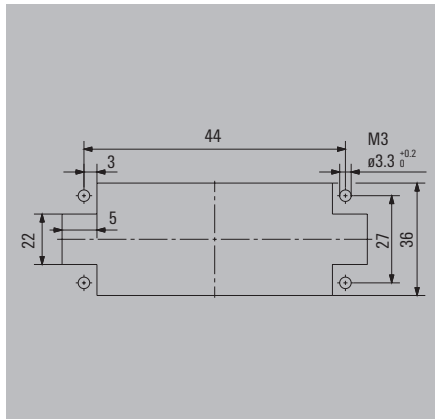

Male

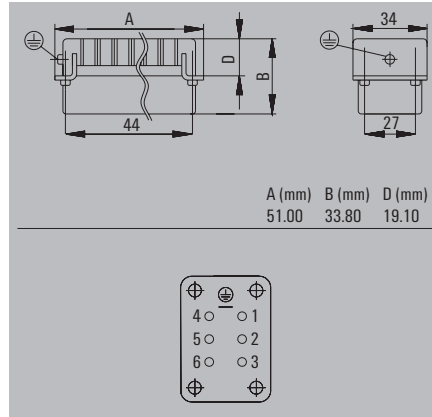

Ordering data

Type of connection	Type	Qty.	Order No.
Tension-clamp conn.	HDC HE 6 MT	1	1745820000
Screw connection	HDC HE 6 MS	1	1200000000
PUSH IN	HDC HE 6 MP	1	1873530000
Crimp connection	HDC HE 6 MC	1	1200400000
SNAP IN	HDC HE 6 MQT	1	2666910000

Accessories

Type	Qty.	Order No.
Crimp contacts, male - gold		
HDC-C-HE-SM0.5AU	100	1651420000
HDC-C-HE-SM0.75-1.00AU	100	1651430000
HDC-C-HE-SM1.5AU	100	1651440000
HDC-C-HE-SM2.5AU	100	1651450000
HDC-C-HE-SM4.0AU	100	1651460000
Crimp contacts, male - silver		
HDC-C-HE-SM0.5AG	100	1200500000
HDC-C-HE-SM0.75-1.00AG	100	1200600000
HDC-C-HE-SM1.5AG	100	1200700000
HDC-C-HE-SM2.5AG	100	1200800000
HDC-C-HE-SM4.0AG	100	1200900000
Tools		
CTX CM 1.6/2.5	1	9018490000
REMOVAL TOOL HE	1	1866750000

Female

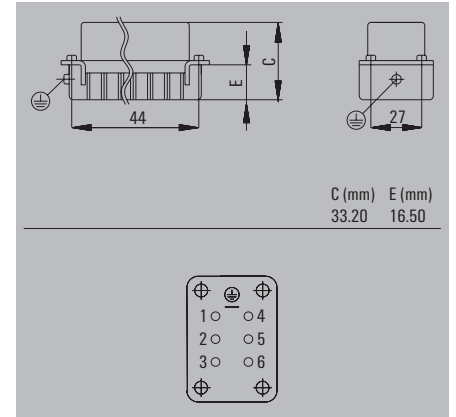

Ordering data

Type of connection	Type	Qty.	Order No.
Tension-clamp conn.	HDC HE 6 FT	1	1745760000
Screw connection	HDC HE 6 FS	1	1200200000
PUSH IN	HDC HE 6 FP	1	1873520000
Crimp connection	HDC HE 6 FC	1	1201000000
SNAP IN	HDC HE 06 FQT	1	2666920000

Accessories

Type	Qty.	Order No.
Crimp contacts, female - gold		
HDC-C-HE-BM0.5AU	100	1651470000
HDC-C-HE-BM0.75-1.00AU	100	1651480000
HDC-C-HE-BM1.5AU	100	1651490000
HDC-C-HE-BM2.5AU	100	1651500000
HDC-C-HE-BM4.0AU	100	1651510000
Crimp contacts, female - silver		
HDC-C-HE-BM0.5AG	100	1201100000
HDC-C-HE-BM0.75-1.00AG	100	1201200000
HDC-C-HE-BM1.5AG	100	1201300000
HDC-C-HE-BM2.5AG	100	1201400000
HDC-C-HE-BM4.0AG	100	1201500000
Tools		
CTX CM 1.6/2.5	1	9018490000
REMOVAL TOOL HE	1	1866750000

Housing selection RockStar® IP65 Size 3



For additional housings, refer to
Chapter D for IP65 / Chapter E for IP65 EMC /
Chapter F for IP68 EMC

Hood

Plug housing, cable entry sideways



a	Version	Cover	b (mm)	Type	Order No.
M 20	w. thread		52	HDC 06B TSLU 1M20G	1788100000
M 25	w. thread		52	HDC 06B TSLU 1M25G	1788090000
M 25	w. thread		72	HDC 16D TSLU 1M25G	1787480000

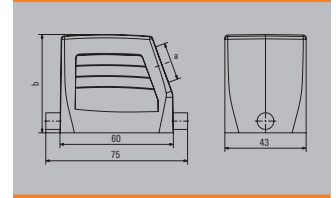

Plug housing, cable entry at top



a	Version	Cover	b (mm)	Type	Order No.
M 20	w. thread		52	HDC 06B TOLU 1M20G	1788120000
M 25	w. thread		52	HDC 06B TOLU 1M25G	1788110000
M 25	w. thread		72	HDC 16D TOLU 1M25G	1787500000
M 32	w. thread		72	HDC 16D TOLU 1M32G	1787490000

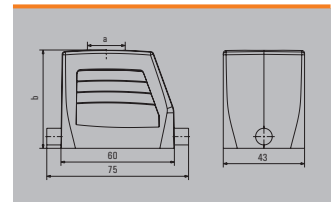

Cover



Version	Type	Order No.
For hoods	HDC 06B DMDL 1LB	1665210000
For hoods	HDC 06B DMDL 1LB N	2559730000

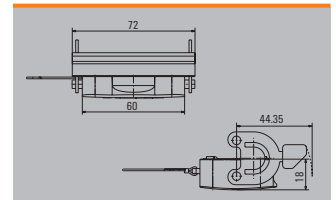

Note Note: N = Plastic locking lever with stainless steel inlay

Base

Bulkhead housing



Version	Cover	b (mm)	Type	Order No.
End-locking	without cover	29.3	HDC 06B ALU	1202100000
End-locking		29.3	HDC 06B ALU N	2488560000
End-locking	with cover	29.3	HDC 06B ADLU	1202500000
End-locking	with cover	29.3	HDC 06B ADLU N	2559320000

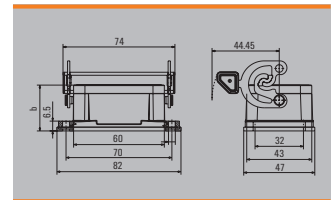

Note Note: N = Plastic locking lever with stainless steel inlay

Base housing



a	Version	Cover	b (mm)	Type	Order No.
M 20	End-locking		54	HDC 06B SLU 1M20G N	2637080000
M 20	End-locking	with cover	54	HDC 06B SDLU 1M20G N	2560720000
M 20	End-locking		54	HDC 06B SLU 2M20G	1788140000
M 20	End-locking	with cover	54	HDC 06B SDLU 2M20G	1788170000
M 25	End-locking		54	HDC 06B SLU 2M25G	1788130000
M 25	End-locking	without cover	54	HDC 06B SLU 2M25G N	2560860000
M 25	End-locking	with cover	54	HDC 06B SDLU 2M25G	1788160000
M 25	End-locking	with cover	54	HDC 06B SDLU 2M25G N	2560830000

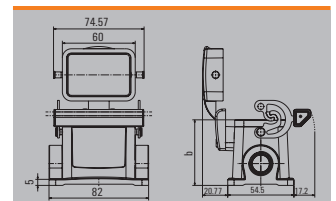

Note Note: N = Plastic locking lever with stainless steel inlay

Cover



Version	Type	Order No.
For bases	HDC 06B DDDL 2B0	1665200000

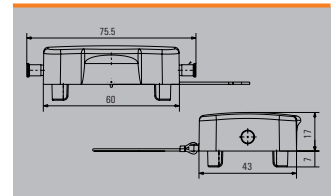

500 V, 16 A, size 4

10 + ⊕

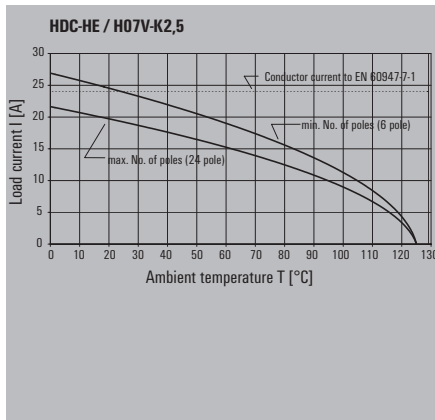
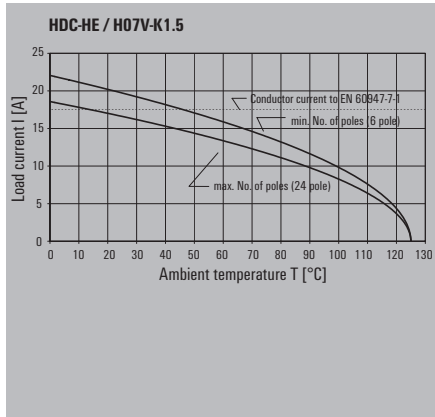

Installation cut-out

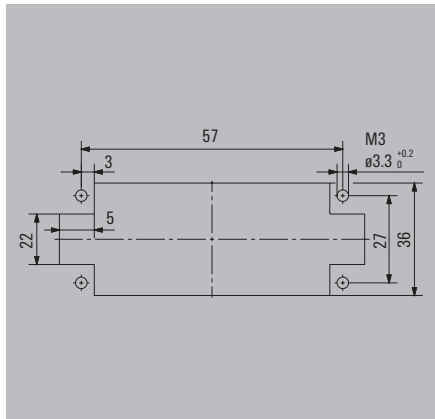

Male

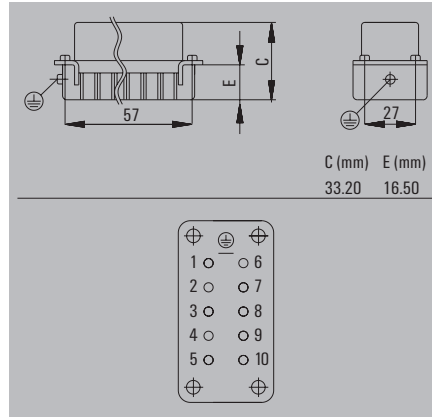

Ordering data

Type of connection	Type	Qty.	Order No.
Tension-clamp conn.	HDC HE 10 MT	1	1745830000
Screw connection	HDC HE 10 MS	1	1203900000
PUSH IN	HDC HE 10 MP	1	1873550000
Crimp connection	HDC HE 10 MC	1	1204300000
SNAP IN	HDC HE 10 MQT	1	2666940000

Accessories

Type	Qty.	Order No.
Crimp contacts, male - gold		
HDC-C-HE-SM0.5AU	100	1651420000
HDC-C-HE-SM0.75-1.00AU	100	1651430000
HDC-C-HE-SM1.5AU	100	1651440000
HDC-C-HE-SM2.5AU	100	1651450000
HDC-C-HE-SM4.0AU	100	1651460000
Crimp contacts, male - silver		
HDC-C-HE-SM0.5AG	100	1200500000
HDC-C-HE-SM0.75-1.00AG	100	1200600000
HDC-C-HE-SM1.5AG	100	1200700000
HDC-C-HE-SM2.5AG	100	1200800000
HDC-C-HE-SM4.0AG	100	1200900000
Tools		
CTX CM 1.6/2.5	1	9018490000
REMOVAL TOOL HE	1	1866750000

Female

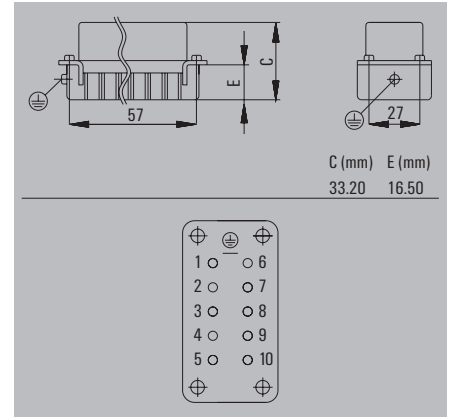
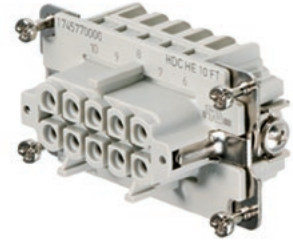

Ordering data

Type of connection	Type	Qty.	Order No.
Tension-clamp conn.	HDC HE 10 FT	1	1745770000
Screw connection	HDC HE 10 FS	1	1204100000
PUSH IN	HDC HE 10 FP	1	1873540000
Crimp connection	HDC HE 10 FC	1	1204400000
SNAP IN	HDC HE 10 FQT	1	2666930000

Accessories

Type	Qty.	Order No.
Crimp contacts, female - gold		
HDC-C-HE-BM0.5AU	100	1651470000
HDC-C-HE-BM0.75-1.00AU	100	1651480000
HDC-C-HE-BM1.5AU	100	1651490000
HDC-C-HE-BM2.5AU	100	1651500000
HDC-C-HE-BM4.0AU	100	1651510000
Crimp contacts, female - silver		
HDC-C-HE-BM0.5AG	100	1201100000
HDC-C-HE-BM0.75-1.00AG	100	1201200000
HDC-C-HE-BM1.5AG	100	1201300000
HDC-C-HE-BM2.5AG	100	1201400000
HDC-C-HE-BM4.0AG	100	1201500000
Tools		
CTX CM 1.6/2.5	1	9018490000
REMOVAL TOOL HE	1	1866750000

Housing selection RockStar® IP65
Size 4



For additional housings, refer to
Chapter D for IP65 / Chapter E for IP65 EMC /
Chapter F for IP68 EMC

Hood

Plug housing, cable entry sideways



a	Version	Cover	b (mm)	Type	Order No.
M 20	w. thread		52	HDC 10B TSBU 1M20G	1787560000
M 25	w. thread		52	HDC 10B TSBU 1M25G	1787550000
M 25	w. thread		72	HDC 24D TSBU 1M25G	1787240000
M 32	w. thread		72	HDC 24D TSBU 1M32G	1787230000

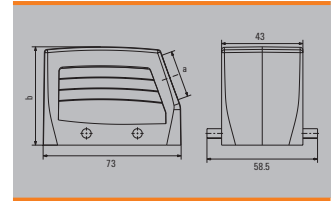

Plug housing, cable entry at top



a	Version	Cover	b (mm)	Type	Order No.
M 20	w. thread		52	HDC 10B TOBU 1M20G	1787600000
M 25	w. thread		52	HDC 10B TOBU 1M25G	1787590000
M 25	w. thread		72	HDC 24D TOBU 1M25G	1787300000
M 32	w. thread		72	HDC 24D TOBU 1M32G	1787290000

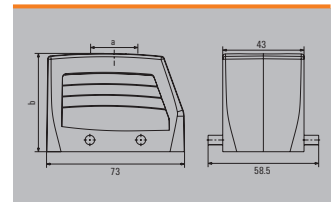

Cover



Version	Type	Order No.
For hoods	HDC 10B DMDQ 2QB	1665240000
For hoods	HDC 10B DMDQ 2QB N	2559740000

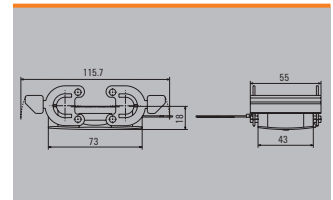

Note: N = Plastic locking lever with stainless steel inlay

Base

Bulkhead housing



Version	Cover	b (mm)	Type	Order No.
Side-locking		29.5	HDC 10B ABU	1205000000
Side-locking		29.5	HDC 10B ABU N	2488580000

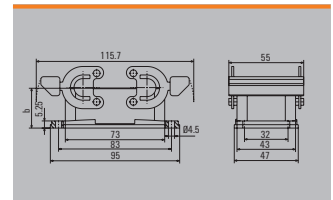

Note: N = Plastic locking lever with stainless steel inlay

Base housing



a	Version	Cover	b (mm)	Type	Order No.
M 20	Side-locking		57	HDC 10B SBU 1M20G N	2560880000
M 20	Side-locking		57	HDC 10B SBU 2M20G	1787640000
M 20	Side-locking		57	HDC 10B SBU 2M20G N	2560890000
M 25	Side-locking		57	HDC 10B SBU 1M25G N	2560900000
M 25	Side-locking		57	HDC 10B SBU 2M25G	1787630000
M 25	Side-locking		57	HDC 10B SBU 2M25G N	2560910000

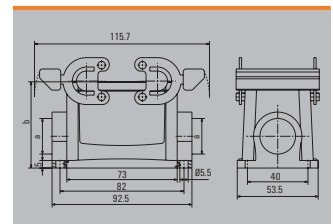

Note: N = Plastic locking lever with stainless steel inlay

Coupling housing



a	Version	Cover	b (mm)	Type	Order No.
M 20	w. thread		54.65	HDC 10B KBU 1M20G	1787720000
M 20	w. thread		54.65	HDC 10B KBU 1M20G N	2559860000

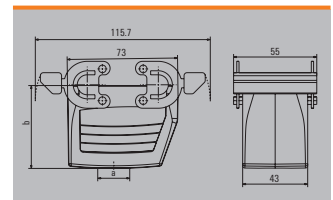

Note: N = Plastic locking lever with stainless steel inlay

Cover



Version	Type	Order No.
For bases	HDC 10B DDDQ 4B0	1665230000

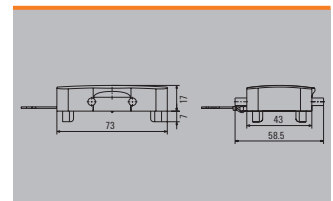

500 V, 16 A, size 6

16 + ⊕

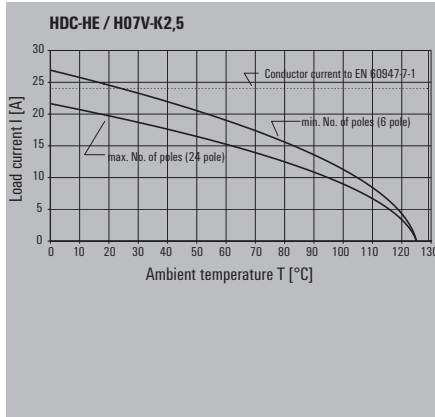
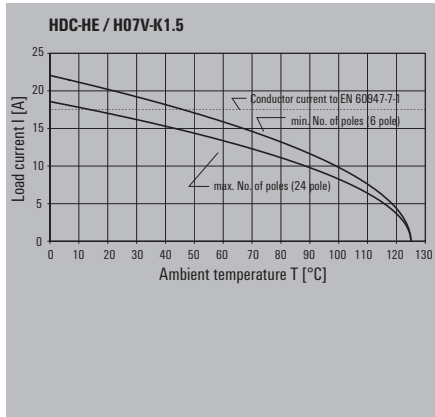

Installation cut-out

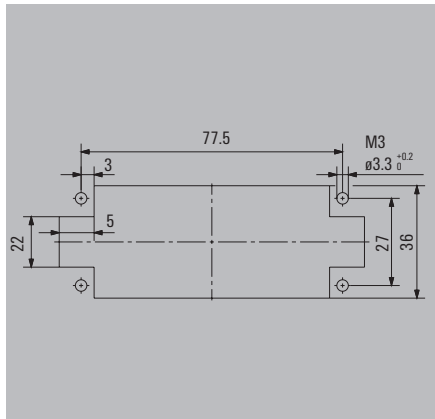

Male

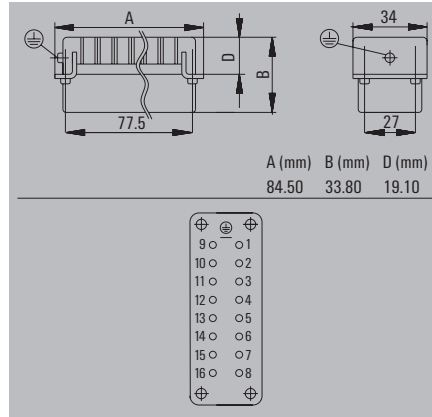

Ordering data

Type of connection	Type	Qty.	Order No.
Tension-clamp conn.	HDC HE 16 MT	1	1745840000
Screw connection	HDC HE 16 MS	1	1207500000
PUSH IN	HDC HE 16 MP	1	1873570000
Crimp connection	HDC HE 16 MC	1	1207900000
SNAP IN	HDC HE 16 MQT	1	2666970000

Accessories

Type	Qty.	Order No.
Crimp contacts, male - gold		
HDC-C-HE-SM0.5AU	100	1651420000
HDC-C-HE-SM0.75-1.00AU	100	1651430000
HDC-C-HE-SM1.5AU	100	1651440000
HDC-C-HE-SM2.5AU	100	1651450000
HDC-C-HE-SM4.0AU	100	1651460000
Crimp contacts, male - silver		
HDC-C-HE-SM0.5AG	100	1200500000
HDC-C-HE-SM0.75-1.00AG	100	1200600000
HDC-C-HE-SM1.5AG	100	1200700000
HDC-C-HE-SM2.5AG	100	1200800000
HDC-C-HE-SM4.0AG	100	1200900000
Tools		
CTX CM 1.6/2.5	1	9018490000
REMOVAL TOOL HE	1	1866750000

Female

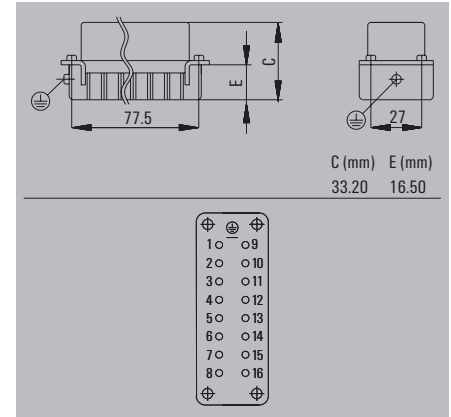

Ordering data

Type of connection	Type	Qty.	Order No.
Tension-clamp conn.	HDC HE 16 FT	1	1745780000
Screw connection	HDC HE 16 FS	1	1207700000
PUSH IN	HDC HE 16 FP	1	1873560000
Crimp connection	HDC HE 16 FC	1	1208000000
SNAP IN	HDC HE 16 FQT	1	2666950000

Accessories

Type	Qty.	Order No.
Crimp contacts, female - gold		
HDC-C-HE-BM0.5AU	100	1651470000
HDC-C-HE-BM0.75-1.00AU	100	1651480000
HDC-C-HE-BM1.5AU	100	1651490000
HDC-C-HE-BM2.5AU	100	1651500000
HDC-C-HE-BM4.0AU	100	1651510000
Crimp contacts, female - silver		
HDC-C-HE-BM0.5AG	100	1201100000
HDC-C-HE-BM0.75-1.00AG	100	1201200000
HDC-C-HE-BM1.5AG	100	1201300000
HDC-C-HE-BM2.5AG	100	1201400000
HDC-C-HE-BM4.0AG	100	1201500000
Tools		
CTX CM 1.6/2.5	1	9018490000
REMOVAL TOOL HE	1	1866750000

Housing selection RockStar® IP65
Size 6



For additional housings, refer to
Chapter D for IP65 / Chapter E for IP65 EMC /
Chapter F for IP68 EMC

Hood

Plug housing, cable entry sideways



a	Version	Cover	b (mm)	Type	Order No.
M 25	w. thread		61	HDC 16B TSBU 1M25G	1788180000
M 25	w. thread		76	HDC 40D TSBU 1M25G	1787010000
M 32	w. thread		76	HDC 40D TSBU 1M32G	1787000000

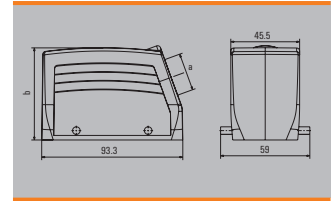

Plug housing, cable entry at top



a	Version	Cover	b (mm)	Type	Order No.
M 25	w. thread		61	HDC 16B TOBU 1M25G	1788210000
M 25	w. thread		76	HDC 40D TOBU 1M25G	1787070000
M 32	w. thread		76	HDC 40D TOBU 1M32G	1787060000

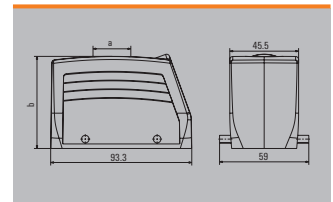

Cover



Version	Type	Order No.
For hoods	HDC 16B DMDQ 2QB	1665270000

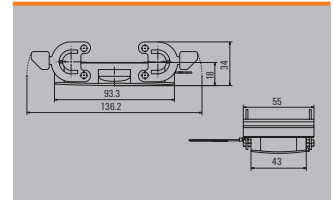

Base

Bulkhead housing



Version	Cover	b (mm)	Type	Order No.
Side-locking		29	HDC 16B ABU	1208600000
Side-locking		29	HDC 16B ABU N	2488590000

Note: N = Plastic locking lever with stainless steel inlay

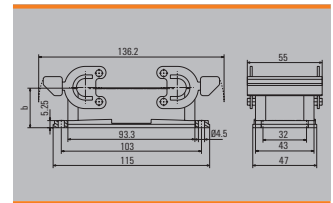

Base housing



a	Version	Cover	b (mm)	Type	Order No.
M 25	Side-locking		64	HDC 16B SBU 1M25G N	2560740000
M 25	Side-locking		64	HDC 16B SBU 2M25G	1788240000
M 25	Side-locking		64	HDC 16B SBU 2M25G N	2560930000
M 25	Side-locking		84	HDC 40D SBU 2M25G	1787120000
PG 21	Side-locking		84	HDC 40D SBU 1M32G N	2561030000
M 32	Side-locking		84	HDC 40D SBU 2M32G	1787110000

Note: N = Plastic locking lever with stainless steel inlay

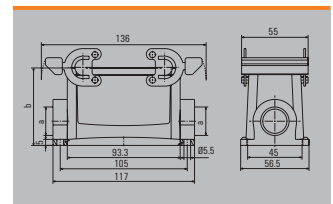

Coupling housing



a	Version	Cover	b (mm)	Type	Order No.
M 25	w. thread		78.6	HDC 40D KBU 1M25G	1787200000
PG 29	w. thread		79	HDC 40D KBU 1M25G N	2559890000
M 32	w. thread		78.6	HDC 40D KBU 1M32G	1787190000
PG 29	w. thread		79	HDC 40D KBU 1M32G N	2559900000
PG 29	w. thread		79	HDC 40D KBU 2M32G N	2545510000

Note: N = Plastic locking lever with stainless steel inlay

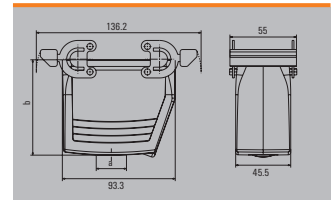

Cover



Version	Type	Order No.
For bases	HDC 16B DDDQ 4B0	1665260000

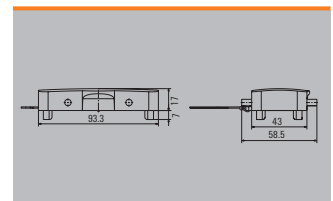

500 V, 16 A, size 8

24 + ⊕

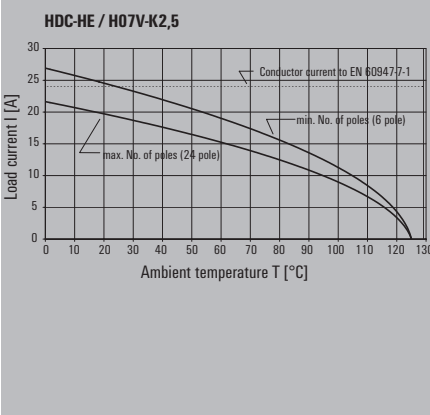
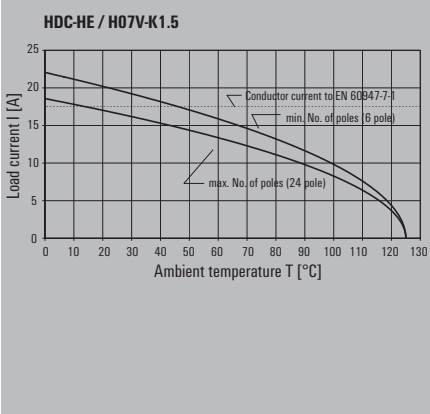

Installation cut-out

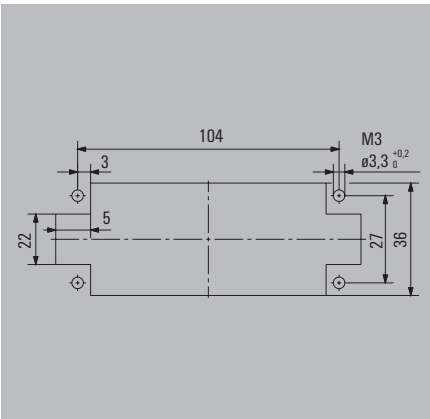

Male

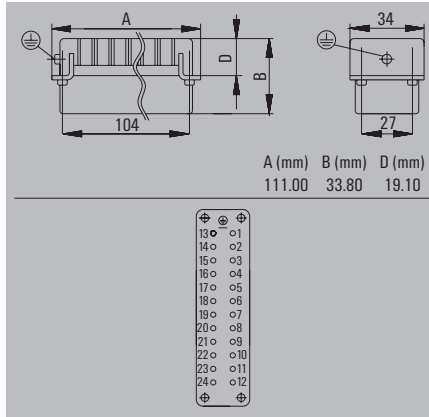

Ordering data

Type of connection	Type	Qty.	Order No.
Tension-clamp conn.	HDC HE 24 MT	1	1745850000
Screw connection	HDC HE 24 MS	1	1211100000
PUSH IN	HDC HE 24 MP	1	1873590000
Crimp connection	HDC HE 24 MC	1	1211500000
SNAP IN	HDC HE 24 MQT	1	2667010000

Accessories

Type	Qty.	Order No.
Crimp contacts, male - gold		
HDC-C-HE-SM0.5AU	100	1651420000
HDC-C-HE-SM0.75-1.00AU	100	1651430000
HDC-C-HE-SM1.5AU	100	1651440000
HDC-C-HE-SM2.5AU	100	1651450000
HDC-C-HE-SM4.0AU	100	1651460000
Crimp contacts, male - silver		
HDC-C-HE-SM0.5AG	100	1200500000
HDC-C-HE-SM0.75-1.00AG	100	1200600000
HDC-C-HE-SM1.5AG	100	1200700000
HDC-C-HE-SM2.5AG	100	1200800000
HDC-C-HE-SM4.0AG	100	1200900000
Tools		
CTX CM 1.6/2.5	1	9018490000
REMOVAL TOOL HE	1	1866750000

Female

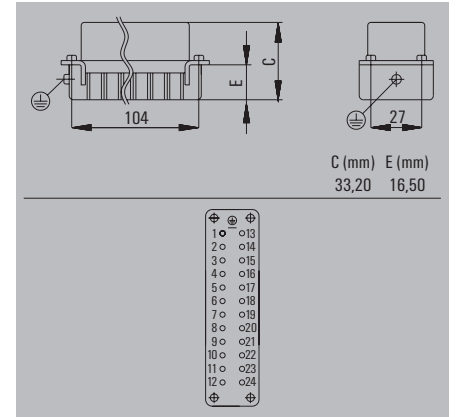

Ordering data

Type of connection	Type	Qty.	Order No.
Tension-clamp conn.	HDC HE 24 FT	1	1745790000
Screw connection	HDC HE 24 FS	1	1211300000
PUSH IN	HDC HE 24 FP	1	1873580000
Crimp connection	HDC HE 24 FC	1	1211600000
SNAP IN	HDC HE 24 FQT	1	2666990000

Accessories

Type	Qty.	Order No.
Crimp contacts, female - gold		
HDC-C-HE-BM0.5AU	100	1651470000
HDC-C-HE-BM0.75-1.00AU	100	1651480000
HDC-C-HE-BM1.5AU	100	1651490000
HDC-C-HE-BM2.5AU	100	1651500000
HDC-C-HE-BM4.0AU	100	1651510000
Crimp contacts, female - silver		
HDC-C-HE-BM0.5AG	100	1201100000
HDC-C-HE-BM0.75-1.00AG	100	1201200000
HDC-C-HE-BM1.5AG	100	1201300000
HDC-C-HE-BM2.5AG	100	1201400000
HDC-C-HE-BM4.0AG	100	1201500000
Tools		
CTX CM 1.6/2.5	1	9018490000
REMOVAL TOOL HE	1	1866750000

Housing selection RockStar® IP65 Size 8



For additional housings, refer to
Chapter D for IP65 / Chapter E for IP65 EMC /
Chapter F for IP68 EMC

Hood

Plug housing, cable entry sideways



a	Version	Cover	b (mm)	Type	Order No.
M 25	w. thread		62.58	HDC 24B TSBU 1M25G	1787760000
M 25	w. thread		76	HDC 64D TSBU 1M25G	1786780000
M 32	w. thread		62.58	HDC 24B TSBU 1M32G	1787750000
M 32	w. thread		76	HDC 64D TSBU 1M32G	1786770000

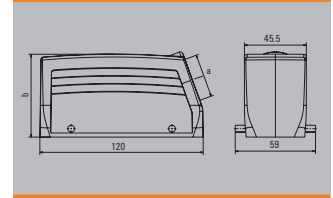

Plug housing, cable entry at top



a	Version	Cover	b (mm)	Type	Order No.
M 25	w. thread		62.58	HDC 24B TOBU 1M25G	1787820000
M 32	w. thread		62.58	HDC 24B TOBU 1M32G	1787810000
M 32	w. thread		76	HDC 64D TOBU 1M32G	1786830000

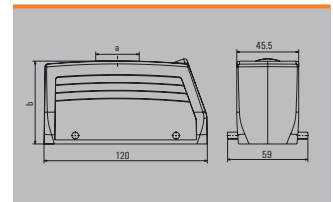

Cover



Version	Type	Order No.
For hoods	HDC 24B DMDQ 2QB	1665640000
For hoods	HDC 24B DMDQ 2QB N	2559760000

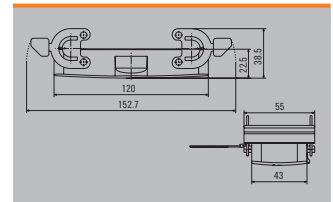

Note Note: N = Plastic locking lever with stainless steel inlay

Base

Bulkhead housing



Version	Cover	b (mm)	Type	Order No.
Side-locking		29.5	HDC 24B ABU	1212400000
Side-locking		29.5	HDC 24B ABU N	2488600000

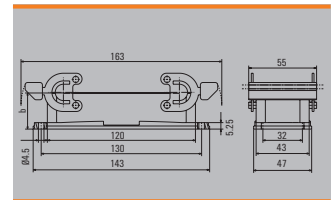

Note Note: N = Plastic locking lever with stainless steel inlay

Base housing



a	Version	Cover	b (mm)	Type	Order No.
M 25	Side-locking		64	HDC 24B SBU 2M25G	1787870000
M 25	Side-locking		64	HDC 24B SBU 2M25G N	2560970000
M 25	Side-locking		84	HDC 64D SBU 2M25G	1786890000
M 32	Side-locking		84	HDC 64D SBU 2M25G N	2561060000
M 32	Side-locking		84	HDC 64D SBU 1M32G N	2561050000
M 32	Side-locking		84	HDC 64D SBU 2M32G	1786880000

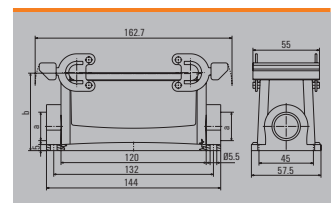

Note Note: N = Plastic locking lever with stainless steel inlay

Coupling housing



a	Version	Cover	b (mm)	Type	Order No.
M 25	w. thread		65	HDC 24B KBU 1M25G	1787920000
M 25	w. thread		65	HDC 24B KBU 1M25G N	2559870000
M 32	w. thread		65	HDC 24B KBU 2M32G N	2559880000
M 32	w. thread		79	HDC 64D KBU 1M32G	1786960000
M 32	w. thread		79	HDC 64D KBU 1M32G N	2559910000

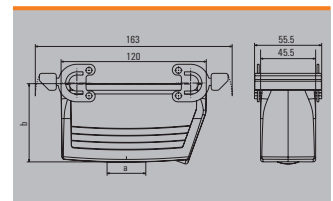

Note Note: N = Plastic locking lever with stainless steel inlay

Cover



Version	Type	Order No.
For bases	HDC 24B DDDQ 4B0	1665630000

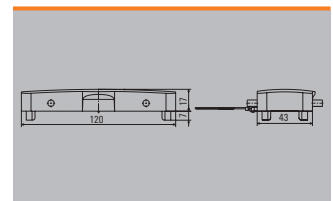

500 V, 16 A, size 10

32 + ⊕

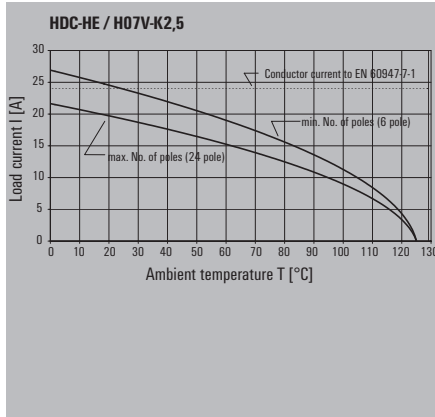
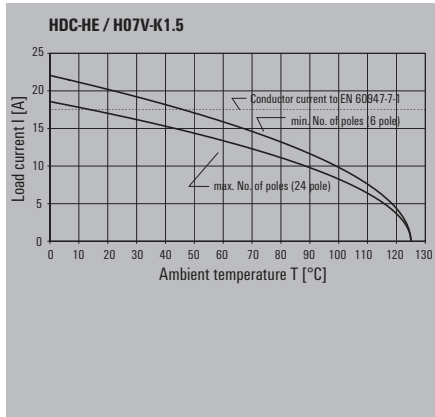

Installation cut-out

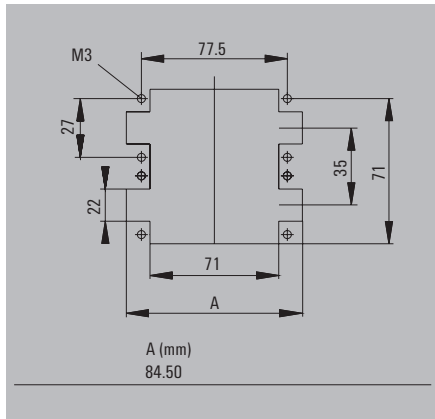

Male

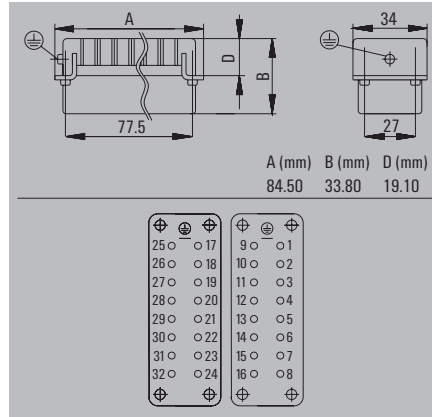

Ordering data

Type of connection	Type	Qty.	Order No.
Tension-clamp conn.	HDC HE 16 MT	1	1745840000
Screw connection	HDC HE 16 MS	1	1207500000
PUSH IN	HDC HE 16 MP	1	1873570000
Crimp connection	HDC HE 16 MC	1	1207900000
SNAP IN	HDC HE 16 MQT	1	2666970000
Tension-clamp conn.	HDC HE 16 MT 17-32	1	1745860000
Screw connection	HDC HE 16 MS 17-32	1	1215700000
PUSH IN	HDC HE 16 MP 17-32	1	1875800000
Crimp connection	HDC HE 16 MC 17-32	1	1216500000
SNAP IN	HDC HE 16 MQT 17-32	1	2666980000

Accessories

Type	Qty.	Order No.
Crimp contacts, male - gold		
HDC-C-HE-SM0.5AU	100	1651420000
HDC-C-HE-SM0.75-1.00AU	100	1651430000
HDC-C-HE-SM1.5AU	100	1651440000
HDC-C-HE-SM2.5AU	100	1651450000
HDC-C-HE-SM4.0AU	100	1651460000
Crimp contacts, male - silver		
HDC-C-HE-SM0.5AG	100	1200500000
HDC-C-HE-SM0.75-1.00AG	100	1200600000
HDC-C-HE-SM1.5AG	100	1200700000
HDC-C-HE-SM2.5AG	100	1200800000
HDC-C-HE-SM4.0AG	100	1200900000
Tools		
CTX CM 1.6/2.5	1	9018490000
REMOVAL TOOL HE	1	1866750000

Female

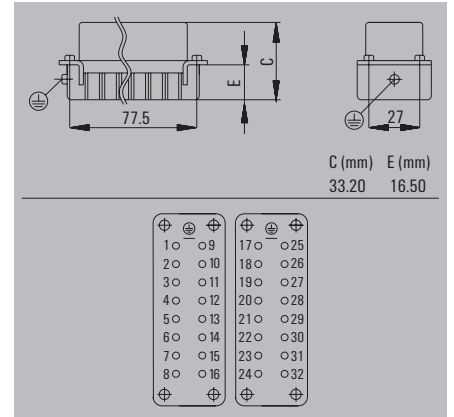
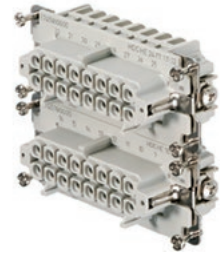

Ordering data

Type of connection	Type	Qty.	Order No.
Tension-clamp conn.	HDC HE 16 FT	1	1745780000
Screw connection	HDC HE 16 FS	1	1207700000
PUSH IN	HDC HE 16 FP	1	1873560000
Crimp connection	HDC HE 16 FC	1	1208000000
SNAP IN	HDC HE 16 FQT	1	2666950000
Tension-clamp conn.	HDC HE 16 FT 17-32	1	1745800000
Screw connection	HDC HE 16 FS 17-32	1	1216100000
PUSH IN	HDC HE 16 FP 17-32	1	1875740000
Crimp connection	HDC HE 16 FC 17-32	1	1216700000
SNAP IN	HDC HE 16 FQT 17-32	1	2666960000

Accessories

Type	Qty.	Order No.
Crimp contacts, female - gold		
HDC-C-HE-BM0.5AU	100	1651470000
HDC-C-HE-BM0.75-1.00AU	100	1651480000
HDC-C-HE-BM1.5AU	100	1651490000
HDC-C-HE-BM2.5AU	100	1651500000
HDC-C-HE-BM4.0AU	100	1651510000
Crimp contacts, female - silver		
HDC-C-HE-BM0.5AG	100	1201100000
HDC-C-HE-BM0.75-1.00AG	100	1201200000
HDC-C-HE-BM1.5AG	100	1201300000
HDC-C-HE-BM2.5AG	100	1201400000
HDC-C-HE-BM4.0AG	100	1201500000
Tools		
CTX CM 1.6/2.5	1	9018490000
REMOVAL TOOL HE	1	1866750000

Housing selection RockStar® IP65
Size 10



For additional housings, refer to chapter D for IP65

Hood

Plug housing, cable entry sideways



a	Version	Cover	b (mm)	Type	Order No.
M 32	w. thread		79	HDC 32B TSLU 1M32G	1788420000

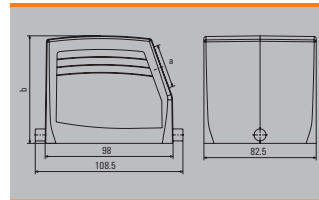

Base

Bulkhead housing



Version	Cover	b (mm)	Type	Order No.
End-locking		38	HDC 32B ALU	1219500000
End-locking	with cover	55	HDC 32B ADLU	1219800000

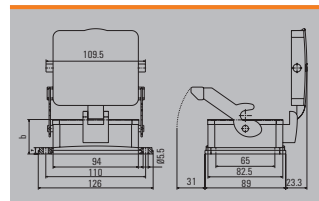

Base housing



a	Version	Cover	b (mm)	Type	Order No.
M 32	End-locking		79	HDC 32B SLU 2M32G	1788470000
M 32	End-locking	with cover	96	HDC 32B SDLU 2M32G	1788490000

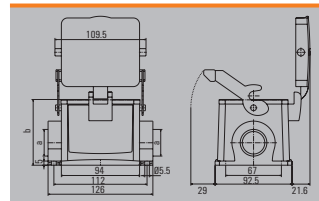

Coupling housing



a	Version	Cover	b (mm)	Type	Order No.
M 32	w. thread		83	HDC 32B KLU 1M32G	1788500000

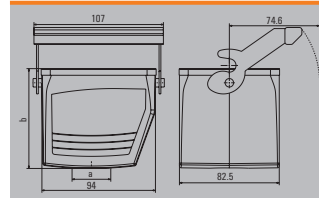

500 V, 16 A, size 12

48 + ⊕

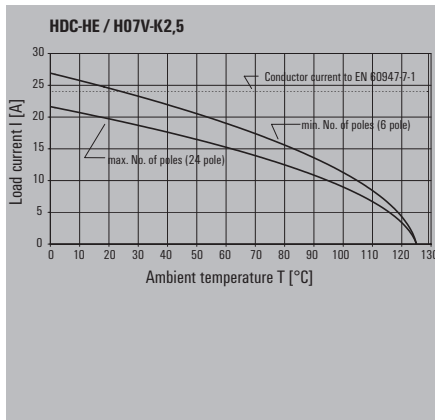
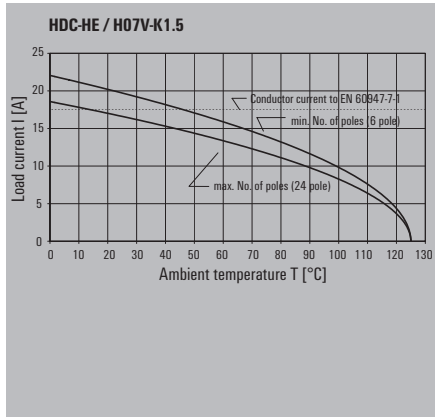

Installation cut-out

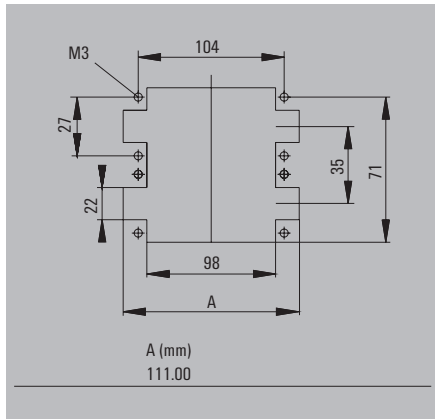

Male

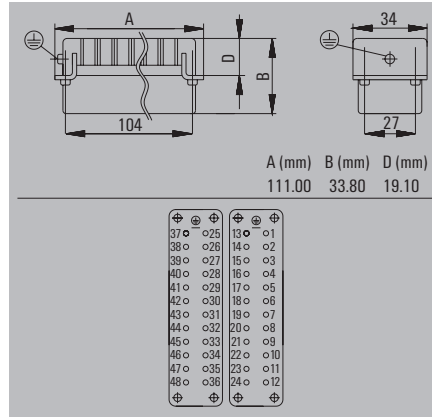

Female

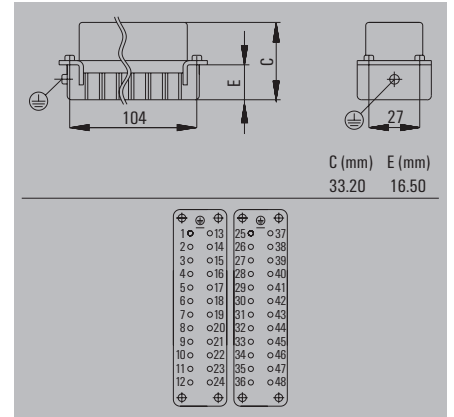
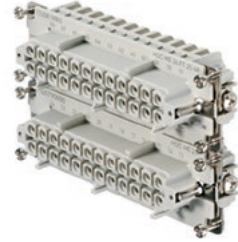

Ordering data

Type of connection	Type	Qty.	Order No.
Tension-clamp conn.	HDC HE 24 MT	1	1745850000
Screw connection	HDC HE 24 MS	1	1211100000
PUSH IN	HDC HE 24 MP	1	1873590000
Crimp connection	HDC HE 24 MC	1	1211500000
SNAP IN	HDC HE 24 MQT	1	2667010000
Tension-clamp conn.	HDC HE 24 MT 25-48	1	1745870000
Screw connection	HDC HE 24 MS 25-48	1	1220800000
PUSH IN	HDC HE 24 MP 25-48	1	1875890000
Crimp connection	HDC HE 24 MC 25-48	1	1226400000
SNAP IN	HDC HE 24 MQT 25 - 48	1	2667020000

Ordering data

Type of connection	Type	Qty.	Order No.
Tension-clamp conn.	HDC HE 24 FT	1	1745790000
Screw connection	HDC HE 24 FS	1	1211300000
PUSH IN	HDC HE 24 FP	1	1873580000
Crimp connection	HDC HE 24 FC	1	1211600000
SNAP IN	HDC HE 24 FQT	1	2666990000
Tension-clamp conn.	HDC HE 24 FT 25-48	1	1745810000
Screw connection	HDC HE 24 FS 25-48	1	1221200000
PUSH IN	HDC HE 24 FP 25-48	1	1875850000
Crimp connection	HDC HE 24 FC 25-48	1	1226600000
SNAP IN	HDC HE 24 FQT 25 - 48	1	2667000000

Accessories

Type	Qty.	Order No.
Crimp contacts, male - gold		
HDC-C-HE-SM0.5AU	100	1651420000
HDC-C-HE-SM0.75-1.00AU	100	1651430000
HDC-C-HE-SM1.5AU	100	1651440000
HDC-C-HE-SM2.5AU	100	1651450000
HDC-C-HE-SM4.0AU	100	1651460000
Crimp contacts, male - silver		
HDC-C-HE-SM0.5AG	100	1200500000
HDC-C-HE-SM0.75-1.00AG	100	1200600000
HDC-C-HE-SM1.5AG	100	1200700000
HDC-C-HE-SM2.5AG	100	1200800000
HDC-C-HE-SM4.0AG	100	1200900000
Tools		
CTX CM 1.6/2.5	1	9018490000
REMOVAL TOOL HE	1	1866750000

Accessories

Type	Qty.	Order No.
Crimp contacts, female - gold		
HDC-C-HE-BM0.5AU	100	1651470000
HDC-C-HE-BM0.75-1.00AU	100	1651480000
HDC-C-HE-BM1.5AU	100	1651490000
HDC-C-HE-BM2.5AU	100	1651500000
HDC-C-HE-BM4.0AU	100	1651510000
Crimp contacts, female - silver		
HDC-C-HE-BM0.5AG	100	1201100000
HDC-C-HE-BM0.75-1.00AG	100	1201200000
HDC-C-HE-BM1.5AG	100	1201300000
HDC-C-HE-BM2.5AG	100	1201400000
HDC-C-HE-BM4.0AG	100	1201500000
Tools		
CTX CM 1.6/2.5	1	9018490000
REMOVAL TOOL HE	1	1866750000

Housing selection RockStar® IP65 Size 12



For additional housings, refer to
chapter D for IP65

Hood

Plug housing, cable entry sideways



a	Version	Cover	b (mm)	Type	Order No.
M 32	w. thread		94	HDC 48B TSLU 1M32G	1788320000
M 40	w. thread		94	HDC 48B TSLU 1M40G	1788310000
M 50	w. thread		94	HDC 48B TSLU 1M50G	1788300000

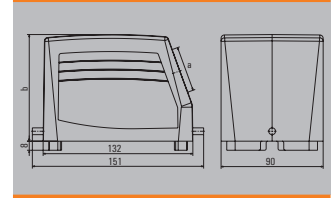

Plug housing, cable entry at top



a	Version	Cover	b (mm)	Type	Order No.
M 32	w. thread		94	HDC 48B TOLU 1M32G	1788350000
M 50	w. thread		94	HDC 48B TOLU 1M50G	1788330000

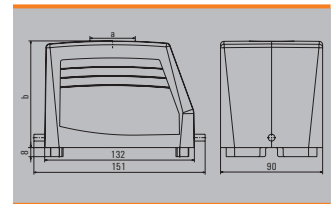

Base

Bulkhead housing



Version	Cover	b (mm)	Type	Order No.
End-locking	with cover	62	HDC 48B ADLU	1222900000

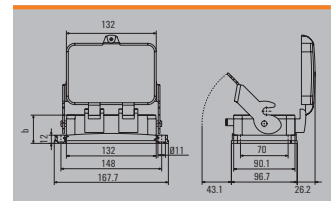

Base housing



a	Version	Cover	b (mm)	Type	Order No.
M 32	End-locking		100	HDC 48B SLU 2M32G	1788370000
M 32	End-locking	with cover	120	HDC 48B SDLU 2M32G	1788390000
M 40	End-locking		100	HDC 48B SLU 2M40G	1788360000

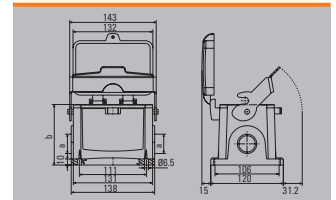

HEE series

Powerful and convenient: HE/HEE inserts enable efficient signal transmission of up to 64 contacts at maximum 16 A and 500 V

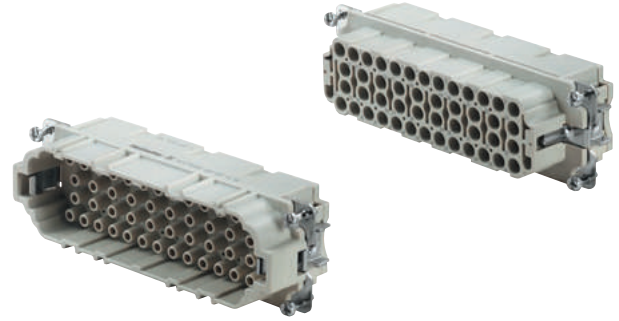











Technical data

Standards/approvals	
Standards	DIN EN 61984 DIN EN 60664-1
Approvals	UL/CSA
Inserts	
No. of poles	10, 18, 32, 46, 64 (+ PE)
Rated voltage	500 V
Rated voltage to UL/CSA	600 V
Rated current	16 A
Rated impulse withstand voltage	6 kV
Pollution severity	3 (630 V / 6 kV / 2)
Insulation resistance	$\geq 10^{10} \Omega$
Material	Glass-fibre reinforced PC (in UL list and approved for railway applications)
Temperature range	-40 °C to +125 °C
Flammability to UL 94	V - 0
Mechanical service life	
- Plugging cycles Ag-Surface	≥ 500
- Plugging cycles Au-Surface	≥ 500
Contact resistance	
Crimp connection	$\leq 2 \text{ m}\Omega$
Contacts/Material	
Contacts	Copper alloy
Surface	Passivated silver, or gold-plated
Crimp connection	
- Flexible conductor connection	0.5 - 4 mm ² (AWG 20 - 12)
- Stripping length	7.5 mm
PE connection	
- Clamping range	0.5 - 4 mm ²
- solid/stranded	0.5 - 4 mm ² / 0.5 - 4 mm ²
- flexible/flexible with wire end ferrule, DIN 46228 pt. 1	0.5 - 4 mm ² / 0.5 - 4 mm ²
- AWG conductor	AWG 20 - 12
- Stripping length	10 mm
- Clamping torque	1.2 - 1.5 Nm
- Blade dimensions	SD 0.8 x 4 mm or PZ1

Note:

When used properly and as designated, the listed connectors may not be connected or disconnected if there is a live voltage or load!

Overview

		Size	Rated voltage	Rated current	No. of poles	Tension clamp connection	TOP connection	Screw conn. with wire guard spring	Crimp connection	PUSH IN connection	Page
		3	500 V	16 A	10 + ⊕				•		B.34
		4	500 V	16 A	18 + ⊕				•		B.36
		6	500 V	16 A	32 + ⊕				•		B.42
		8	500 V	16 A	46 + ⊕				•		B.40
		10	500 V	16 A	64 + ⊕				•		B.42

500 V, 16 A, size 3

10 + ⊕

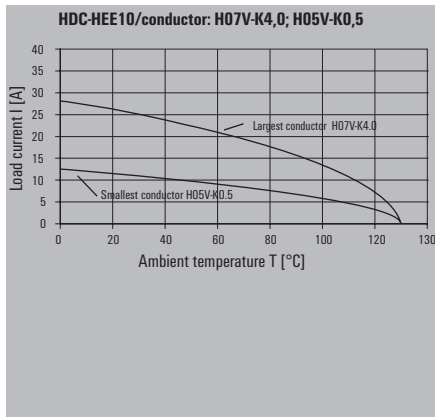

Installation cut-out

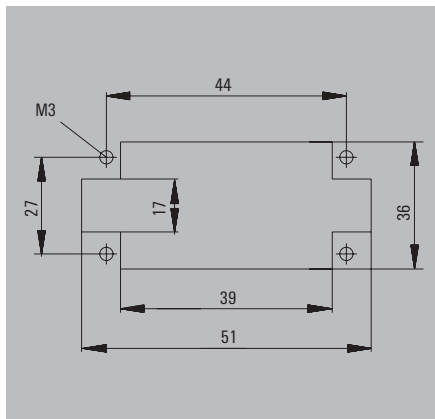

Male

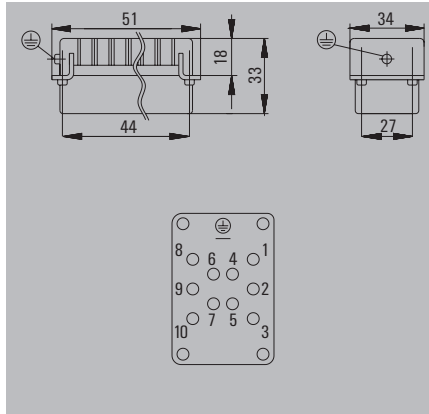

Ordering data

Type of connection	Type	Qty.	Order No.
Crimp connection	HDC HEE 10 MC	1	1826830000

Accessories

Type	Qty.	Order No.
Crimp contacts, male - gold		
HDC-C-HE-SM0.5AU	100	1651420000
HDC-C-HE-SM0.75-1.00AU	100	1651430000
HDC-C-HE-SM1.5AU	100	1651440000
HDC-C-HE-SM2.5AU	100	1651450000
HDC-C-HE-SM4.0AU	100	1651460000
Crimp contacts, male - silver		
HDC-C-HE-SM0.5AG	100	1200500000
HDC-C-HE-SM0.75-1.00AG	100	1200600000
HDC-C-HE-SM1.5AG	100	1200700000
HDC-C-HE-SM2.5AG	100	1200800000
HDC-C-HE-SM4.0AG	100	1200900000
Tools		
CTX CM 1.6/2.5	1	9018490000
REMOVAL TOOL HE	1	1866750000

Female

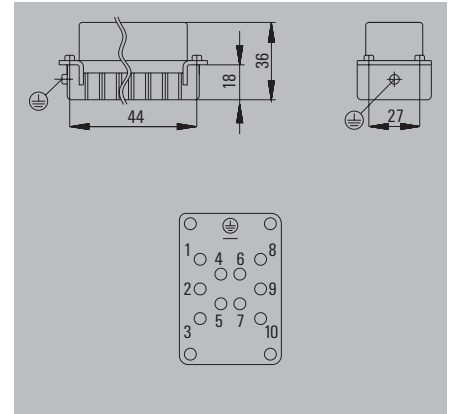

Ordering data

Type of connection	Type	Qty.	Order No.
Crimp connection	HDC HEE 10 FC	1	1826840000

Accessories

Type	Qty.	Order No.
Crimp contacts, female - gold		
HDC-C-HE-BM0.5AU	100	1651470000
HDC-C-HE-BM0.75-1.00AU	100	1651480000
HDC-C-HE-BM1.5AU	100	1651490000
HDC-C-HE-BM2.5AU	100	1651500000
HDC-C-HE-BM4.0AU	100	1651510000
Crimp contacts, female - silver		
HDC-C-HE-BM0.5AG	100	1201100000
HDC-C-HE-BM0.75-1.00AG	100	1201200000
HDC-C-HE-BM1.5AG	100	1201300000
HDC-C-HE-BM2.5AG	100	1201400000
HDC-C-HE-BM4.0AG	100	1201500000
Tools		
CTX CM 1.6/2.5	1	9018490000
REMOVAL TOOL HE	1	1866750000

Housing selection RockStar® IP65
Size 3

 For additional housings, refer to
Chapter D for IP65 / Chapter E for IP65 EMC /
Chapter F for IP68 EMC

Hood

Plug housing, cable entry sideways



a	Version	Cover	b (mm)	Type	Order No.
M 20	w. thread		52	HDC 06B TSLU 1M20G	1788100000
M 25	w. thread		52	HDC 06B TSLU 1M25G	1788090000
M 25	w. thread		72	HDC 16D TSLU 1M25G	1787480000

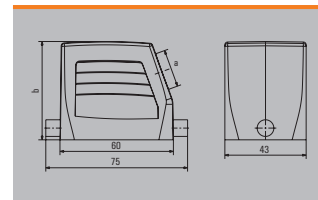

Plug housing, cable entry at top



a	Version	Cover	b (mm)	Type	Order No.
M 20	w. thread		52	HDC 06B TOLU 1M20G	1788120000
M 25	w. thread		52	HDC 06B TOLU 1M25G	1788110000
M 25	w. thread		72	HDC 16D TOLU 1M25G	1787500000
M 32	w. thread		72	HDC 16D TOLU 1M32G	1787490000

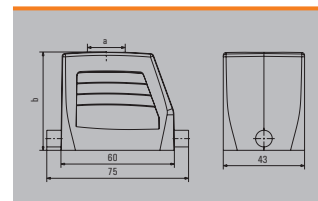

Cover



Version	Type	Order No.
For hoods	HDC 06B DMDL 1LB	1665210000
For hoods	HDC 06B DMDL 1LB N	2559730000

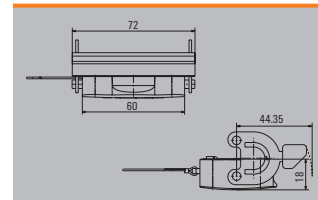

Note Note: N = Plastic locking lever with stainless steel inlay

Base

Bulkhead housing



Version	Cover	b (mm)	Type	Order No.
End-locking	without cover	29.3	HDC 06B ALU	1202100000
End-locking	without cover	29.3	HDC 06B ALU N	2488560000
End-locking	with cover	29.3	HDC 06B ADLU	1202500000
End-locking	with cover	29.3	HDC 06B ADLU N	2559320000

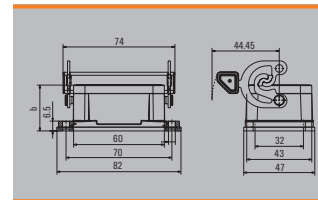

Note Note: N = Plastic locking lever with stainless steel inlay

Base housing



a	Version	Cover	b (mm)	Type	Order No.
M 20	End-locking		54	HDC 06B SLU 1M20G N	2637080000
M 20	End-locking	with cover	54	HDC 06B SDLU 1M20G N	2560720000
M 20	End-locking	with cover	54	HDC 06B SLU 2M20G	1788140000
M 20	End-locking	with cover	54	HDC 06B SDLU 2M20G	1788170000
M 25	End-locking		54	HDC 06B SLU 2M25G	1788130000
M 25	End-locking	without cover	54	HDC 06B SLU 2M25G N	2560860000
M 25	End-locking	with cover	54	HDC 06B SDLU 2M25G	1788160000
M 25	End-locking	with cover	54	HDC 06B SDLU 2M25G N	2560830000

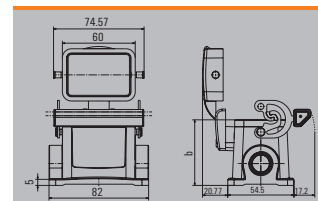

Note Note: N = Plastic locking lever with stainless steel inlay

Cover



Version	Type	Order No.
For bases	HDC 06B DDDL 2B0	1665200000

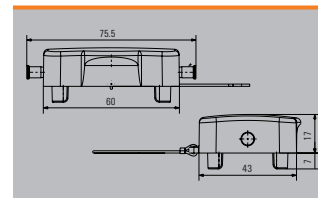

500V, 16 A, size 4

18 + ⊕

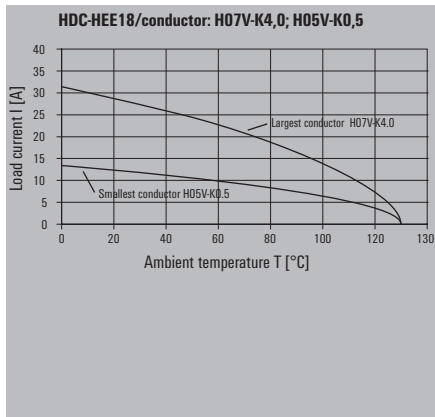

Installation cut-out

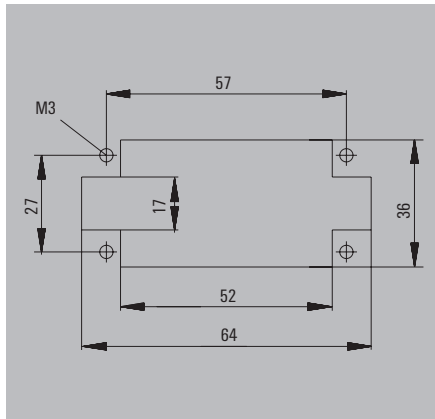

Male

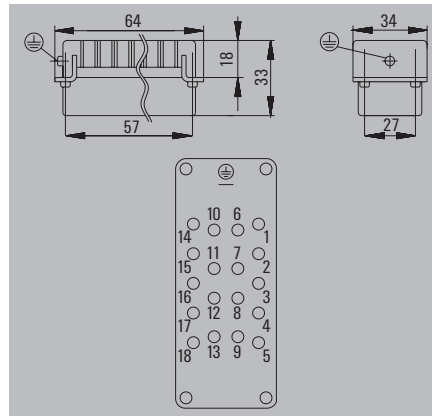
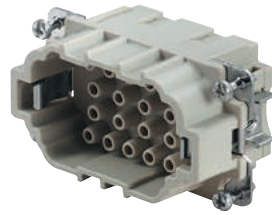

Ordering data

Type of connection	Type	Qty.	Order No.
Crimp connection	HDC HEE 18 MC	1	1826810000

Accessories

Type	Qty.	Order No.
Crimp contacts, male - gold		
HDC-C-HE-SM0.5AU	100	1651420000
HDC-C-HE-SM0.75-1.00AU	100	1651430000
HDC-C-HE-SM1.5AU	100	1651440000
HDC-C-HE-SM2.5AU	100	1651450000
HDC-C-HE-SM4.0AU	100	1651460000
Crimp contacts, male - silver		
HDC-C-HE-SM0.5AG	100	1200500000
HDC-C-HE-SM0.75-1.00AG	100	1200600000
HDC-C-HE-SM1.5AG	100	1200700000
HDC-C-HE-SM2.5AG	100	1200800000
HDC-C-HE-SM4.0AG	100	1200900000
Tools		
CTX CM 1.6/2.5	1	9018490000
REMOVAL TOOL HE	1	1866750000

Female

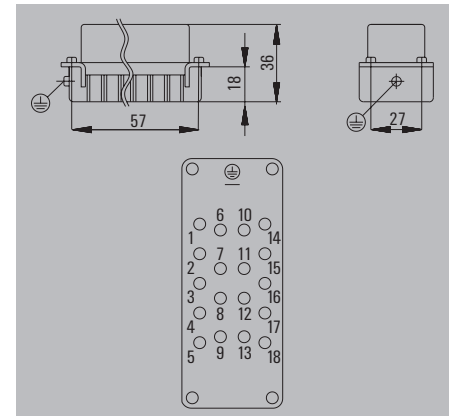
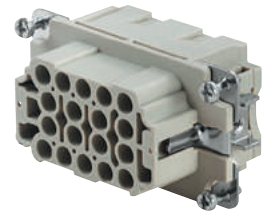

Ordering data

Type of connection	Type	Qty.	Order No.
Crimp connection	HDC HEE 18 FC	1	1826820000

Accessories

Type	Qty.	Order No.
Crimp contacts, female - gold		
HDC-C-HE-BM0.5AU	100	1651470000
HDC-C-HE-BM0.75-1.00AU	100	1651480000
HDC-C-HE-BM1.5AU	100	1651490000
HDC-C-HE-BM2.5AU	100	1651500000
HDC-C-HE-BM4.0AU	100	1651510000
Crimp contacts, female - silver		
HDC-C-HE-BM0.5AG	100	1201100000
HDC-C-HE-BM0.75-1.00AG	100	1201200000
HDC-C-HE-BM1.5AG	100	1201300000
HDC-C-HE-BM2.5AG	100	1201400000
HDC-C-HE-BM4.0AG	100	1201500000
Tools		
CTX CM 1.6/2.5	1	9018490000
REMOVAL TOOL HE	1	1866750000

Housing selection RockStar® IP65
Size 4

 For additional housings, refer to
Chapter D for IP65 / Chapter E for IP65 EMC /
Chapter F for IP68 EMC

Hood

Plug housing, cable entry sideways



a	Version	Cover	b (mm)	Type	Order No.
M 20	w. thread		52	HDC 10B TSBU 1M20G	1787560000
M 25	w. thread		52	HDC 10B TSBU 1M25G	1787550000
M 25	w. thread		72	HDC 24D TSBU 1M25G	1787240000
M 32	w. thread		72	HDC 24D TSBU 1M32G	1787230000

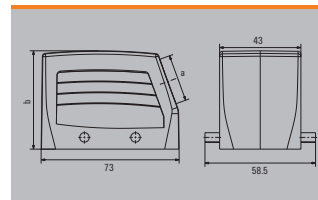

Plug housing, cable entry at top



a	Version	Cover	b (mm)	Type	Order No.
M 20	w. thread		52	HDC 10B TOBU 1M20G	1787600000
M 25	w. thread		52	HDC 10B TOBU 1M25G	1787590000
M 25	w. thread		72	HDC 24D TOBU 1M25G	1787300000
M 32	w. thread		72	HDC 24D TOBU 1M32G	1787290000

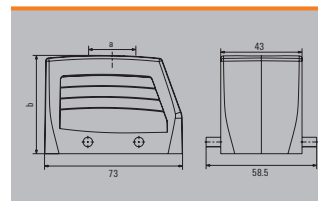

Cover



Version	Type	Order No.
For hoods	HDC 10B DMDQ 2QB	1665240000
For hoods	HDC 10B DMDQ 2QB N	2559740000

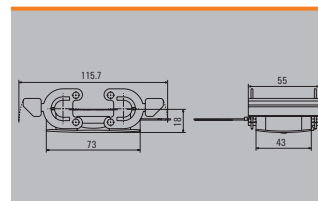

Note: N = Plastic locking lever with stainless steel inlay

Base

Bulkhead housing



Version	Cover	b (mm)	Type	Order No.
Side-locking		29.5	HDC 10B ABU	1205000000
Side-locking		29.5	HDC 10B ABU N	2488580000

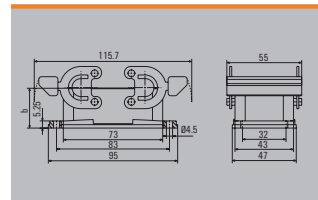

Note: N = Plastic locking lever with stainless steel inlay

Base housing



a	Version	Cover	b (mm)	Type	Order No.
M 20	Side-locking		57	HDC 10B SBU 1M20G N	2560880000
M 20	Side-locking		57	HDC 10B SBU 2M20G	1787640000
M 20	Side-locking		57	HDC 10B SBU 2M20G N	2560890000
M 25	Side-locking		57	HDC 10B SBU 1M25G N	2560900000
M 25	Side-locking		57	HDC 10B SBU 2M25G	1787630000
M 25	Side-locking		57	HDC 10B SBU 2M25G N	2560910000

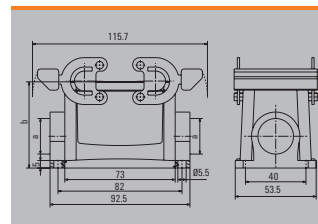

Note: N = Plastic locking lever with stainless steel inlay

Coupling housing



a	Version	Cover	b (mm)	Type	Order No.
M 20	w. thread		54.65	HDC 10B KBU 1M20G	1787720000
M 20	w. thread		54.65	HDC 10B KBU 1M20G N	2559860000

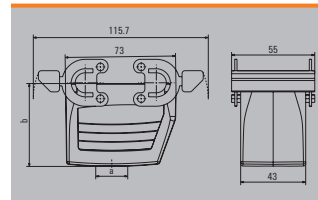

Note: N = Plastic locking lever with stainless steel inlay

Cover



Version	Type	Order No.
For bases	HDC 10B DDDQ 4B0	1665230000

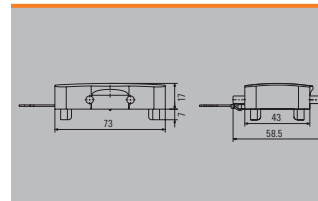

500 V, 16 A, size 6

32 + ⊕

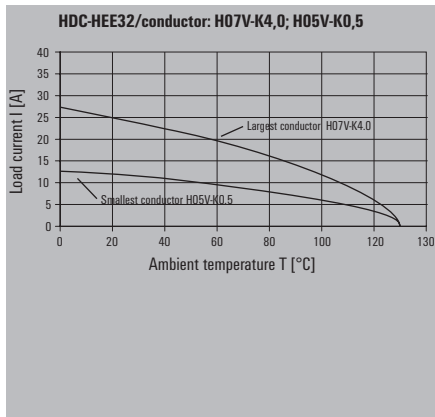

Installation cut-out

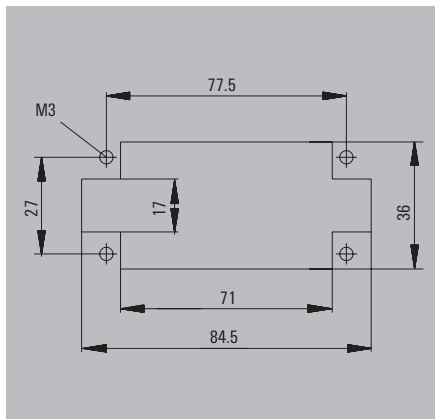

Male

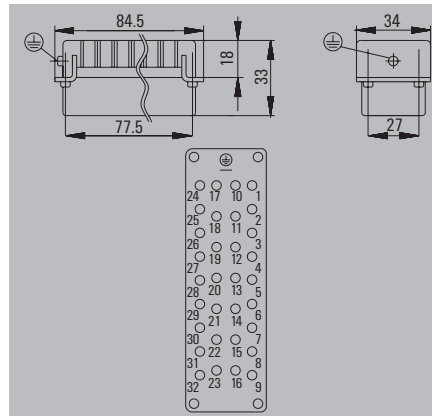
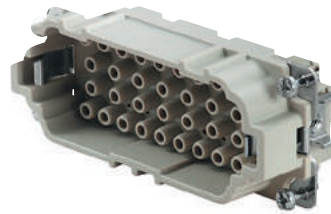

Ordering data

Type of connection	Type	Qty.	Order No.
Crimp connection	HDC HEE 32 MC	1	1826790000

Accessories

Type	Qty.	Order No.
Crimp contacts, male - gold		
HDC-C-HE-SM0.5AU	100	1651420000
HDC-C-HE-SM0.75-1.00AU	100	1651430000
HDC-C-HE-SM1.5AU	100	1651440000
HDC-C-HE-SM2.5AU	100	1651450000
HDC-C-HE-SM4.0AU	100	1651460000
Crimp contacts, male - silver		
HDC-C-HE-SM0.5AG	100	1200500000
HDC-C-HE-SM0.75-1.00AG	100	1200600000
HDC-C-HE-SM1.5AG	100	1200700000
HDC-C-HE-SM2.5AG	100	1200800000
HDC-C-HE-SM4.0AG	100	1200900000
Tools		
CTX CM 1.6/2.5	1	9018490000
REMOVAL TOOL HE	1	1866750000

Female

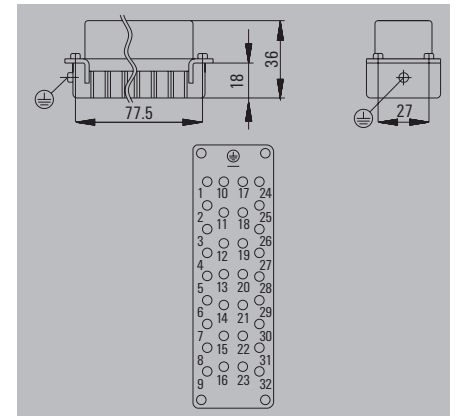

Ordering data

Type of connection	Type	Qty.	Order No.
Crimp connection	HDC HEE 32 FC	1	1826800000

Accessories

Type	Qty.	Order No.
Crimp contacts, female - gold		
HDC-C-HE-BM0.5AU	100	1651470000
HDC-C-HE-BM0.75-1.00AU	100	1651480000
HDC-C-HE-BM1.5AU	100	1651490000
HDC-C-HE-BM2.5AU	100	1651500000
HDC-C-HE-BM4.0AU	100	1651510000
Crimp contacts, female - silver		
HDC-C-HE-BM0.5AG	100	1201100000
HDC-C-HE-BM0.75-1.00AG	100	1201200000
HDC-C-HE-BM1.5AG	100	1201300000
HDC-C-HE-BM2.5AG	100	1201400000
HDC-C-HE-BM4.0AG	100	1201500000
Tools		
CTX CM 1.6/2.5	1	9018490000
REMOVAL TOOL HE	1	1866750000

Housing selection RockStar® IP65
Size 6

 For additional housings, refer to
Chapter D for IP65 / Chapter E for IP65 EMC /
Chapter F for IP68 EMC

Hood

Plug housing, cable entry sideways



a	Version	Cover	b (mm)	Type	Order No.
M 25	w. thread		61	HDC 16B TSBU 1M25G	1788180000
M 25	w. thread		76	HDC 40D TSBU 1M25G	1787010000
M 32	w. thread		76	HDC 40D TSBU 1M32G	1787000000

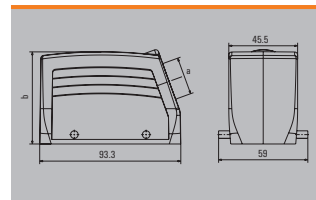

Plug housing, cable entry at top



a	Version	Cover	b (mm)	Type	Order No.
M 25	w. thread		61	HDC 16B TOBU 1M25G	1788210000
M 25	w. thread		76	HDC 40D TOBU 1M25G	1787070000
M 32	w. thread		76	HDC 40D TOBU 1M32G	1787060000

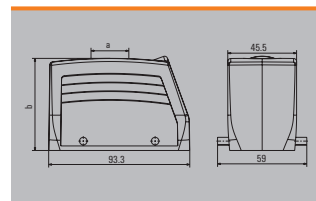

Cover



Version	Type	Order No.
For hoods	HDC 16B DMDQ 2QB	1665270000

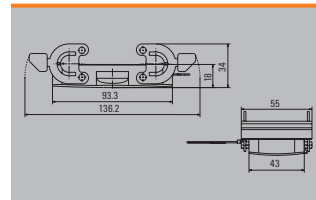

Base

Bulkhead housing



Version	Cover	b (mm)	Type	Order No.
Side-locking		29	HDC 16B ABU	1208600000
Side-locking		29	HDC 16B ABU N	2488590000

Note: N = Plastic locking lever with stainless steel inlay

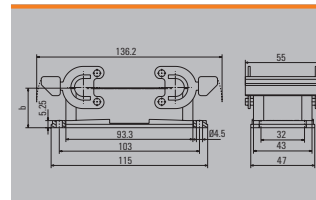

Base housing



a	Version	Cover	b (mm)	Type	Order No.
M 25	Side-locking		64	HDC 16B SBU 1M25G N	2560740000
M 25	Side-locking		64	HDC 16B SBU 2M25G	1788240000
M 25	Side-locking		64	HDC 16B SBU 2M25G N	2560930000
M 25	Side-locking		84	HDC 40D SBU 2M25G	1787120000
PG 21	Side-locking		84	HDC 40D SBU 1M32G N	2561030000
M 32	Side-locking		84	HDC 40D SBU 2M32G	1787110000

Note: N = Plastic locking lever with stainless steel inlay

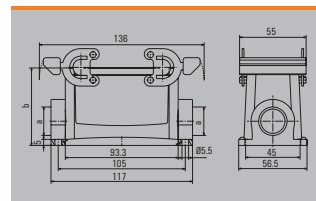

Coupling housing



a	Version	Cover	b (mm)	Type	Order No.
M 25	w. thread		78.6	HDC 40D KBU 1M25G	1787200000
PG 29	w. thread		79	HDC 40D KBU 1M25G N	2559890000
M 32	w. thread		78.6	HDC 40D KBU 1M32G	1787190000
PG 29	w. thread		79	HDC 40D KBU 1M32G N	2559900000
PG 29	w. thread		79	HDC 40D KBU 2M32G N	2545510000

Note: N = Plastic locking lever with stainless steel inlay

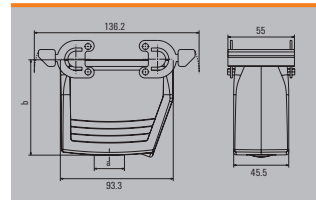

Cover



Version	Type	Order No.
For bases	HDC 16B DDDQ 480	1665260000

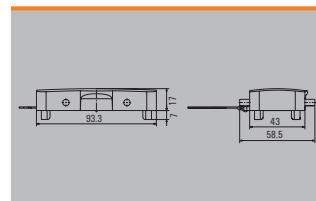

500 V, 16 A, size 8

46 + ⊕

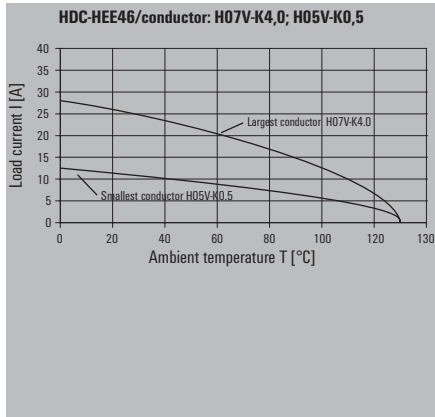

Installation cut-out

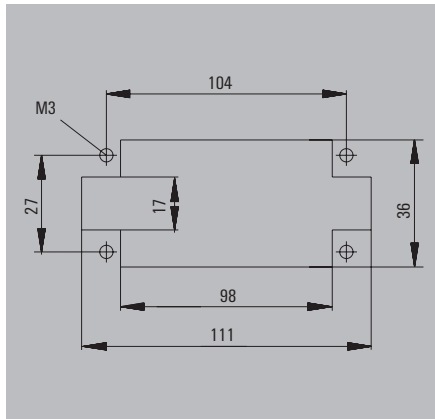

Male

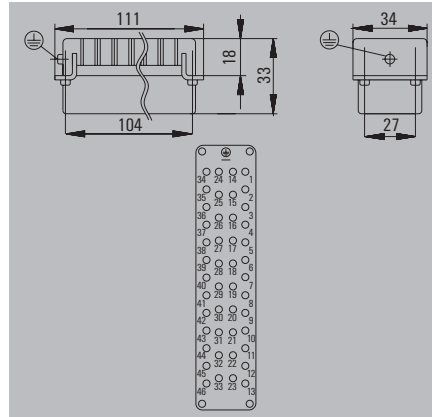

Ordering data

Type of connection	Type	Qty.	Order No.
Crimp connection	HDC HEE 46 MC	1	1826770000

Accessories

Type	Qty.	Order No.
Crimp contacts, male - gold		
HDC-C-HE-SM0.5AU	100	1651420000
HDC-C-HE-SM0.75-1.00AU	100	1651430000
HDC-C-HE-SM1.5AU	100	1651440000
HDC-C-HE-SM2.5AU	100	1651450000
HDC-C-HE-SM4.0AU	100	1651460000
Crimp contacts, male - silver		
HDC-C-HE-SM0.5AG	100	1200500000
HDC-C-HE-SM0.75-1.00AG	100	1200600000
HDC-C-HE-SM1.5AG	100	1200700000
HDC-C-HE-SM2.5AG	100	1200800000
HDC-C-HE-SM4.0AG	100	1200900000
Tools		
CTX CM 1.6/2.5	1	9018490000
REMOVAL TOOL HE	1	1866750000

Female

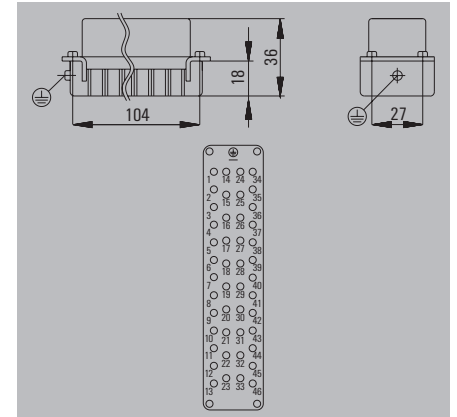

Ordering data

Type of connection	Type	Qty.	Order No.
Crimp connection	HDC HEE 46 FC	1	1826780000

Accessories

Type	Qty.	Order No.
Crimp contacts, female - gold		
HDC-C-HE-BM0.5AU	100	1651470000
HDC-C-HE-BM0.75-1.00AU	100	1651480000
HDC-C-HE-BM1.5AU	100	1651490000
HDC-C-HE-BM2.5AU	100	1651500000
HDC-C-HE-BM4.0AU	100	1651510000
Crimp contacts, female - silver		
HDC-C-HE-BM0.5AG	100	1201100000
HDC-C-HE-BM0.75-1.00AG	100	1201200000
HDC-C-HE-BM1.5AG	100	1201300000
HDC-C-HE-BM2.5AG	100	1201400000
HDC-C-HE-BM4.0AG	100	1201500000
Tools		
CTX CM 1.6/2.5	1	9018490000
REMOVAL TOOL HE	1	1866750000

Housing selection RockStar® IP65
Size 8



For additional housings, refer to
Chapter D for IP65 / Chapter E for IP65 EMC /
Chapter F for IP68 EMC

Hood

Plug housing, cable entry sideways



a	Version	Cover	b (mm)	Type	Order No.
M 25	w. thread		62.58	HDC 24B TSBU 1M25G	1787760000
M 25	w. thread		76	HDC 64D TSBU 1M25G	1786780000
M 32	w. thread		62.58	HDC 24B TSBU 1M32G	1787750000
M 32	w. thread		76	HDC 64D TSBU 1M32G	1786770000

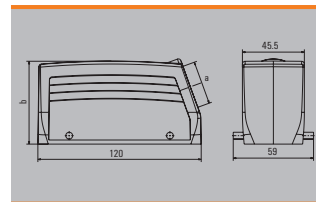

Plug housing, cable entry at top



a	Version	Cover	b (mm)	Type	Order No.
M 25	w. thread		62.58	HDC 24B TOBU 1M25G	1787820000
M 32	w. thread		62.58	HDC 24B TOBU 1M32G	1787810000
M 32	w. thread		76	HDC 64D TOBU 1M32G	1786830000

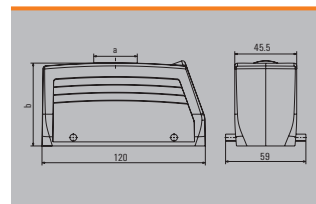

Cover



Version	Type	Order No.
For hoods	HDC 24B DMDQ 2QB	1665640000
For hoods	HDC 24B DMDQ 2QB N	2559760000

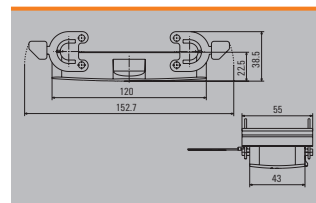

Note: N = Plastic locking lever with stainless steel inlay

Base

Bulkhead housing



Version	Cover	b (mm)	Type	Order No.
Side-locking		29.5	HDC 24B ABU	1212400000
Side-locking		29.5	HDC 24B ABU N	2488600000

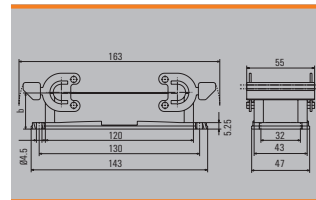

Note: N = Plastic locking lever with stainless steel inlay

Base housing



a	Version	Cover	b (mm)	Type	Order No.
M 25	Side-locking		64	HDC 24B SBU 2M25G	1787870000
M 25	Side-locking		64	HDC 24B SBU 2M25G N	2560970000
M 25	Side-locking		84	HDC 64D SBU 2M25G	1786890000
M 32	Side-locking		84	HDC 64D SBU 2M25G N	2561060000
M 32	Side-locking		84	HDC 64D SBU 1M32G N	2561050000
M 32	Side-locking		84	HDC 64D SBU 2M32G	1786880000

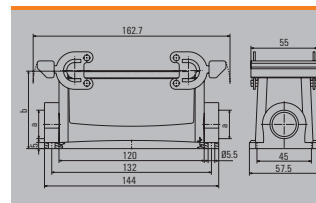

Note: N = Plastic locking lever with stainless steel inlay

Coupling housing



a	Version	Cover	b (mm)	Type	Order No.
M 25	w. thread		65	HDC 24B KBU 1M25G	1787920000
M 25	w. thread		65	HDC 24B KBU 1M25G N	2559870000
M 32	w. thread		65	HDC 24B KBU 2M32G N	2559880000
M 32	w. thread		79	HDC 64D KBU 1M32G	1786960000
M 32	w. thread		79	HDC 64D KBU 1M32G N	2559910000

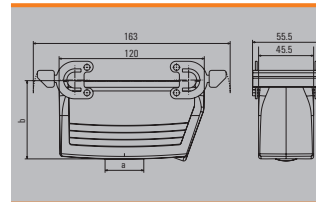

Note: N = Plastic locking lever with stainless steel inlay

Cover



Version	Type	Order No.
For bases	HDC 24B DDDQ 4B0	1665630000

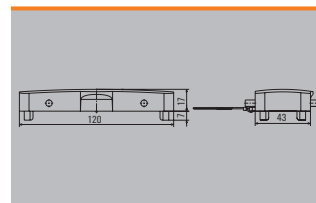

500 V, 16 A, size 10

64 + ⊕

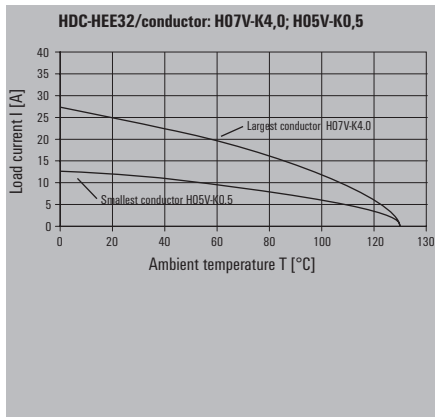

Male

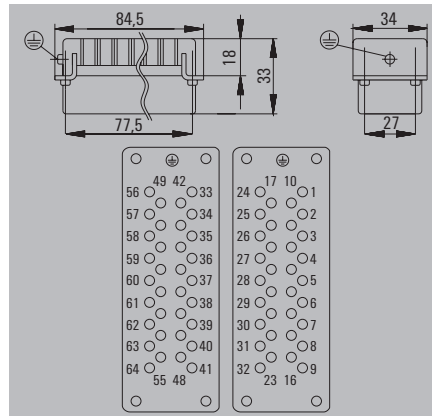

Ordering data

Type of connection	Type	Qty.	Order No.
Crimp connection	HDC HEE 32 MC	1	1826790000
Crimp connection	HDC HEE 32 MC 33-64	1	1018950000

Female

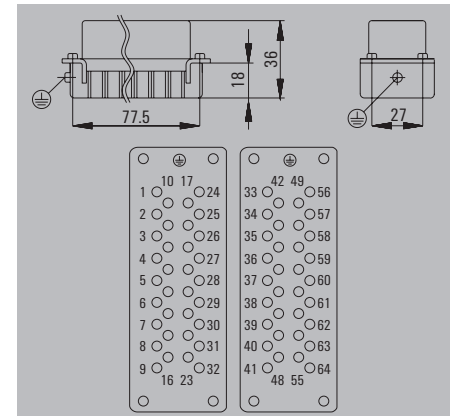

Ordering data

Type of connection	Type	Qty.	Order No.
Crimp connection	HDC HEE 32 FC	1	1826800000
Crimp connection	HDC HEE 32 FC 33-64	1	1018960000

Installation cut-out

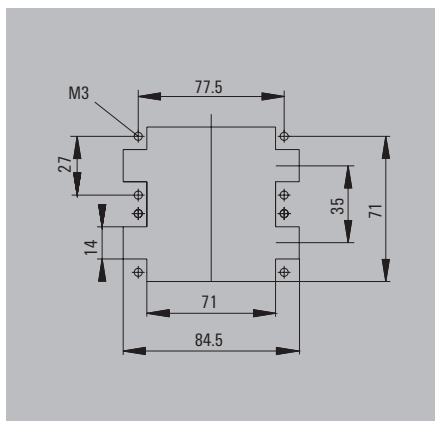

Accessories

Type	Qty.	Order No.
Crimp contacts, male - gold		
HDC-C-HE-SM0.5AU	100	1651420000
HDC-C-HE-SM0.75-1.00AU	100	1651430000
HDC-C-HE-SM1.5AU	100	1651440000
HDC-C-HE-SM2.5AU	100	1651450000
HDC-C-HE-SM4.0AU	100	1651460000
Crimp contacts, male - silver		
HDC-C-HE-SM0.5AG	100	1200500000
HDC-C-HE-SM0.75-1.00AG	100	1200600000
HDC-C-HE-SM1.5AG	100	1200700000
HDC-C-HE-SM2.5AG	100	1200800000
HDC-C-HE-SM4.0AG	100	1200900000
Tools		
CTX CM 1.6/2.5	1	9018490000
REMOVAL TOOL HE	1	1866750000

Accessories

Type	Qty.	Order No.
Crimp contacts, female - gold		
HDC-C-HE-BM0.5AU	100	1651470000
HDC-C-HE-BM0.75-1.00AU	100	1651480000
HDC-C-HE-BM1.5AU	100	1651490000
HDC-C-HE-BM2.5AU	100	1651500000
HDC-C-HE-BM4.0AU	100	1651510000
Crimp contacts, female - silver		
HDC-C-HE-BM0.5AG	100	1201100000
HDC-C-HE-BM0.75-1.00AG	100	1201200000
HDC-C-HE-BM1.5AG	100	1201300000
HDC-C-HE-BM2.5AG	100	1201400000
HDC-C-HE-BM4.0AG	100	1201500000
Tools		
CTX CM 1.6/2.5	1	9018490000
REMOVAL TOOL HE	1	1866750000

Housing selection RockStar® IP65
Size 10



For additional housings, refer to chapter D for IP65

Hood

Plug housing, cable entry sideways



a	Version	Cover	b (mm)	Type	Order No.
M 32	w. thread		79	HDC 32B TSLU 1M32G	1788420000

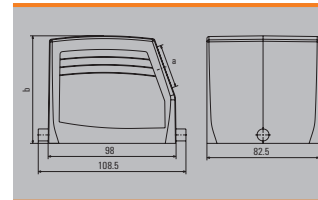

Base

Bulkhead housing



Version	Cover	b (mm)	Type	Order No.
End-locking		38	HDC 32B ALU	1219500000
End-locking	with cover	55	HDC 32B ADLU	1219800000

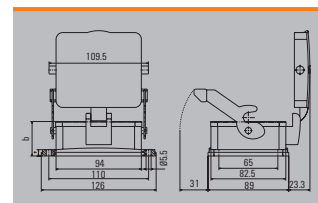

Base housing



a	Version	Cover	b (mm)	Type	Order No.
M 32	End-locking		79	HDC 32B SLU 2M32G	1788470000
M 32	End-locking	with cover	96	HDC 32B SDLU 2M32G	1788490000

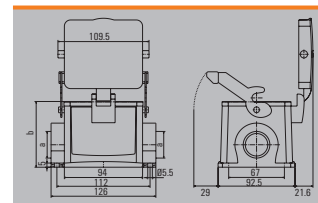

Coupling housing



a	Version	Cover	b (mm)	Type	Order No.
M 32	w. thread		83	HDC 32B KLU 1M32G	1788500000

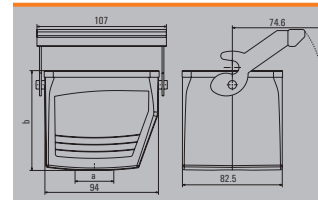

HEEE series

HEEE inserts combine high currents up to 16A with a very high packing density. They are available as 40 and 64 pole units. They can be mounted in size 6 and 8 housings. These space-saving contact inserts are thus a solution when high-pole cables with high currents and voltages up to 500V are used.





Technical data

Standards/approvals	
Standards	DIN EN 61984 DIN EN 60664-1
Approvals	UL/CSA
Inserts	
No. of poles	40, 64 (+PE)
Rated voltage	500 V
Rated voltage to UL/CSA	600 V
Rated current	16 A
Rated impulse withstand voltage	6 kV
Pollution severity	3 (630 V / 6 kV / 2)
Insulation resistance	$\geq 10^{10} \Omega$
Material	Glass-fibre reinforced PC (in UL list and approved for railway applications)
Temperature range	-40 °C to +125 °C
Flammability to UL 94	V - 0
Mechanical service life	
- Plugging cycles Ag-Surface	≥ 500
- Plugging cycles Au-Surface	≥ 500
Contact resistance	
Crimp connection	$\leq 2 \text{ m}\Omega$
Contacts/Material	
Contacts	Copper alloy
Surface	Passivated silver, or gold-plated
Crimp connection	
- Flexible conductor connection	0.5 - 4 mm ² (AWG 20 - 12)
- Stripping length	7.5 mm
PE connection	
- Clamping range	0.5 - 4 mm ²
- solid/stranded	0.5 - 4 mm ² / 0.5 - 4 mm ²
- flexible/flexible with wire end ferrule, DIN 46228 pt. 1	0.5 - 4 mm ² / 0.5 - 4 mm ²
- AWG conductor	AWG 20 - 12
- Stripping length	10 mm
- Clamping torque	1.2 - 1.5 Nm
- Blade dimensions	SD 0.8 x 4 mm or PZ1

Note:

When used properly and as designated, the listed connectors may not be connected or disconnected if there is a live voltage or load!

Overview

	Size	Rated voltage	Rated current	No. of poles	Tension clamp connection	TOP connection	Screw conn. with wire guard spring	Crimp connection	PUSH IN connection	Page
	6	500 V	16 A	40 + ⊕				•		B.46
	8	500 V	16 A	64 + ⊕				•		B.48

500 V, 16 A, size 6

40 + ⊕

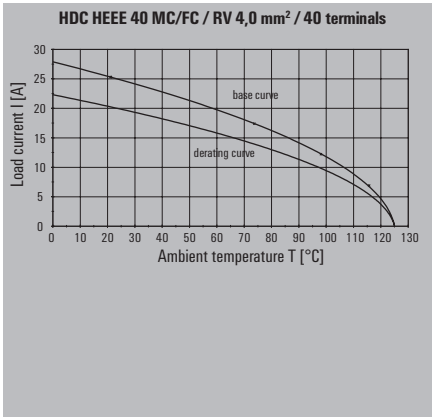

Installation cut-out

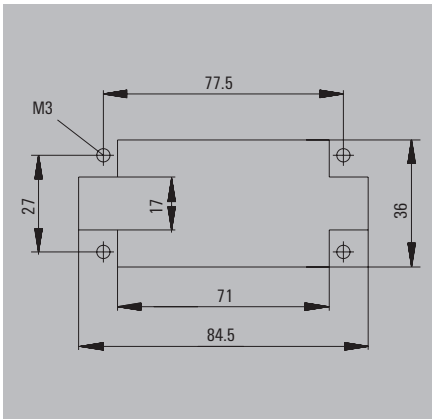

Male

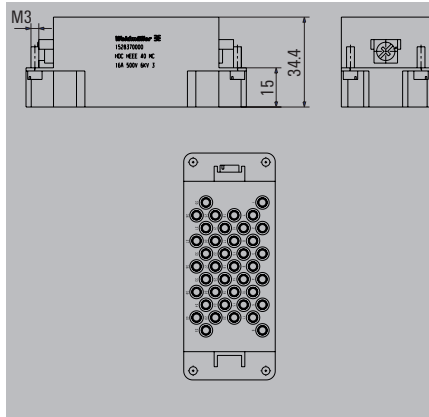

Ordering data

Type of connection	Type	Qty.	Order No.
Crimp connection	HDC HEEE 40 MC	1	1528370000

Accessories

Type	Qty.	Order No.
Crimp contacts, male - gold		
HDC-C-HE-SM0.5AU	100	1651420000
HDC-C-HE-SM0.75-1.00AU	100	1651430000
HDC-C-HE-SM1.5AU	100	1651440000
HDC-C-HE-SM2.5AU	100	1651450000
HDC-C-HE-SM4.0AU	100	1651460000
Crimp contacts, male - silver		
HDC-C-HE-SM0.5AG	100	1200500000
HDC-C-HE-SM0.75-1.00AG	100	1200600000
HDC-C-HE-SM1.5AG	100	1200700000
HDC-C-HE-SM2.5AG	100	1200800000
HDC-C-HE-SM4.0AG	100	1200900000
Tools		
CTX CM 1.6/2.5	1	9018490000
REMOVAL TOOL HE	1	1866750000

Female

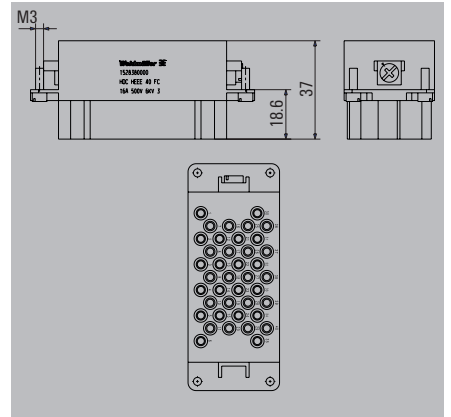

Ordering data

Type of connection	Type	Qty.	Order No.
Crimp connection	HDC HEEE 40 FC	1	1528380000

Accessories

Type	Qty.	Order No.
Crimp contacts, female - gold		
HDC-C-HE-BM0.5AU	100	1651470000
HDC-C-HE-BM0.75-1.00AU	100	1651480000
HDC-C-HE-BM1.5AU	100	1651490000
HDC-C-HE-BM2.5AU	100	1651500000
HDC-C-HE-BM4.0AU	100	1651510000
Crimp contacts, female - silver		
HDC-C-HE-BM0.5AG	100	1201100000
HDC-C-HE-BM0.75-1.00AG	100	1201200000
HDC-C-HE-BM1.5AG	100	1201300000
HDC-C-HE-BM2.5AG	100	1201400000
HDC-C-HE-BM4.0AG	100	1201500000
Tools		
CTX CM 1.6/2.5	1	9018490000
REMOVAL TOOL HE	1	1866750000

Housing selection RockStar® IP65
Size 6

 For additional housings, refer to
Chapter D for IP65 / Chapter E for IP65 EMC /
Chapter F for IP68 EMC

Hood

Plug housing, cable entry sideways



a	Version	Cover	b (mm)	Type	Order No.
M 25	w. thread		61	HDC 16B TSBU 1M25G	1788180000
M 25	w. thread		76	HDC 40D TSBU 1M25G	1787010000
M 32	w. thread		76	HDC 40D TSBU 1M32G	1787000000

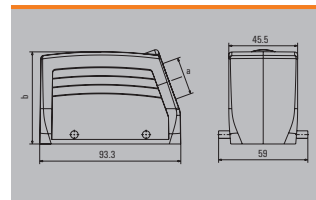

Plug housing, cable entry at top



a	Version	Cover	b (mm)	Type	Order No.
M 25	w. thread		61	HDC 16B TOBU 1M25G	1788210000
M 25	w. thread		76	HDC 40D TOBU 1M25G	1787070000
M 32	w. thread		76	HDC 40D TOBU 1M32G	1787060000

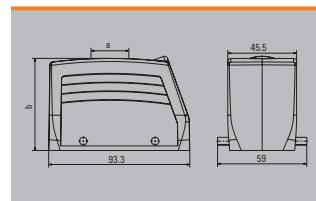

Cover



Version	Type	Order No.
For hoods	HDC 16B DMDQ 2QB	1665270000

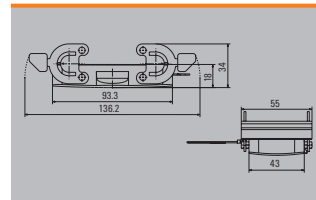

Base

Bulkhead housing



Version	Cover	b (mm)	Type	Order No.
Side-locking		29	HDC 16B ABU	1208600000
Side-locking		29	HDC 16B ABU N	2488590000

Note: N = Plastic locking lever with stainless steel inlay

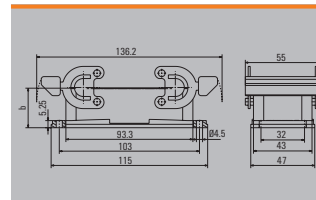

Base housing



a	Version	Cover	b (mm)	Type	Order No.
M 25	Side-locking		64	HDC 16B SBU 1M25G N	2560740000
M 25	Side-locking		64	HDC 16B SBU 2M25G	1788240000
M 25	Side-locking		64	HDC 16B SBU 2M25G N	2560930000
M 25	Side-locking		84	HDC 40D SBU 2M25G	1787120000
PG 21	Side-locking		84	HDC 40D SBU 1M32G N	2561030000
M 32	Side-locking		84	HDC 40D SBU 2M32G	1787110000

Note: N = Plastic locking lever with stainless steel inlay

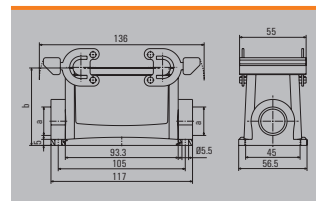

Coupling housing



a	Version	Cover	b (mm)	Type	Order No.
M 25	w. thread		78.6	HDC 40D KBU 1M25G	1787200000
PG 29	w. thread		79	HDC 40D KBU 1M25G N	2559890000
M 32	w. thread		78.6	HDC 40D KBU 1M32G	1787190000
PG 29	w. thread		79	HDC 40D KBU 1M32G N	2559900000
PG 29	w. thread		79	HDC 40D KBU 2M32G N	2545510000

Note: N = Plastic locking lever with stainless steel inlay

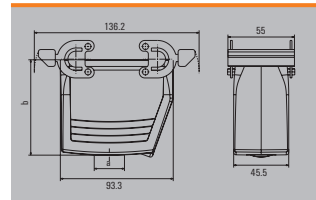

Cover



Version	Type	Order No.
For bases	HDC 16B DDDQ 480	1665260000

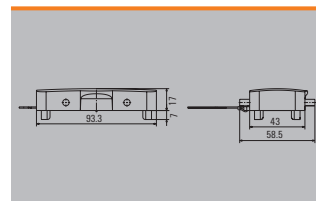

500 V, 16 A, size 8

64 + ⊕

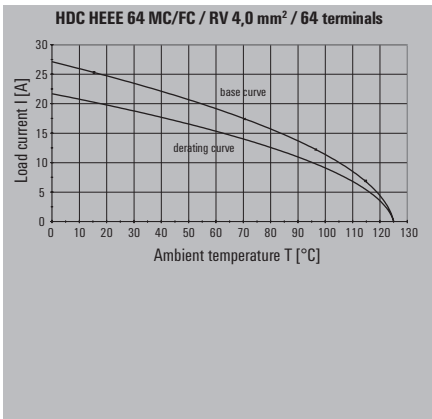

Installation cut-out

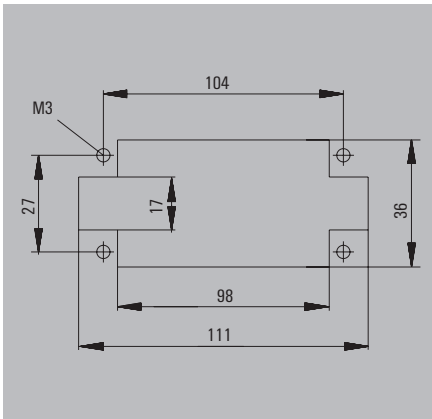

Male

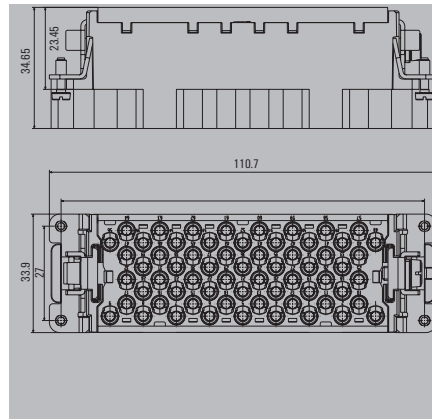

Ordering data

Type of connection	Type	Qty.	Order No.
Crimp connection	HDC HEEE 64 MC	1	2729580000

Accessories

Type	Qty.	Order No.
Crimp contacts, male - gold		
HDC-C-HE-SM0.5AU	100	1651420000
HDC-C-HE-SM0.75-1.00AU	100	1651430000
HDC-C-HE-SM1.5AU	100	1651440000
HDC-C-HE-SM2.5AU	100	1651450000
HDC-C-HE-SM4.0AU	100	1651460000
Crimp contacts, male - silver		
HDC-C-HE-SM0.5AG	100	1200500000
HDC-C-HE-SM0.75-1.00AG	100	1200600000
HDC-C-HE-SM1.5AG	100	1200700000
HDC-C-HE-SM2.5AG	100	1200800000
HDC-C-HE-SM4.0AG	100	1200900000
Tools		
CTX CM 1.6/2.5	1	9018490000
REMOVAL TOOL HE	1	1866750000

Female

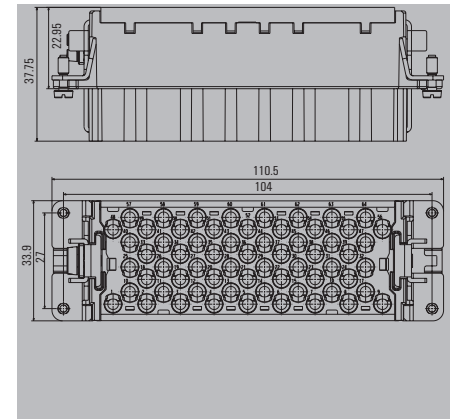

Ordering data

Type of connection	Type	Qty.	Order No.
Crimp connection	HDC HEEE 64 FC	1	2729590000

Accessories

Type	Qty.	Order No.
Crimp contacts, female - gold		
HDC-C-HE-BM0.5AU	100	1651470000
HDC-C-HE-BM0.75-1.00AU	100	1651480000
HDC-C-HE-BM1.5AU	100	1651490000
HDC-C-HE-BM2.5AU	100	1651500000
HDC-C-HE-BM4.0AU	100	1651510000
Crimp contacts, female - silver		
HDC-C-HE-BM0.5AG	100	1201100000
HDC-C-HE-BM0.75-1.00AG	100	1201200000
HDC-C-HE-BM1.5AG	100	1201300000
HDC-C-HE-BM2.5AG	100	1201400000
HDC-C-HE-BM4.0AG	100	1201500000
Tools		
CTX CM 1.6/2.5	1	9018490000
REMOVAL TOOL HE	1	1866750000

Housing selection RockStar® IP65
Size 8

 For additional housings, refer to
Chapter D for IP65 / Chapter E for IP65 EMC /
Chapter F for IP68 EMC

Hood

Plug housing, cable entry sideways



a	Version	Cover	b (mm)	Type	Order No.
M 25	w. thread		62.58	HDC 24B TSBU 1M25G	1787760000
M 25	w. thread		76	HDC 64D TSBU 1M25G	1786780000
M 32	w. thread		62.58	HDC 24B TSBU 1M32G	1787750000
M 32	w. thread		76	HDC 64D TSBU 1M32G	1786770000

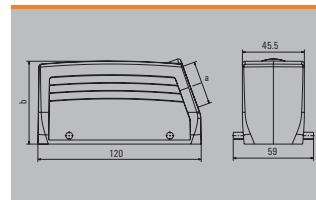

Plug housing, cable entry at top



a	Version	Cover	b (mm)	Type	Order No.
M 25	w. thread		62.58	HDC 24B TOBU 1M25G	1787820000
M 32	w. thread		62.58	HDC 24B TOBU 1M32G	1787810000
M 32	w. thread		76	HDC 64D TOBU 1M32G	1786830000

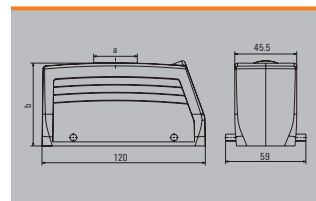

Cover



Version	Type	Order No.
For hoods	HDC 24B DMDQ 2QB	1665640000
For hoods	HDC 24B DMDQ 2QB N	2559760000

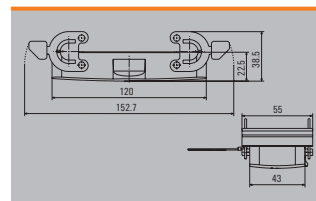

Note: N = Plastic locking lever with stainless steel inlay

Base

Bulkhead housing



Version	Cover	b (mm)	Type	Order No.
Side-locking		29.5	HDC 24B ABU	1212400000
Side-locking		29.5	HDC 24B ABU N	2488600000

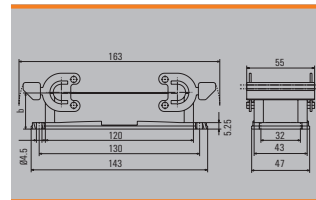

Note: N = Plastic locking lever with stainless steel inlay

Base housing



a	Version	Cover	b (mm)	Type	Order No.
M 25	Side-locking		64	HDC 24B SBU 2M25G	1787870000
M 25	Side-locking		64	HDC 24B SBU 2M25G N	2560970000
M 25	Side-locking		84	HDC 64D SBU 2M25G	1786890000
M 32	Side-locking		84	HDC 64D SBU 2M25G N	2561060000
M 32	Side-locking		84	HDC 64D SBU 1M32G N	2561050000
M 32	Side-locking		84	HDC 64D SBU 2M32G	1786880000

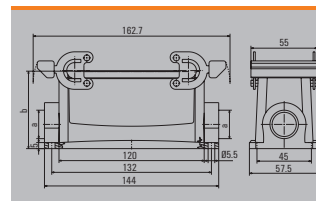

Note: N = Plastic locking lever with stainless steel inlay

Coupling housing



a	Version	Cover	b (mm)	Type	Order No.
M 25	w. thread		65	HDC 24B KBU 1M25G	1787920000
M 25	w. thread		65	HDC 24B KBU 1M25G N	2559870000
M 32	w. thread		65	HDC 24B KBU 2M32G N	2559880000
M 32	w. thread		79	HDC 64D KBU 1M32G	1786960000
M 32	w. thread		79	HDC 64D KBU 1M32G N	2559910000

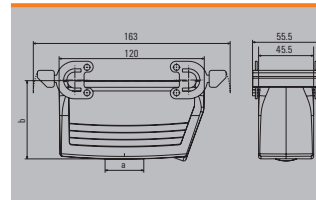

Note: N = Plastic locking lever with stainless steel inlay

Cover



Version	Type	Order No.
For bases	HDC 24B DDDQ 4B0	1665630000

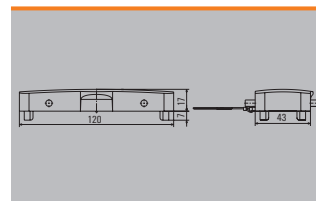

HD series

The HD series has a high contact density and is therefore particularly suitable for signal processing. The HD insert can be fitted with turned crimp contacts or fibre optic contacts – impressive flexibility.

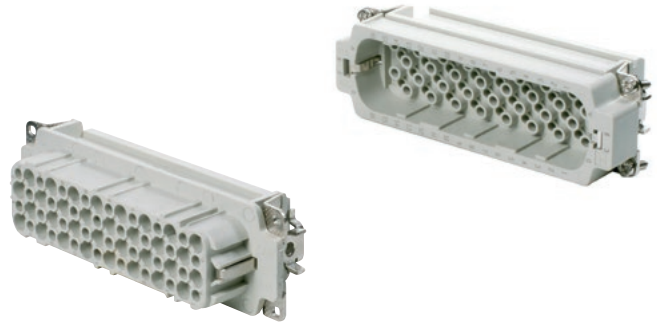



















Technical data

Standards/approvals	
Standards	DIN EN 61984 DIN EN 60664-1 DIN EN 175301-801
Approvals	UL/CSA
Inserts	
No. of poles	7, 15, 16, 25, 40, 50, 64, 80, 128 (+ PE), 8
Rated voltage	250 V
Rated voltage to UL/CSA	600 V
Rated current	10 A
Rated impulse withstand voltage	4 kV
Pollution severity	3
Insulation resistance	$\geq 10^{10} \Omega$
Material	Glass-fibre reinforced PC (in UL list and approved for railway applications)
Temperature range	-40 °C to +125 °C
Flammability to UL 94	V-0
Mechanical service life	
- Plugging cycles Ag - Surface	≥ 500
- Plugging cycles Au - Surface	≥ 500
Contact resistance	
Crimp connection	$\leq 4 \text{ m}\Omega$
Contacts/Material	
Sockets and plug-in contact	Copper alloy
Surface	Passivated silver, or gold-plated
Crimp connection	
- Flexible conductor connection	0.14 - 2.5 mm ² (AWG 26 - 14)
- Stripping length	8.0 mm
PE connection	
- Clamping range	0.5 - 2.5 mm ²
- solid/stranded	0.5 - 2.5 mm ² / 0.5 - 2.5 mm ²
- flexible/flexible with wire end ferrule, DIN 46228 pt. 1	0.5 - 2.5 mm ² / 0.5 - 2.5 mm ²
- AWG conductor	AWG 20 - 14
- Stripping length	10 mm
- Clamping torque	1.2 - 1.5 Nm
- Blade dimensions	SD 0.8 x 4 mm or PZ1

Note:
For inserts with 15 or more poles, the earthing (ground) is made with a screw connection. When used properly and as designated, the listed connectors may not be connected or disconnected if there is a live voltage or load!
The HD 8 does not feature an earthing connection.

When using connectors with high contact density, we recommend the use of guide pins and sockets; see Chapter I.

Overview

		Size	Rated voltage	Rated current	No. of poles	Tension clamp connection	TOP connection	Screw conn. with wire guard spring	Crimp connection	PUSH IN connection	Page
		1	250 V	10 A	7 + ⊕				•		B.52
		1	42 V	10 A	8				•		B.54
		2	250 V	10 A	15 + ⊕				•		B.56
		5	250 V	10 A	25 + ⊕				•		B.58
		6	250 V	10 A	40 + ⊕				•		B.60
		7	250 V	10 A	50 + ⊕				•		B.62
		8	250 V	10 A	64 + ⊕				•		B.64
		10	250 V	10 A	80 + ⊕				•		B.66
		12	250 V	10 A	128 + ⊕				•		B.68

250 V, 10 A, size 1

7 + ⊕

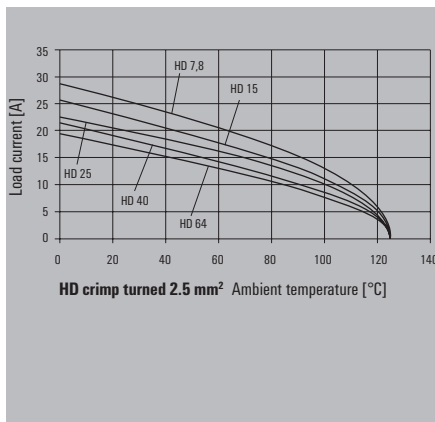
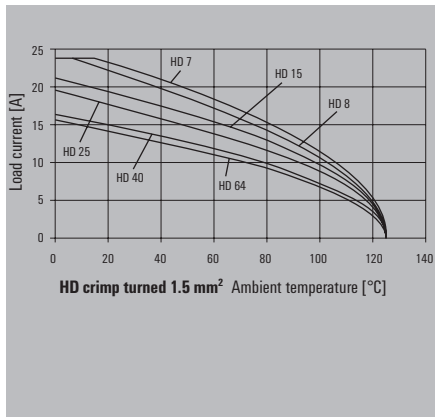

Installation cut-out

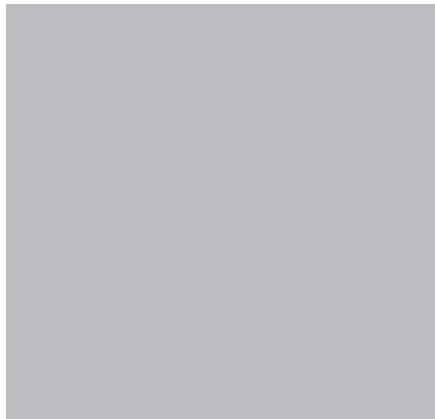

Male

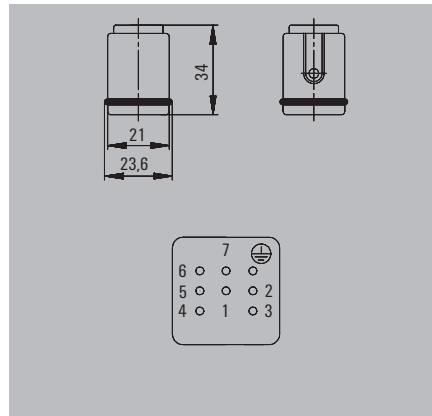

Ordering data

Type of connection	Type	Qty.	Order No.
Crimp connection	HDC HD 7 MC	1	1650570000

Can only be used in plastic housings.

Accessories

Type	Qty.	Order No.
Crimp contacts, male - gold		
HDC-C-HD-SM0.14-0.37AU	100	1651620000
HDC-C-HD-SM0.5AU	100	1651630000
HDC-C-HD-SM0.75-1.00AU	100	1651640000
HDC-C-HD-SM1.5AU	100	1651650000
HDC-C-HD-SM2.5AU	100	1651660000
Crimp contacts, male - silver		
HDC-C-HD-SM0.14-0.37AG	100	1651520000
HDC-C-HD-SM0.5AG	100	1651530000
HDC-C-HD-SM0.75-1.00AG	100	1601750000
HDC-C-HD-SM1.5AG	100	1651550000
HDC-C-HD-SM2.5AG	100	1651560000
Tools		
CTX CM 1.6/2.5	1	9018490000
REMOVAL TOOL HD	1	1866730000

Female

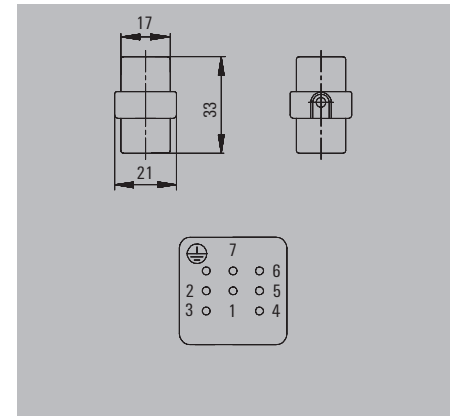

Ordering data

Type of connection	Type	Qty.	Order No.
Crimp connection	HDC HD 7 FC	1	1650580000

Can only be used in plastic housings.

Accessories

Type	Qty.	Order No.
Crimp contacts, female - gold		
HDC-C-HD-BM0.14-0.37AU	100	1651670000
HDC-C-HD-BM0.5AU	100	1651680000
HDC-C-HD-BM0.75-1.00AU	100	1651690000
HDC-C-HD-BM1.5AU	100	1651700000
HDC-C-HD-BM2.5AU	100	1651710000
Crimp contacts, female - silver		
HDC-C-HD-BM0.14-0.37AG	100	1651570000
HDC-C-HD-BM0.5AG	100	1651580000
HDC-C-HD-BM0.75-1.00AG	100	1601760000
HDC-C-HD-BM1.5AG	100	1651600000
HDC-C-HD-BM2.5AG	100	1651610000
Tools		
CTX CM 1.6/2.5	1	9018490000
REMOVAL TOOL HD	1	1866730000

Housing selection RockStar® IP65
Size 1



For additional housings, refer to
Chapter D for IP65 / Chapter F for IP68 EMC

Hood

Plug housing, cable entry sideways



Material: Plastic

a	Version	Cover	b (mm)	Type	Order No.
M 20	w. thread		49.2	HDC 07A TWLU 1M20G	1788510000

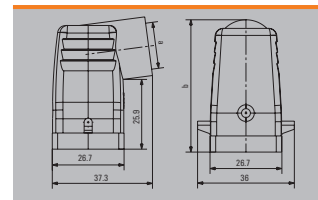

Plug housing, cable entry at top



Material: Plastic

a	Version	Cover	b (mm)	Type	Order No.
M 20	w. thread		50	HDC 07A TOLU 1M20G	1788520000

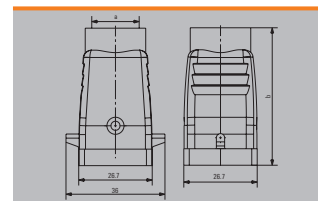

Base

Bulkhead housing



Material: Plastic

Version	Cover	b (mm)	Type	Order No.
Side-locking		23	HDC 07A ALU	1652410000

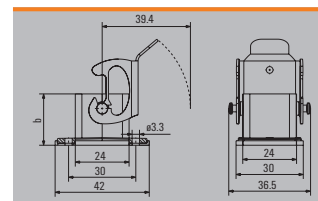

Base housing



Material: Plastic

a	Version	Cover	b (mm)	Type	Order No.
M 20	Side-locking		41.5	HDC 07A SLU 1M20G	1788530000

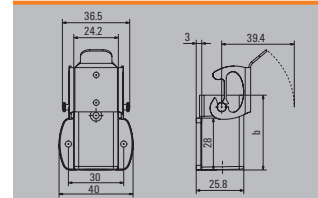

Coupling housing



Material: Plastic

a	Version	Cover	b (mm)	Type	Order No.
M 20	w. thread		53.5	HDC 07A KOLU 1M20G	1788540000

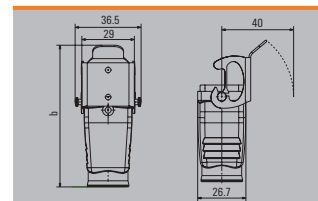

Screw mounting housing



Material: Plastic

a	Version	Cover	b (mm)	Type	Order No.
PG 13.5	w. thread		54	HDC 07A ELU 1PG13G	1900990000

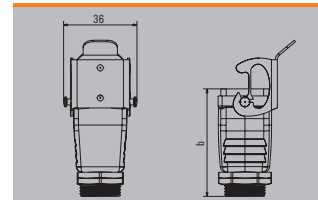

Cover



Material: Plastic

Version	Type	Order No.
with female	HDC 07A DMDL 2B0	1665770000
with male	HDC 07A DODL 2B0	1665760000

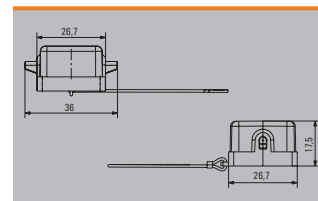

50 V, 10 A, size 1

8

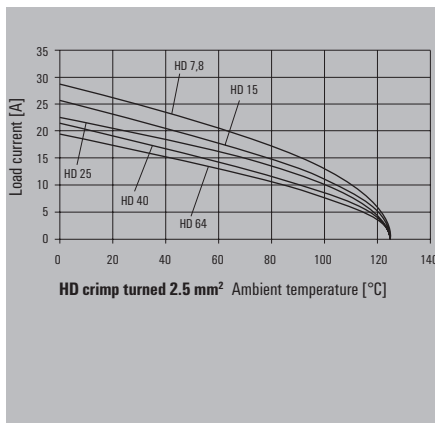
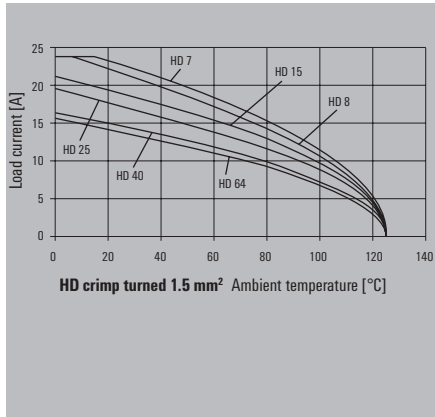

Installation cut-out



Male

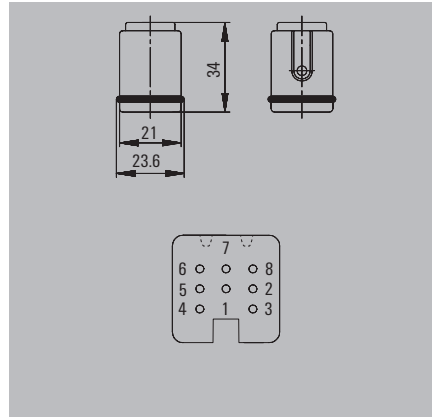

Ordering data

Type of connection	Type	Qty.	Order No.
Crimp connection	HDC HD 8 MC	1	1650590000

Accessories

Type	Qty.	Order No.
Crimp contacts, male - gold		
HDC-C-HD-SM0.14-0.37AU	100	1651620000
HDC-C-HD-SM0.5AU	100	1651630000
HDC-C-HD-SM0.75-1.00AU	100	1651640000
HDC-C-HD-SM1.5AU	100	1651650000
HDC-C-HD-SM2.5AU	100	1651660000
Crimp contacts, male - silver		
HDC-C-HD-SM0.14-0.37AG	100	1651520000
HDC-C-HD-SM0.5AG	100	1651530000
HDC-C-HD-SM0.75-1.00AG	100	1601750000
HDC-C-HD-SM1.5AG	100	1651550000
HDC-C-HD-SM2.5AG	100	1651560000
Tools		
CTX CM 1.6/2.5	1	9018490000
REMOVAL TOOL HD	1	1866730000

Female

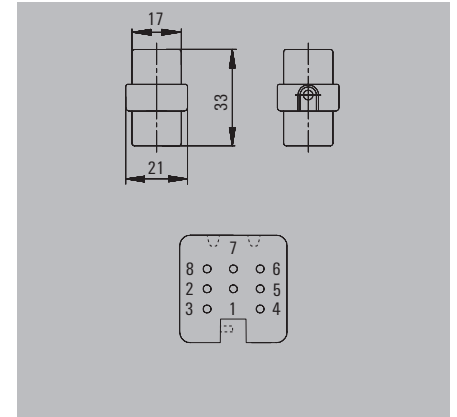

Ordering data

Type of connection	Type	Qty.	Order No.
Crimp connection	HDC HD 8 FC	1	1650600000

Accessories

Type	Qty.	Order No.
Crimp contacts, female - gold		
HDC-C-HD-BM0.14-0.37AU	100	1651670000
HDC-C-HD-BM0.5AU	100	1651680000
HDC-C-HD-BM0.75-1.00AU	100	1651690000
HDC-C-HD-BM1.5AU	100	1651700000
HDC-C-HD-BM2.5AU	100	1651710000
Crimp contacts, female - silver		
HDC-C-HD-BM0.14-0.37AG	100	1651570000
HDC-C-HD-BM0.5AG	100	1651580000
HDC-C-HD-BM0.75-1.00AG	100	1601760000
HDC-C-HD-BM1.5AG	100	1651600000
HDC-C-HD-BM2.5AG	100	1651610000
Tools		
CTX CM 1.6/2.5	1	9018490000
REMOVAL TOOL HD	1	1866730000

Housing selection RockStar® IP65
Size 1



For additional housings, refer to
Chapter D for IP65 / Chapter F for IP68 EMC

Hood

Plug housing, cable entry sideways



Material: Plastic

a	Version	Cover	b (mm)	Type	Order No.
M 20	w. thread		49.2	HDC 07A TWLU 1M20G	1788510000

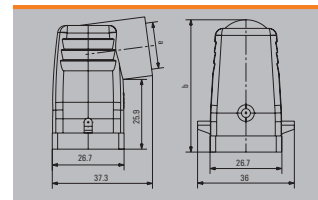

Plug housing, cable entry at top



Material: Plastic

a	Version	Cover	b (mm)	Type	Order No.
M 20	w. thread		50	HDC 07A TOLU 1M20G	1788520000

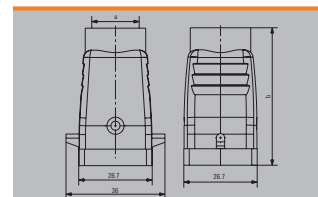

Base

Bulkhead housing



Material: Plastic

Version	Cover	b (mm)	Type	Order No.
Side-locking		23	HDC 07A ALU	1652410000

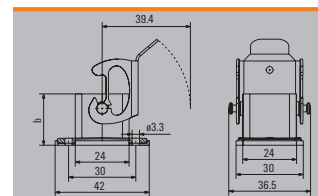

Base housing



Material: Plastic

a	Version	Cover	b (mm)	Type	Order No.
M 20	Side-locking		41.5	HDC 07A SLU 1M20G	1788530000

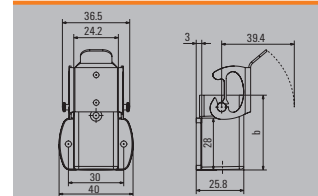

Coupling housing



Material: Plastic

a	Version	Cover	b (mm)	Type	Order No.
M 20	w. thread		53.5	HDC 07A KOLU 1M20G	1788540000

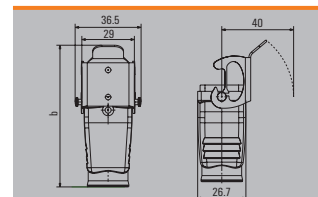

Screw mounting housing



Material: Plastic

a	Version	Cover	b (mm)	Type	Order No.
PG 13.5	w. thread		54	HDC 07A ELU 1PG13G	1900990000

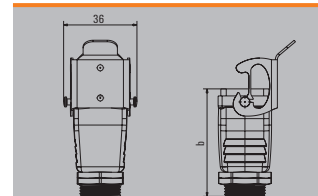

Cover



Material: Plastic

Version	Type	Order No.
with female	HDC 07A DMDL 2B0	1665770000
with male	HDC 07A DODL 2B0	1665760000

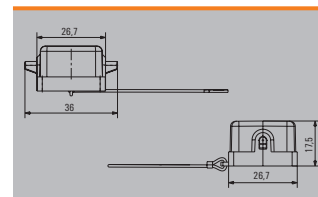

250 V, 10 A, size 2

15 + ⊕

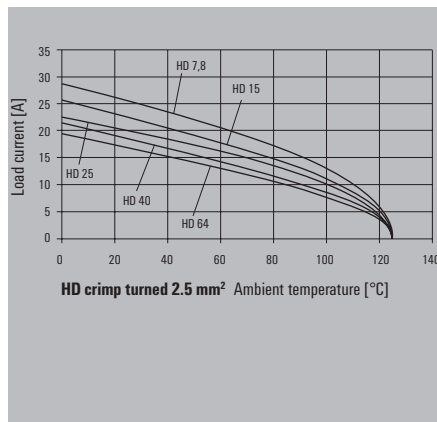
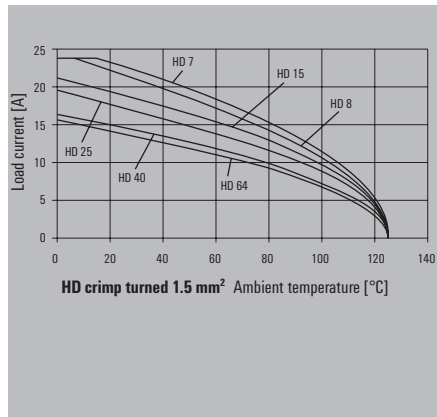

Installation cut-out

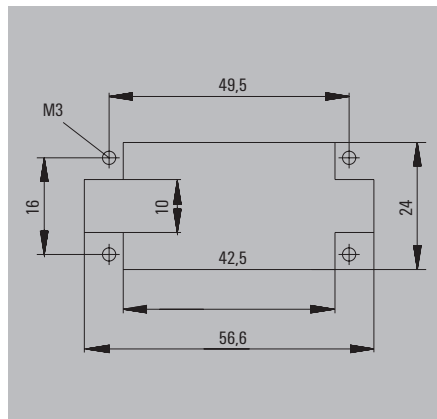

Male

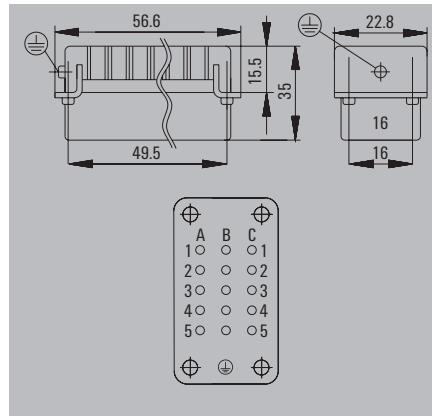

Ordering data

Type of connection	Type	Qty.	Order No.
Crimp connection	HDC HD 15 MC	1	1650650000

Accessories

Type	Qty.	Order No.
Crimp contacts, male - gold		
HDC-C-HD-SM0.14-0.37AU	100	1651620000
HDC-C-HD-SM0.5AU	100	1651630000
HDC-C-HD-SM0.75-1.00AU	100	1651640000
HDC-C-HD-SM1.5AU	100	1651650000
HDC-C-HD-SM2.5AU	100	1651660000
Crimp contacts, male - silver		
HDC-C-HD-SM0.14-0.37AG	100	1651520000
HDC-C-HD-SM0.5AG	100	1651530000
HDC-C-HD-SM0.75-1.00AG	100	1601750000
HDC-C-HD-SM1.5AG	100	1651550000
HDC-C-HD-SM2.5AG	100	1651560000
Tools		
CTX CM 1.6/2.5	1	9018490000
REMOVAL TOOL HD	1	1866730000

Female

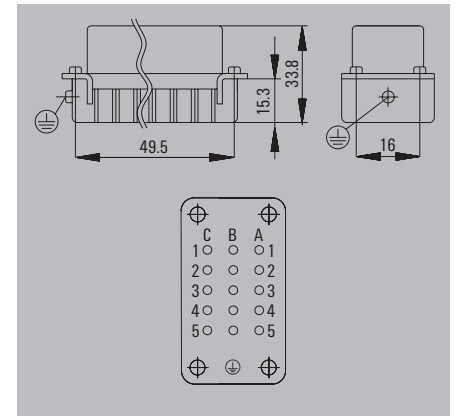
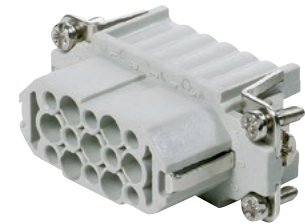

Ordering data

Type of connection	Type	Qty.	Order No.
Crimp connection	HDC HD 15 FC	1	1650660000

Accessories

Type	Qty.	Order No.
Crimp contacts, female - gold		
HDC-C-HD-BM0.14-0.37AU	100	1651670000
HDC-C-HD-BM0.5AU	100	1651680000
HDC-C-HD-BM0.75-1.00AU	100	1651690000
HDC-C-HD-BM1.5AU	100	1651700000
HDC-C-HD-BM2.5AU	100	1651710000
Crimp contacts, female - silver		
HDC-C-HD-BM0.14-0.37AG	100	1651570000
HDC-C-HD-BM0.5AG	100	1651580000
HDC-C-HD-BM0.75-1.00AG	100	1601760000
HDC-C-HD-BM1.5AG	100	1651600000
HDC-C-HD-BM2.5AG	100	1651610000
Tools		
CTX CM 1.6/2.5	1	9018490000
REMOVAL TOOL HD	1	1866730000

Housing selection RockStar® IP65
Size 2



For additional housings, refer to chapter D for IP65

Hood

Plug housing, cable entry sideways



a	Version	Cover	b (mm)	Type	Order No.
M 20	w. thread		68	HDC 15A TSLU 1M20G	1788860000
M 25	w. thread		68	HDC 15A TSLU 1M25G	1788850000

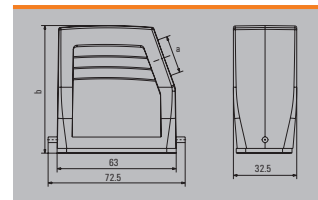

Plug housing, cable entry at top



a	Version	Cover	b (mm)	Type	Order No.
M 20	w. thread		54	HDC 10A TOLL 1M20G	1788620000
M 25	w. thread		54	HDC 10A TOLL 1M25G	1788610000

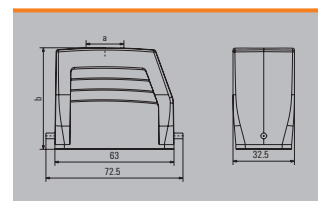

Cover



Version	Type	Order No.
For hoods	HDC 10A DDDL 1LB	1665890000

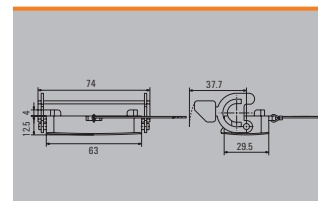

Base

Bulkhead housing



Version	Cover	b (mm)	Type	Order No.
End-locking	without cover	25	HDC 10A ALU	1664040000
End-locking	with cover	37.5	HDC 10A ADLU	1664060000

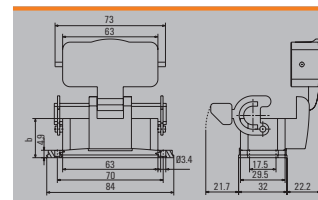

Base housing



a	Version	Cover	b (mm)	Type	Order No.
M 20	End-locking		57	HDC 10A SLU 2M20G	1788640000
M 20	End-locking	with cover	69.5	HDC 10A SDLU 2M20G	1788660000
M 25	End-locking		57	HDC 10A SLU 2M25G	1788630000
M 25	End-locking	with cover	69.5	HDC 10A SDLU 2M25G	1788650000

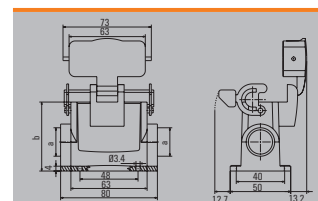

Coupling housing



a	Version	Cover	b (mm)	Type	Order No.
M 25	w. thread		48	HDC 10A KLU 1M25G	1788670000

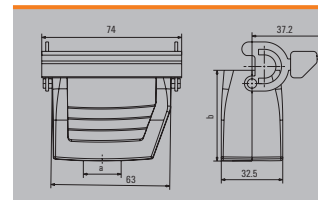

Cover



Version	Type	Order No.
For bases	HDC 10A DMDL 2B0	1665880000

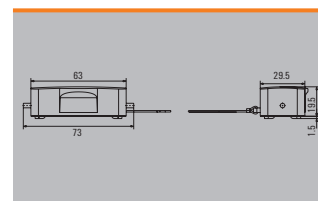

250 V, 10 A, size 5

25 + ⊕

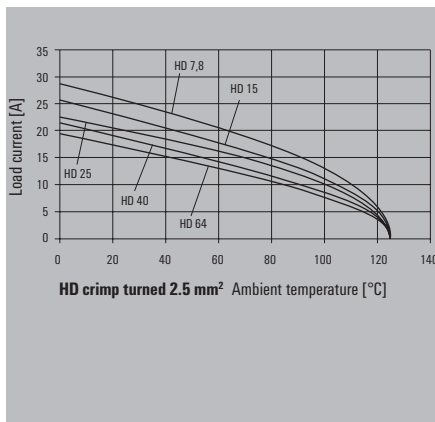
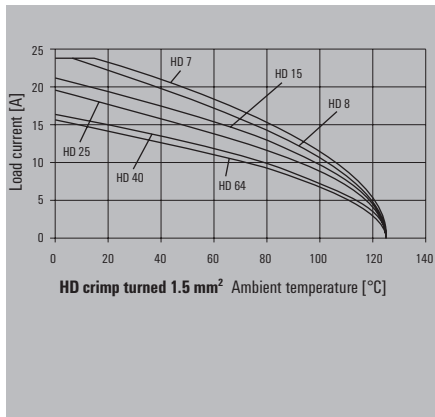

Installation cut-out

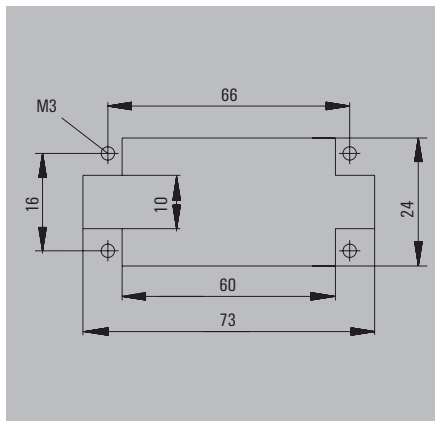

Male

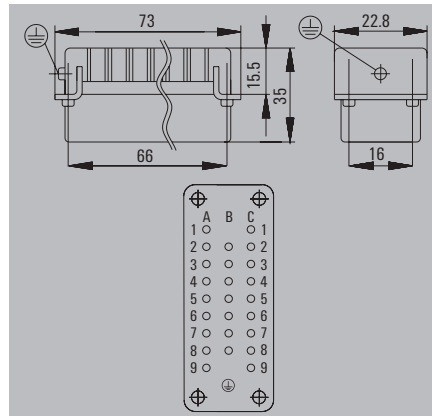

Ordering data

Type of connection	Type	Qty.	Order No.
Crimp connection	HDC HD 25 MC	1	1650810000

Please use this insert type doubled for size 7 (50-pole). We recommend the use of guide pins and sockets.

Accessories

Type	Qty.	Order No.
Crimp contacts, male - gold		
HDC-C-HD-SM0.14-0.37AU	100	1651620000
HDC-C-HD-SM0.5AU	100	1651630000
HDC-C-HD-SM0.75-1.00AU	100	1651640000
HDC-C-HD-SM1.5AU	100	1651650000
HDC-C-HD-SM2.5AU	100	1651660000
Crimp contacts, male - silver		
HDC-C-HD-SM0.14-0.37AG	100	1651520000
HDC-C-HD-SM0.5AG	100	1651530000
HDC-C-HD-SM0.75-1.00AG	100	1601750000
HDC-C-HD-SM1.5AG	100	1651550000
HDC-C-HD-SM2.5AG	100	1651560000
Tools		
CTX CM 1.6/2.5	1	9018490000
REMOVAL TOOL HD	1	1866730000

Female

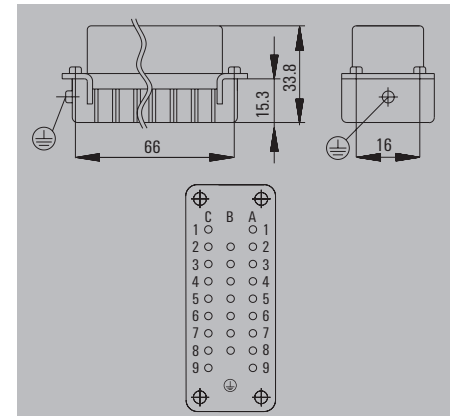

Ordering data

Type of connection	Type	Qty.	Order No.
Crimp connection	HDC HD 25 FC	1	1650820000

Please use this insert type doubled for size 7 (50-pole). We recommend the use of guide pins and sockets.

Accessories

Type	Qty.	Order No.
Crimp contacts, female - gold		
HDC-C-HD-BM0.14-0.37AU	100	1651670000
HDC-C-HD-BM0.5AU	100	1651680000
HDC-C-HD-BM0.75-1.00AU	100	1651690000
HDC-C-HD-BM1.5AU	100	1651700000
HDC-C-HD-BM2.5AU	100	1651710000
Crimp contacts, female - silver		
HDC-C-HD-BM0.14-0.37AG	100	1651570000
HDC-C-HD-BM0.5AG	100	1651580000
HDC-C-HD-BM0.75-1.00AG	100	1601760000
HDC-C-HD-BM1.5AG	100	1651600000
HDC-C-HD-BM2.5AG	100	1651610000
Tools		
CTX CM 1.6/2.5	1	9018490000
REMOVAL TOOL HD	1	1866730000

Housing selection RockStar® IP65
Size 5



For additional housings, refer to chapter D for IP65

Hood

Plug housing, cable entry sideways



a	Version	Cover	b (mm)	Type	Order No.
M 20	w. thread		72	HDC 25A TSLU 1M20G	1788680000
M 25	w. thread		58	HDC 16A TSLU 1M25G	1788740000
M 25	w. thread		72	HDC 25A TSLU 1M25G	1788690000

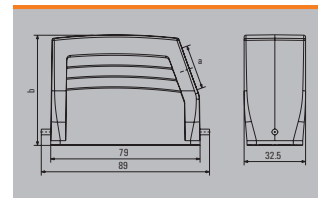

Plug housing, cable entry at top



a	Version	Cover	b (mm)	Type	Order No.
M 20	w. thread		72	HDC 25A TOLU 1M20G	1788710000
M 25	w. thread		58	HDC 16A TOLU 1M25G	1788750000
M 25	w. thread		72	HDC 25A TOLU 1M25G	1788700000

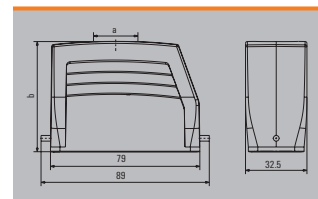

Cover



Version	Type	Order No.
For hoods	HDC 16A DDDL 1LB	1665900000

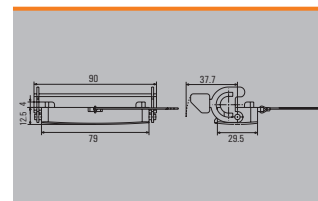

Base

Bulkhead housing



Version	Cover	b (mm)	Type	Order No.
End-locking	without cover	26.25	HDC 16A ALU	1664920000
End-locking	with cover	26.25	HDC 16A ADLU	1664940000

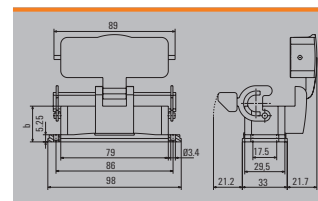

Base housing



a	Version	Cover	b (mm)	Type	Order No.
M 20	End-locking		57	HDC 16A SLU 2M20G	1788770000
M 20	End-locking	with cover	57	HDC 16A SDLU 2M20G	1788790000
M 25	End-locking		57	HDC 16A SLU 2M25G	1788760000
M 25	End-locking	with cover	57	HDC 16A SDLU 2M25G	1788780000

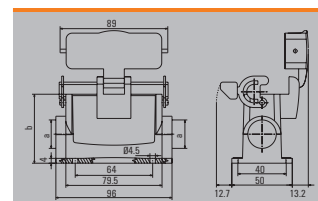

Coupling housing



a	Version	Cover	b (mm)	Type	Order No.
M 25	w. thread		52.62	HDC 16A KLU 1M25G	1788800000

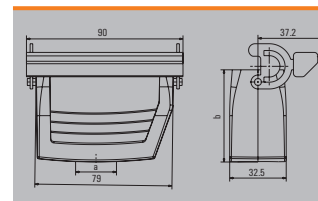

Cover



Version	Type	Order No.
For bases	HDC 16A DMDL 2B0	1665910000

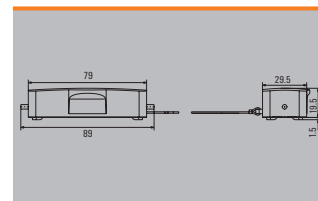

250 V, 10 A, size 6

40 + ⊕

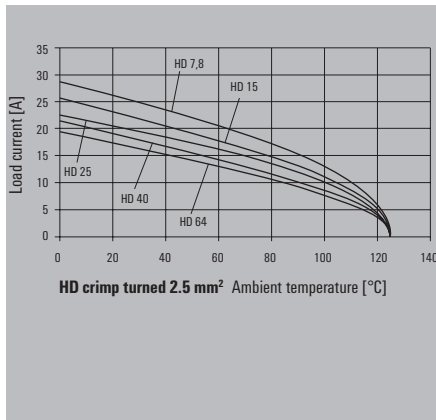
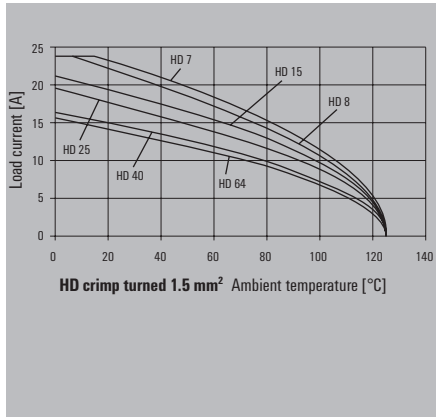

Installation cut-out

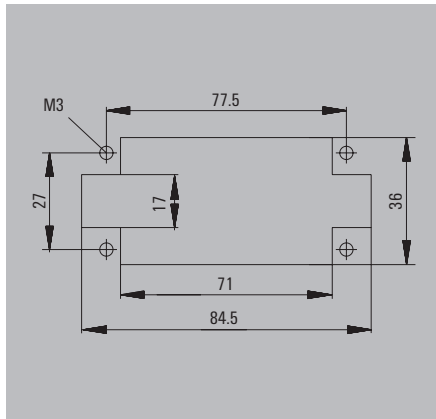

Male

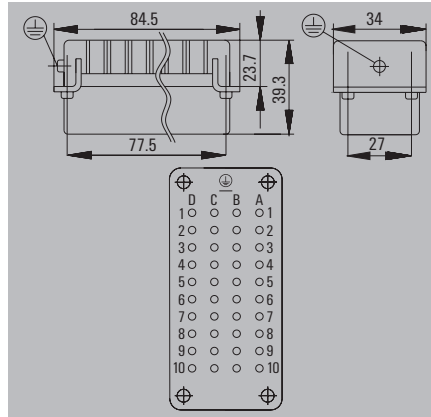
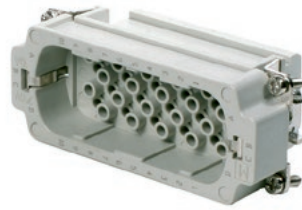

Ordering data

Type of connection	Type	Qty.	Order No.
Crimp connection	HDC HD 40 MC	1	1601710000

Please use this insert type doubled for size 10 (80-pole). We recommend the use of guide pins and sockets.

Accessories

Type	Qty.	Order No.
Crimp contacts, male - gold		
HDC-C-HD-SM0.14-0.37AU	100	1651620000
HDC-C-HD-SM0.5AU	100	1651630000
HDC-C-HD-SM0.75-1.00AU	100	1651640000
HDC-C-HD-SM1.5AU	100	1651650000
HDC-C-HD-SM2.5AU	100	1651660000
Crimp contacts, male - silver		
HDC-C-HD-SM0.14-0.37AG	100	1651520000
HDC-C-HD-SM0.5AG	100	1651530000
HDC-C-HD-SM0.75-1.00AG	100	1601750000
HDC-C-HD-SM1.5AG	100	1651550000
HDC-C-HD-SM2.5AG	100	1651560000
Tools		
CTX CM 1.6/2.5	1	9018490000
REMOVAL TOOL HD	1	1866730000

Female

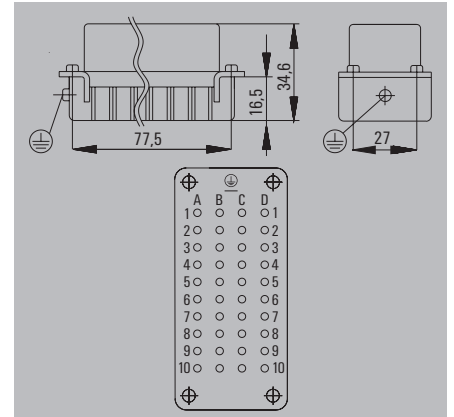

Ordering data

Type of connection	Type	Qty.	Order No.
Crimp connection	HDC HD 40 FC	1	1601730000

Please use this insert type doubled for size 10 (80-pole). We recommend the use of guide pins and sockets.

Accessories

Type	Qty.	Order No.
Crimp contacts, female - gold		
HDC-C-HD-BM0.14-0.37AU	100	1651670000
HDC-C-HD-BM0.5AU	100	1651680000
HDC-C-HD-BM0.75-1.00AU	100	1651690000
HDC-C-HD-BM1.5AU	100	1651700000
HDC-C-HD-BM2.5AU	100	1651710000
Crimp contacts, female - silver		
HDC-C-HD-BM0.14-0.37AG	100	1651570000
HDC-C-HD-BM0.5AG	100	1651580000
HDC-C-HD-BM0.75-1.00AG	100	1601760000
HDC-C-HD-BM1.5AG	100	1651600000
HDC-C-HD-BM2.5AG	100	1651610000
Tools		
CTX CM 1.6/2.5	1	9018490000
REMOVAL TOOL HD	1	1866730000

Housing selection RockStar® IP65
Size 6



For additional housings, refer to
Chapter D for IP65 / Chapter E for IP65 EMC /
Chapter F for IP68 EMC

Hood

Plug housing, cable entry sideways



a	Version	Cover	b (mm)	Type	Order No.
M 25	w. thread		61	HDC 16B TSBU 1M25G	1788180000
M 25	w. thread		76	HDC 40D TSBU 1M25G	1787010000
M 32	w. thread		76	HDC 40D TSBU 1M32G	1787000000

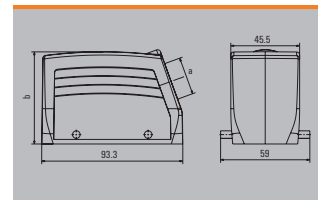

Plug housing, cable entry at top



a	Version	Cover	b (mm)	Type	Order No.
M 25	w. thread		61	HDC 16B TOBU 1M25G	1788210000
M 25	w. thread		76	HDC 40D TOBU 1M25G	1787070000
M 32	w. thread		76	HDC 40D TOBU 1M32G	1787060000

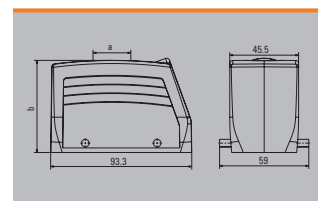

Cover



Version	Type	Order No.
For hoods	HDC 16B DMDQ 2QB	1665270000

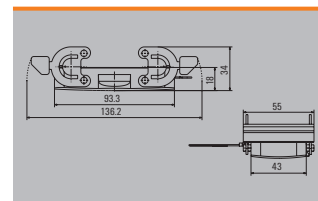

Base

Bulkhead housing



Version	Cover	b (mm)	Type	Order No.
Side-locking		29	HDC 16B ABU	1208600000
Side-locking		29	HDC 16B ABU N	2488590000

Note: N = Plastic locking lever with stainless steel inlay

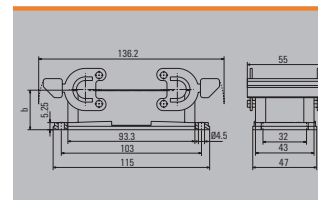

Base housing



a	Version	Cover	b (mm)	Type	Order No.
M 25	Side-locking		64	HDC 16B SBU 1M25G N	2560740000
M 25	Side-locking		64	HDC 16B SBU 2M25G	1788240000
M 25	Side-locking		64	HDC 16B SBU 2M25G N	2560930000
M 25	Side-locking		84	HDC 40D SBU 2M25G	1787120000
PG 21	Side-locking		84	HDC 40D SBU 1M32G N	2561030000
M 32	Side-locking		84	HDC 40D SBU 2M32G	1787110000

Note: N = Plastic locking lever with stainless steel inlay

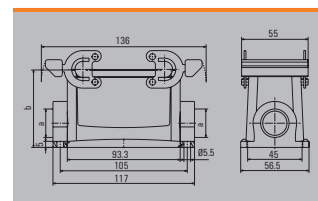

Coupling housing



a	Version	Cover	b (mm)	Type	Order No.
M 25	w. thread		78.6	HDC 40D KBU 1M25G	1787200000
PG 29	w. thread		79	HDC 40D KBU 1M25G N	2559890000
M 32	w. thread		78.6	HDC 40D KBU 1M32G	1787190000
PG 29	w. thread		79	HDC 40D KBU 1M32G N	2559900000
PG 29	w. thread		79	HDC 40D KBU 2M32G N	2545510000

Note: N = Plastic locking lever with stainless steel inlay

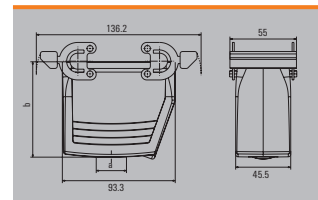

Cover



Version	Type	Order No.
For bases	HDC 16B DDDQ 4B0	1665260000

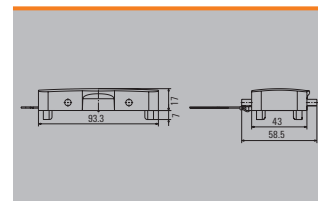

250 V, 10 A, size 7

50 + ⊕

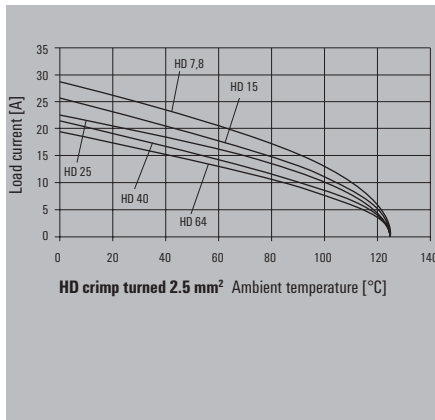
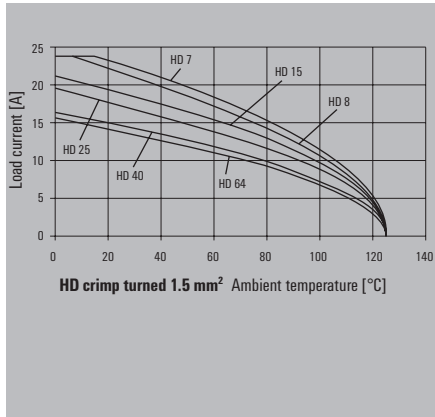

Installation cut-out

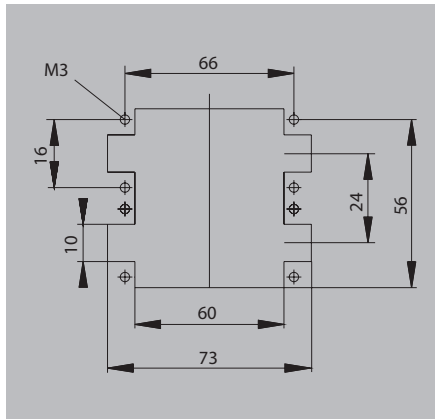

Male

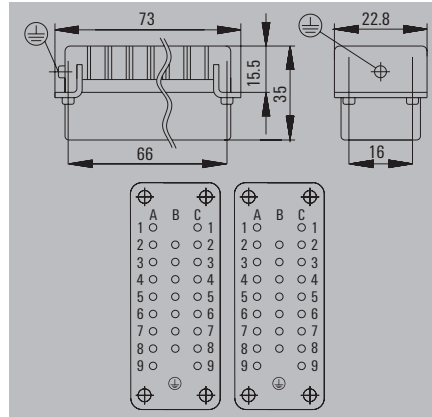

Ordering data

Type of connection	Type	Qty.	Order No.
Crimp connection	HDC HD 25 MC	1	1650810000
Crimp connection	HDC HD 25 MC Z	1	1023040000

Please use this insert type doubled for size 7 (50-pole). We recommend the use of guide pins and sockets.

Accessories

Type	Qty.	Order No.
Crimp contacts, male - gold		
HDC-C-HD-SM0.14-0.37AU	100	1651620000
HDC-C-HD-SM0.5AU	100	1651630000
HDC-C-HD-SM0.75-1.00AU	100	1651640000
HDC-C-HD-SM1.5AU	100	1651650000
HDC-C-HD-SM2.5AU	100	1651660000
Crimp contacts, male - silver		
HDC-C-HD-SM0.14-0.37AG	100	1651520000
HDC-C-HD-SM0.5AG	100	1651530000
HDC-C-HD-SM0.75-1.00AG	100	1601750000
HDC-C-HD-SM1.5AG	100	1651550000
HDC-C-HD-SM2.5AG	100	1651560000
Tools		
CTX CM 1.6/2.5	1	9018490000
REMOVAL TOOL HD	1	1866730000

Female

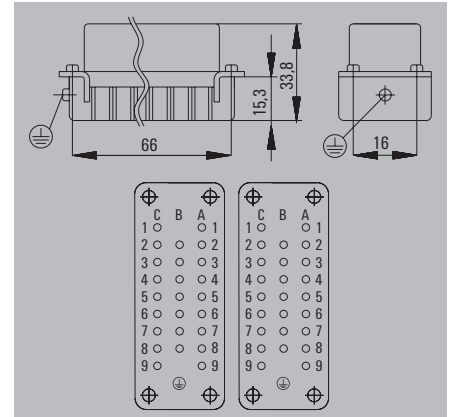

Ordering data

Type of connection	Type	Qty.	Order No.
Crimp connection	HDC HD 25 FC	1	1650820000
Crimp connection	HDC HD 25 FC Z	1	1023050000

Please use this insert type doubled for size 7 (50-pole). We recommend the use of guide pins and sockets.

Accessories

Type	Qty.	Order No.
Crimp contacts, female - gold		
HDC-C-HD-BM0.14-0.37AU	100	1651670000
HDC-C-HD-BM0.5AU	100	1651680000
HDC-C-HD-BM0.75-1.00AU	100	1651690000
HDC-C-HD-BM1.5AU	100	1651700000
HDC-C-HD-BM2.5AU	100	1651710000
Crimp contacts, female - silver		
HDC-C-HD-BM0.14-0.37AG	100	1651570000
HDC-C-HD-BM0.5AG	100	1651580000
HDC-C-HD-BM0.75-1.00AG	100	1601760000
HDC-C-HD-BM1.5AG	100	1651600000
HDC-C-HD-BM2.5AG	100	1651610000
Tools		
CTX CM 1.6/2.5	1	9018490000
REMOVAL TOOL HD	1	1866730000

Housing selection RockStar® IP65
Size 7



For additional housings, refer to
chapter D for IP65

Hood

Plug housing, cable entry sideways



a	Version	Cover	b (mm)	Type	Order No.
M 25	w. thread		77	HDC 32A TSBU 1M25G	1787960000
M 32	w. thread		77	HDC 32A TSBU 1M32G	1787950000

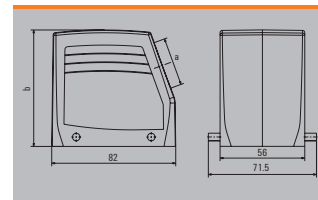

Plug housing, cable entry at top



a	Version	Cover	b (mm)	Type	Order No.
M 32	w. thread		77	HDC 32A TOBU 1M32G	1787990000

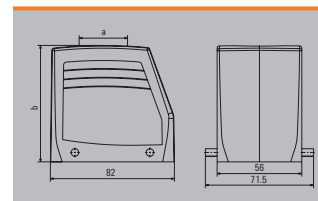

Base

Bulkhead housing



Version	Cover	b (mm)	Type	Order No.
Side-locking		30	HDC 32A ABU	1665860000

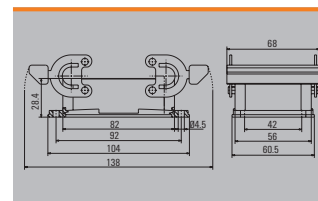

Base housing



a	Version	Cover	b (mm)	Type	Order No.
M 25	Side-locking		75	HDC 32A SBU 2M25G	1788040000

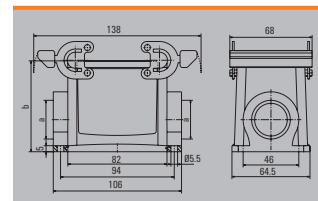

Coupling housing



a	Version	Cover	b (mm)	Type	Order No.
M 25	w. thread		77	HDC 32A KBU 1M25G	1788080000
M 32	w. thread		77	HDC 32A KBU 1M32G	1788070000

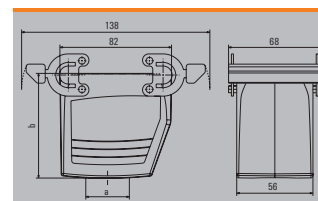

HD series

250 V, 10 A, size 8

64 + ⊕

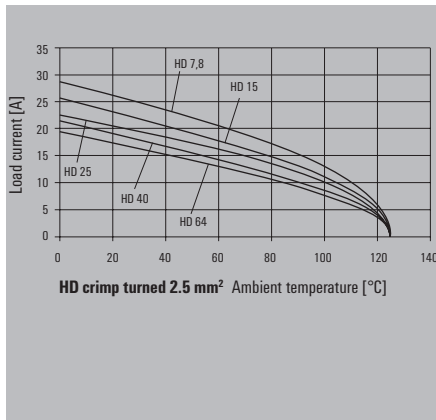
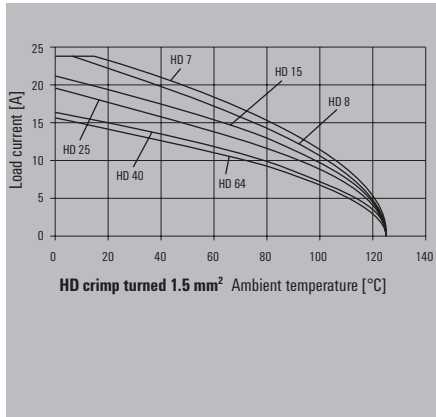

Installation cut-out

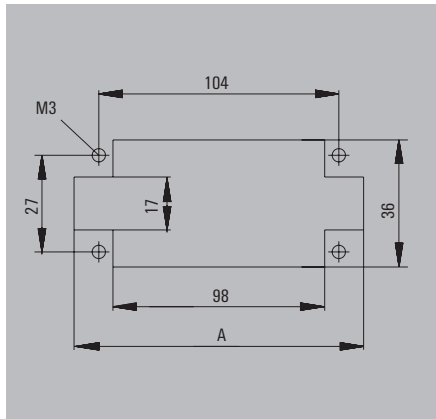

Male

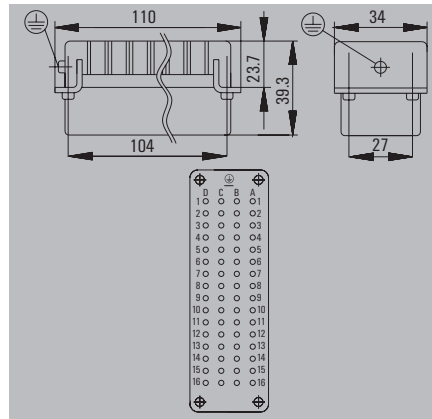

Ordering data

Type of connection	Type	Qty.	Order No.
Crimp connection	HDC HD 64 MC	1	1601720000

Please use this insert type doubled for size 12 (128-pole). We recommend the use of guide pins and sockets.

Accessories

Type	Qty.	Order No.
Crimp contacts, male - gold		
HDC-C-HD-SM0.14-0.37AU	100	1651620000
HDC-C-HD-SM0.5AU	100	1651630000
HDC-C-HD-SM0.75-1.00AU	100	1651640000
HDC-C-HD-SM1.5AU	100	1651650000
HDC-C-HD-SM2.5AU	100	1651660000
Crimp contacts, male - silver		
HDC-C-HD-SM0.14-0.37AG	100	1651520000
HDC-C-HD-SM0.5AG	100	1651530000
HDC-C-HD-SM0.75-1.00AG	100	1601750000
HDC-C-HD-SM1.5AG	100	1651550000
HDC-C-HD-SM2.5AG	100	1651560000
Tools		
CTX CM 1.6/2.5	1	9018490000
REMOVAL TOOL HD	1	1866730000

Female

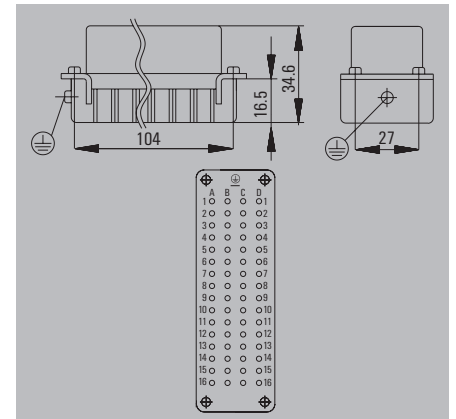

Ordering data

Type of connection	Type	Qty.	Order No.
Crimp connection	HDC HD 64 FC	1	1601740000

Please use this insert type doubled for size 12 (128-pole). We recommend the use of guide pins and sockets.

Accessories

Type	Qty.	Order No.
Crimp contacts, female - gold		
HDC-C-HD-BM0.14-0.37AU	100	1651670000
HDC-C-HD-BM0.5AU	100	1651680000
HDC-C-HD-BM0.75-1.00AU	100	1651690000
HDC-C-HD-BM1.5AU	100	1651700000
HDC-C-HD-BM2.5AU	100	1651710000
Crimp contacts, female - silver		
HDC-C-HD-BM0.14-0.37AG	100	1651570000
HDC-C-HD-BM0.5AG	100	1651580000
HDC-C-HD-BM0.75-1.00AG	100	1601760000
HDC-C-HD-BM1.5AG	100	1651600000
HDC-C-HD-BM2.5AG	100	1651610000
Tools		
CTX CM 1.6/2.5	1	9018490000
REMOVAL TOOL HD	1	1866730000

Housing selection RockStar® IP65
Size 8



For additional housings, refer to
Chapter D for IP65 / Chapter E for IP65 EMC /
Chapter F for IP68 EMC

Hood

Plug housing, cable entry sideways



a	Version	Cover	b (mm)	Type	Order No.
M 25	w. thread		62.58	HDC 24B TSBU 1M25G	1787760000
M 25	w. thread		76	HDC 64D TSBU 1M25G	1786780000
M 32	w. thread		62.58	HDC 24B TSBU 1M32G	1787750000
M 32	w. thread		76	HDC 64D TSBU 1M32G	1786770000

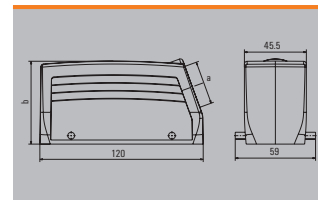

Plug housing, cable entry at top



a	Version	Cover	b (mm)	Type	Order No.
M 25	w. thread		62.58	HDC 24B TOBU 1M25G	1787820000
M 32	w. thread		62.58	HDC 24B TOBU 1M32G	1787810000
M 32	w. thread		76	HDC 64D TOBU 1M32G	1786830000

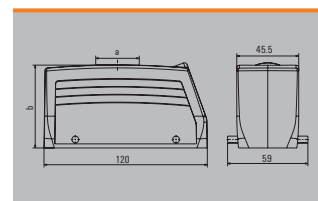

Cover



Version	Type	Order No.
For hoods	HDC 24B DMDQ 2QB	1665640000
For hoods	HDC 24B DMDQ 2QB N	2559760000

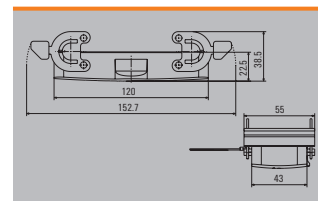

Note: N = Plastic locking lever with stainless steel inlay

Base

Bulkhead housing



Version	Cover	b (mm)	Type	Order No.
Side-locking		29.5	HDC 24B ABU	1212400000
Side-locking		29.5	HDC 24B ABU N	2488600000

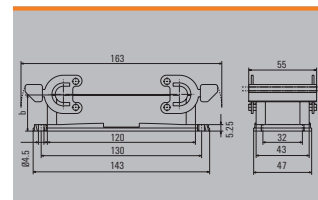

Note: N = Plastic locking lever with stainless steel inlay

Base housing



a	Version	Cover	b (mm)	Type	Order No.
M 25	Side-locking		64	HDC 24B SBU 2M25G	1787870000
M 25	Side-locking		64	HDC 24B SBU 2M25G N	2560970000
M 25	Side-locking		84	HDC 64D SBU 2M25G	1786890000
M 32	Side-locking		84	HDC 64D SBU 2M25G N	2561060000
M 32	Side-locking		84	HDC 64D SBU 1M32G N	2561050000
M 32	Side-locking		84	HDC 64D SBU 2M32G	1786880000

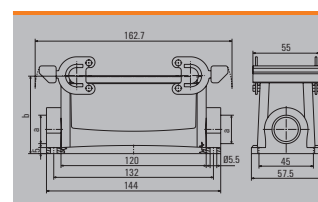

Note: N = Plastic locking lever with stainless steel inlay

Coupling housing



a	Version	Cover	b (mm)	Type	Order No.
M 25	w. thread		65	HDC 24B KBU 1M25G	1787920000
M 25	w. thread		65	HDC 24B KBU 1M25G N	2559870000
M 32	w. thread		65	HDC 24B KBU 2M32G N	2559880000
M 32	w. thread		79	HDC 64D KBU 1M32G	1786960000
M 32	w. thread		79	HDC 64D KBU 1M32G N	2559910000

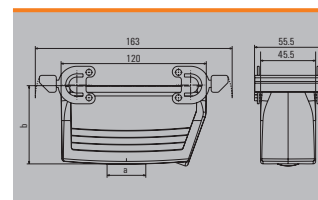

Note: N = Plastic locking lever with stainless steel inlay

Cover



Version	Type	Order No.
For bases	HDC 24B DDDQ 4B0	1665630000

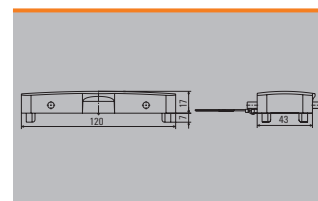

250 V, 10 A, size 10

80 + ⊕

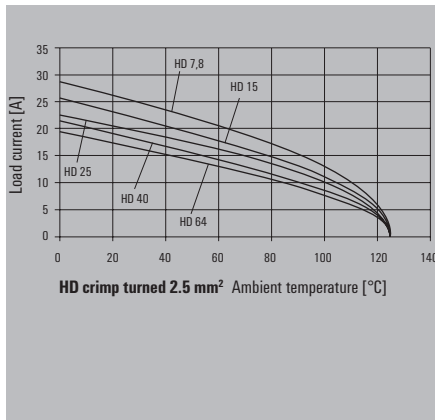
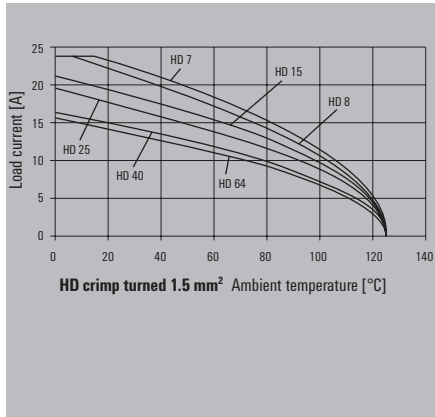

Installation cut-out

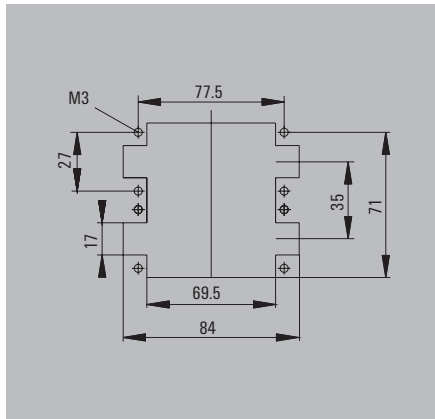

Male

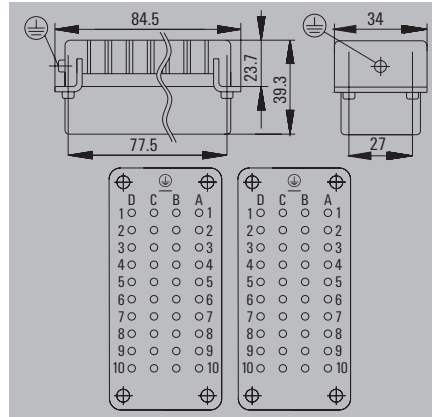

Ordering data

Type of connection	Type	Qty.	Order No.
Crimp connection	HDC HD 40 MC	1	1601710000

Please use this insert type doubled for size 10 (80-pole). We recommend the use of guide pins and sockets.

Accessories

Type	Qty.	Order No.
Crimp contacts, male - gold		
HDC-C-HD-SM0.14-0.37AU	100	1651620000
HDC-C-HD-SM0.5AU	100	1651630000
HDC-C-HD-SM0.75-1.00AU	100	1651640000
HDC-C-HD-SM1.5AU	100	1651650000
HDC-C-HD-SM2.5AU	100	1651660000
Crimp contacts, male - silver		
HDC-C-HD-SM0.14-0.37AG	100	1651520000
HDC-C-HD-SM0.5AG	100	1651530000
HDC-C-HD-SM0.75-1.00AG	100	1601750000
HDC-C-HD-SM1.5AG	100	1651550000
HDC-C-HD-SM2.5AG	100	1651560000
Tools		
CTX CM 1.6/2.5	1	9018490000
REMOVAL TOOL HD	1	1866730000

Female

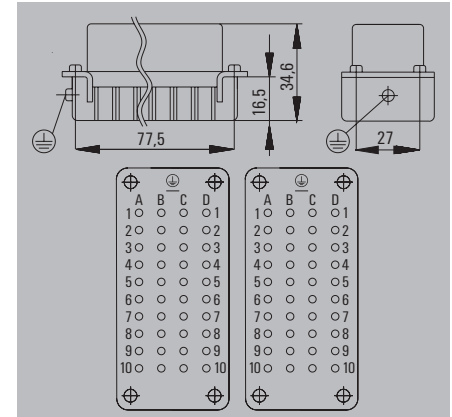

Ordering data

Type of connection	Type	Qty.	Order No.
Crimp connection	HDC HD 40 FC	1	1601730000

Please use this insert type doubled for size 10 (80-pole). We recommend the use of guide pins and sockets.

Accessories

Type	Qty.	Order No.
Crimp contacts, female - gold		
HDC-C-HD-BM0.14-0.37AU	100	1651670000
HDC-C-HD-BM0.5AU	100	1651680000
HDC-C-HD-BM0.75-1.00AU	100	1651690000
HDC-C-HD-BM1.5AU	100	1651700000
HDC-C-HD-BM2.5AU	100	1651710000
Crimp contacts, female - silver		
HDC-C-HD-BM0.14-0.37AG	100	1651570000
HDC-C-HD-BM0.5AG	100	1651580000
HDC-C-HD-BM0.75-1.00AG	100	1601760000
HDC-C-HD-BM1.5AG	100	1651600000
HDC-C-HD-BM2.5AG	100	1651610000
Tools		
CTX CM 1.6/2.5	1	9018490000
REMOVAL TOOL HD	1	1866730000

Housing selection RockStar® IP65
Size 10



For additional housings, refer to chapter D for IP65

Hood

Plug housing, cable entry sideways



a	Version	Cover	b (mm)	Type	Order No.
M 32	w. thread		79	HDC 32B TSLU 1M32G	1788420000

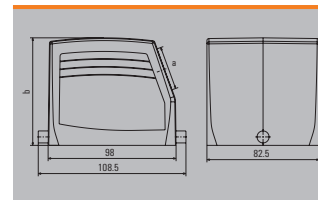

Base

Bulkhead housing



Version	Cover	b (mm)	Type	Order No.
End-locking		38	HDC 32B ALU	1219500000
End-locking	with cover	55	HDC 32B ADLU	1219800000

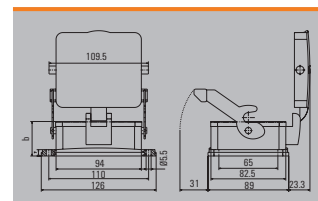

Base housing



a	Version	Cover	b (mm)	Type	Order No.
M 32	End-locking		79	HDC 32B SLU 2M32G	1788470000
M 32	End-locking	with cover	96	HDC 32B SDLU 2M32G	1788490000

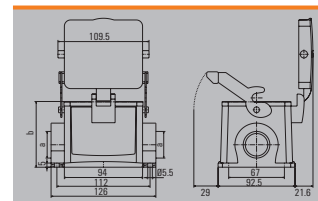

Coupling housing



a	Version	Cover	b (mm)	Type	Order No.
M 32	w. thread		83	HDC 32B KLU 1M32G	1788500000

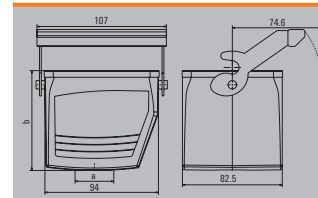

250 V, 10 A, size 12

128 + ⊕

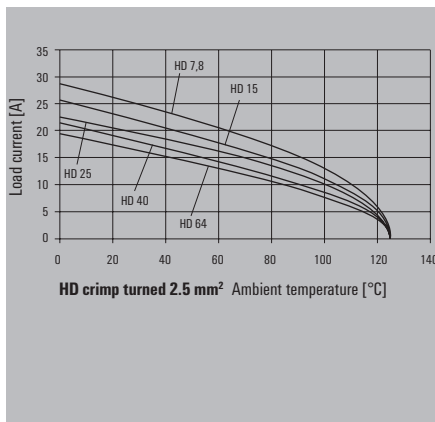
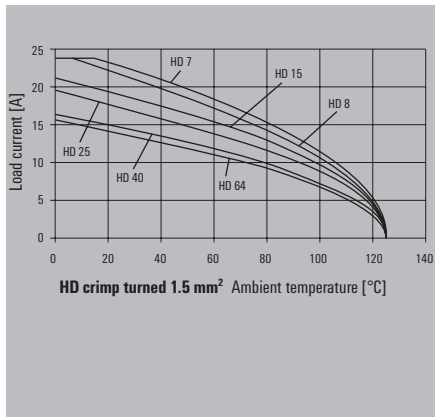

Installation cut-out

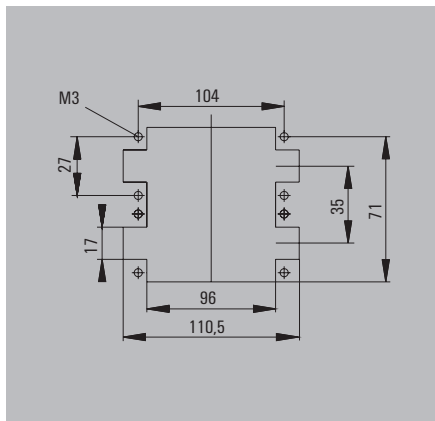

Male

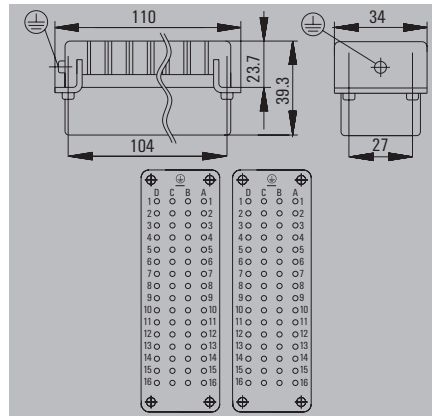

Ordering data

Type of connection	Type	Qty.	Order No.
Crimp connection	HDC HD 64 MC	1	1601720000

Please use this insert type doubled for size 12 (128-pole). We recommend the use of guide pins and sockets.

Accessories

Type	Qty.	Order No.
Crimp contacts, male - gold		
HDC-C-HD-SM0.14-0.37AU	100	1651620000
HDC-C-HD-SM0.5AU	100	1651630000
HDC-C-HD-SM0.75-1.00AU	100	1651640000
HDC-C-HD-SM1.5AU	100	1651650000
HDC-C-HD-SM2.5AU	100	1651660000
Crimp contacts, male - silver		
HDC-C-HD-SM0.14-0.37AG	100	1651520000
HDC-C-HD-SM0.5AG	100	1651530000
HDC-C-HD-SM0.75-1.00AG	100	1601750000
HDC-C-HD-SM1.5AG	100	1651550000
HDC-C-HD-SM2.5AG	100	1651560000
Tools		
CTX CM 1.6/2.5	1	9018490000
REMOVAL TOOL HD	1	1866730000

Female

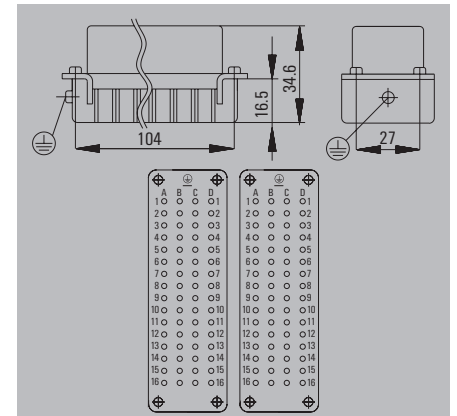

Ordering data

Type of connection	Type	Qty.	Order No.
Crimp connection	HDC HD 64 FC	1	1601740000

Please use this insert type doubled for size 12 (128-pole). We recommend the use of guide pins and sockets.

Accessories

Type	Qty.	Order No.
Crimp contacts, female - gold		
HDC-C-HD-BM0.14-0.37AU	100	1651670000
HDC-C-HD-BM0.5AU	100	1651680000
HDC-C-HD-BM0.75-1.00AU	100	1651690000
HDC-C-HD-BM1.5AU	100	1651700000
HDC-C-HD-BM2.5AU	100	1651710000
Crimp contacts, female - silver		
HDC-C-HD-BM0.14-0.37AG	100	1651570000
HDC-C-HD-BM0.5AG	100	1651580000
HDC-C-HD-BM0.75-1.00AG	100	1601760000
HDC-C-HD-BM1.5AG	100	1651600000
HDC-C-HD-BM2.5AG	100	1651610000
Tools		
CTX CM 1.6/2.5	1	9018490000
REMOVAL TOOL HD	1	1866730000

Housing selection RockStar® IP65
Size 12



For additional housings, refer to chapter D for IP65

Hood

Plug housing, cable entry sideways



a	Version	Cover	b (mm)	Type	Order No.
M 32	w. thread		94	HDC 48B TSLU 1M32G	1788320000
M 40	w. thread		94	HDC 48B TSLU 1M40G	1788310000
M 50	w. thread		94	HDC 48B TSLU 1M50G	1788330000

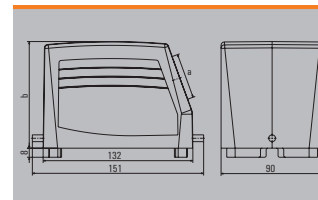

Plug housing, cable entry at top



a	Version	Cover	b (mm)	Type	Order No.
M 32	w. thread		94	HDC 48B TOLU 1M32G	1788350000
M 50	w. thread		94	HDC 48B TOLU 1M50G	1788330000

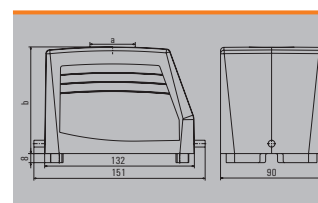

Base

Bulkhead housing



Version	Cover	b (mm)	Type	Order No.
End-locking	with cover	62	HDC 48B ADLU	1222900000

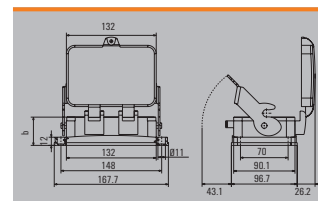

Base housing



a	Version	Cover	b (mm)	Type	Order No.
M 32	End-locking		100	HDC 48B SLU 2M32G	1788370000
M 32	End-locking	with cover	120	HDC 48B SDLU 2M32G	1788390000
M 40	End-locking		100	HDC 48B SLU 2M40G	1788360000

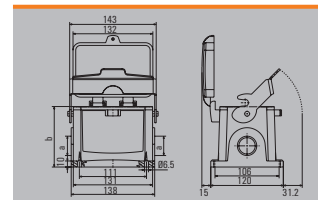

HDD series

Effective: These inserts are specially developed for crimp and fibre-optic contacts and provide a packing density of up to 216 poles.

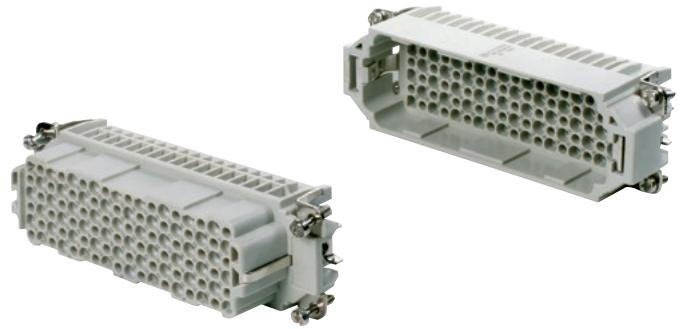













Technical data

Standards/approvals	
Standards	DIN EN 61984 DIN EN 60664-1
Approvals	UL/CSA
Inserts	
No. of poles	24, 42, 72, 108, 144, 216 + PE
Rated voltage	250 V
Rated voltage to UL/CSA	600 V
Rated current	10 A
Rated impulse withstand voltage	4 kV
Pollution severity	3
Insulation resistance	$\geq 10^{10} \Omega$
Material	Glass-fibre reinforced PC (in UL list and approved for railway applications)
Temperature range	-40 °C to +125 °C
Flammability to UL 94	V-0
Mechanical service life	
- Plugging cycles Ag - Surface	≥ 500
- Plugging cycles Au - Surface	≥ 500
Contact resistance	
Crimp connection	$\leq 4 \text{ m}\Omega$
Contacts/Material	
Sockets and plug-in contact	Copper alloy
Surface	Passivated silver, or gold-plated
Crimp connection	
- Flexible conductor connection	0.14 - 2.5 mm ² (AWG 26 - 14)
- Stripping length	8.0 mm
PE connection	
- Clamping range	0.5 - 2.5 mm ²
- solid/stranded	0.5 - 2.5 mm ² / 0.5 - 2.5 mm ²
- flexible/flexible with wire end ferrule, DIN 46228 pt. 1	0.5 - 2.5 mm ² / 0.5 - 2.5 mm ²
- AWG conductor	AWG 20 - 14
- Stripping length	10 mm
- Clamping torque	1.2 - 1.5 Nm
- Blade dimensions	SD 0.8 x 4 mm or PZ1

Note:

When used properly and as designated, the listed connectors may not be connected or disconnected if there is a live voltage or load!

Overview

		Size	Rated voltage	Rated current	No. of poles	Tension clamp connection	TOP connection	Screw conn. with wire guard spring	Crimp connection	PUSH IN connection	Page
		3	250 V	10 A	24 + ⊕				•		B.72
		4	250 V	10 A	42 + ⊕				•		B.74
		6	250 V	10 A	72 + ⊕				•		B.76
		8	250 V	10 A	108 + ⊕				•		B.78
		10	250 V	10 A	144 + ⊕				•		B.80
		12	250 V	10 A	216 + ⊕				•		B.82

250 V, 10 A, size 3

24 + ⊕

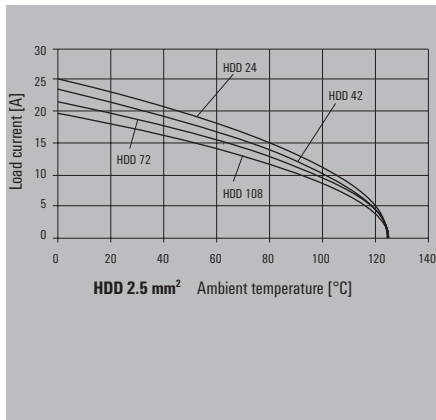
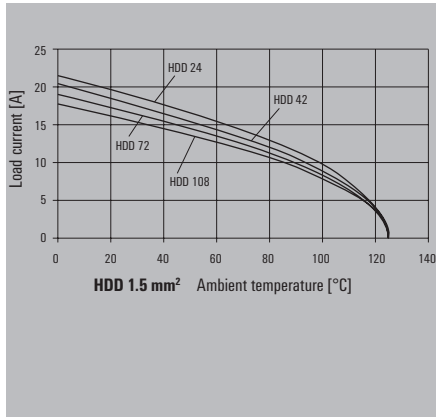

Installation cut-out

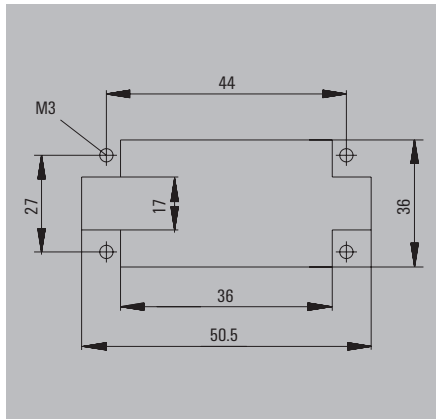

Male

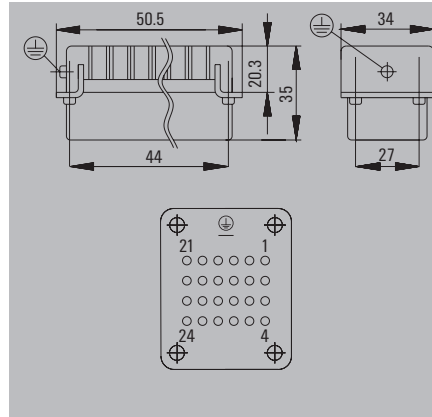
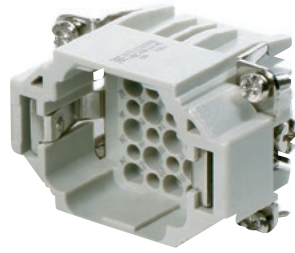

Ordering data

Type of connection	Type	Qty.	Order No.
Crimp connection	HDC HDD 24 MC	1	1651150000

Accessories

Type	Qty.	Order No.
Crimp contacts, male - gold		
HDC-C-HD-SM0.14-0.37AU	100	1651620000
HDC-C-HD-SM0.5AU	100	1651630000
HDC-C-HD-SM0.75-1.00AU	100	1651640000
HDC-C-HD-SM1.5AU	100	1651650000
HDC-C-HD-SM2.5AU	100	1651660000
Crimp contacts, male - silver		
HDC-C-HD-SM0.14-0.37AG	100	1651520000
HDC-C-HD-SM0.5AG	100	1651530000
HDC-C-HD-SM0.75-1.00AG	100	1601750000
HDC-C-HD-SM1.5AG	100	1651550000
HDC-C-HD-SM2.5AG	100	1651560000
Tools		
CTX CM 1.6/2.5	1	9018490000
REMOVAL TOOL HD	1	1866730000

Female

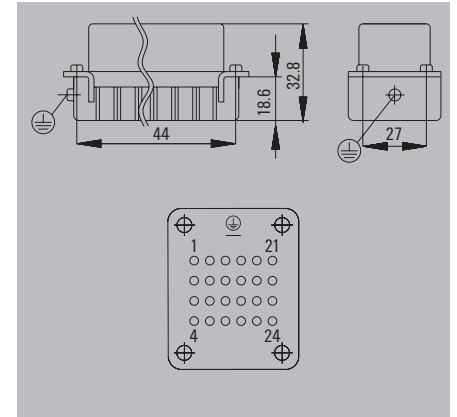

Ordering data

Type of connection	Type	Qty.	Order No.
Crimp connection	HDC HDD 24 FC	1	1651160000

Accessories

Type	Qty.	Order No.
Crimp contacts, female - gold		
HDC-C-HD-BM0.14-0.37AU	100	1651670000
HDC-C-HD-BM0.5AU	100	1651680000
HDC-C-HD-BM0.75-1.00AU	100	1651690000
HDC-C-HD-BM1.5AU	100	1651700000
HDC-C-HD-BM2.5AU	100	1651710000
Crimp contacts, female - silver		
HDC-C-HD-BM0.14-0.37AG	100	1651570000
HDC-C-HD-BM0.5AG	100	1651580000
HDC-C-HD-BM0.75-1.00AG	100	1601760000
HDC-C-HD-BM1.5AG	100	1651600000
HDC-C-HD-BM2.5AG	100	1651610000
Tools		
CTX CM 1.6/2.5	1	9018490000
REMOVAL TOOL HD	1	1866730000

Housing selection RockStar® IP65
Size 3



For additional housings, refer to
Chapter D for IP65 / Chapter E for IP65 EMC /
Chapter F for IP68 EMC

Hood

Plug housing, cable entry sideways



a	Version	Cover	b (mm)	Type	Order No.
M 20	w. thread		52	HDC 06B TSLU 1M20G	1788100000
M 25	w. thread		52	HDC 06B TSLU 1M25G	1788090000
M 25	w. thread		72	HDC 16D TSLU 1M25G	1787480000

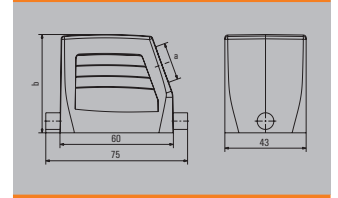

Plug housing, cable entry at top



a	Version	Cover	b (mm)	Type	Order No.
M 20	w. thread		52	HDC 06B TOLU 1M20G	1788120000
M 25	w. thread		52	HDC 06B TOLU 1M25G	1788110000
M 25	w. thread		72	HDC 16D TOLU 1M25G	1787500000
M 32	w. thread		72	HDC 16D TOLU 1M32G	1787490000

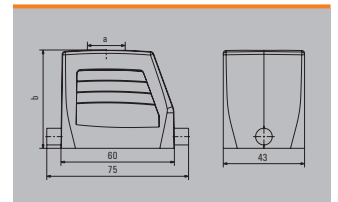

Cover



Version	Type	Order No.
For hoods	HDC 06B DMDL 1LB	1665210000
For hoods	HDC 06B DMDL 1LB N	2559730000

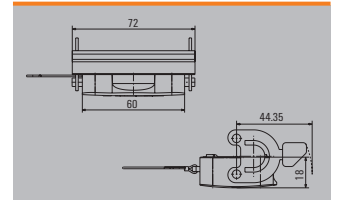

Note: N = Plastic locking lever with stainless steel inlay

Base

Bulkhead housing



Version	Cover	b (mm)	Type	Order No.
End-locking	without cover	29.3	HDC 06B ALU	1202100000
End-locking	without cover	29.3	HDC 06B ALU N	2488560000
End-locking	with cover	29.3	HDC 06B ADLU	1202500000
End-locking	with cover	29.3	HDC 06B ADLU N	2559320000

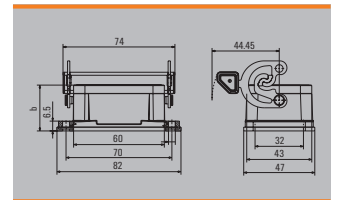

Note: N = Plastic locking lever with stainless steel inlay

Base housing



a	Version	Cover	b (mm)	Type	Order No.
M 20	End-locking		54	HDC 06B SLU 1M20G N	2637080000
M 20	End-locking	with cover	54	HDC 06B SDLU 1M20G N	2560720000
M 20	End-locking	with cover	54	HDC 06B SLU 2M20G	1788140000
M 20	End-locking	with cover	54	HDC 06B SDLU 2M20G	1788170000
M 25	End-locking		54	HDC 06B SLU 2M25G	1788130000
M 25	End-locking	without cover	54	HDC 06B SLU 2M25G N	2560860000
M 25	End-locking	with cover	54	HDC 06B SDLU 2M25G	1788160000
M 25	End-locking	with cover	54	HDC 06B SDLU 2M25G N	2560830000

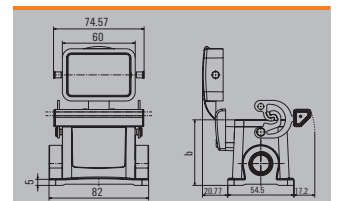

Note: N = Plastic locking lever with stainless steel inlay

Cover



Version	Type	Order No.
For bases	HDC 06B DDDL 2B0	1665200000

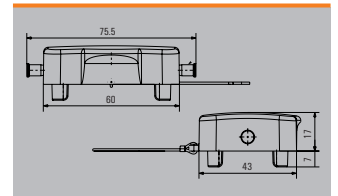

250 V, 10 A, size 4

42 + ⊕

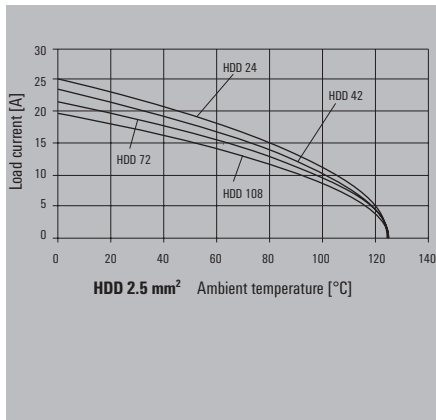
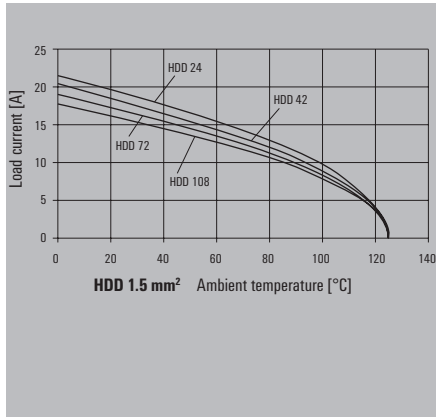

Installation cut-out

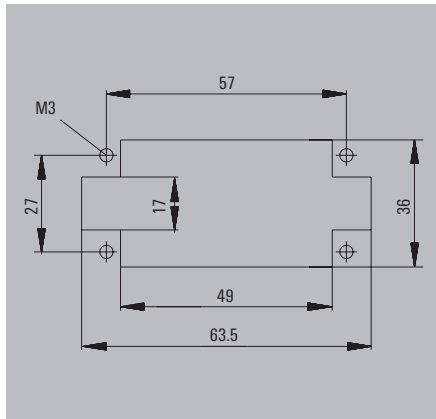

Male

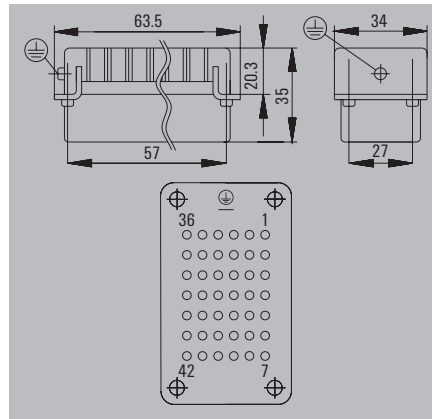
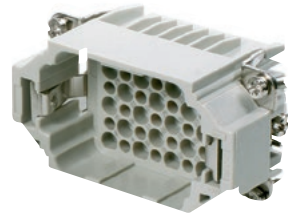

Ordering data

Type of connection	Type	Qty.	Order No.
Crimp connection	HDC HDD 42 MC	1	1651170000

Accessories

Type	Qty.	Order No.
Crimp contacts, male - gold		
HDC-C-HD-SM0.14-0.37AU	100	1651620000
HDC-C-HD-SM0.5AU	100	1651630000
HDC-C-HD-SM0.75-1.00AU	100	1651640000
HDC-C-HD-SM1.5AU	100	1651650000
HDC-C-HD-SM2.5AU	100	1651660000
Crimp contacts, male - silver		
HDC-C-HD-SM0.14-0.37AG	100	1651520000
HDC-C-HD-SM0.5AG	100	1651530000
HDC-C-HD-SM0.75-1.00AG	100	1601750000
HDC-C-HD-SM1.5AG	100	1651550000
HDC-C-HD-SM2.5AG	100	1651560000
Tools		
CTX CM 1.6/2.5	1	9018490000
REMOVAL TOOL HD	1	1866730000

Female

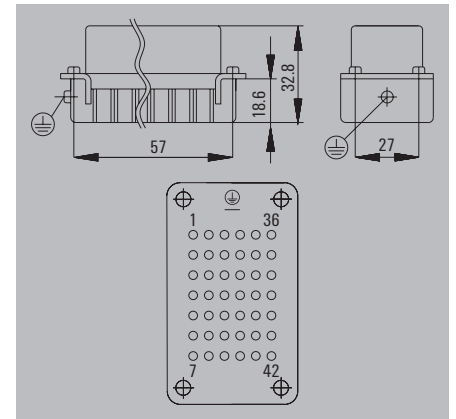

Ordering data

Type of connection	Type	Qty.	Order No.
Crimp connection	HDC HDD 42 FC	1	1651180000

Accessories

Type	Qty.	Order No.
Crimp contacts, female - gold		
HDC-C-HD-BM0.14-0.37AU	100	1651670000
HDC-C-HD-BM0.5AU	100	1651680000
HDC-C-HD-BM0.75-1.00AU	100	1651690000
HDC-C-HD-BM1.5AU	100	1651700000
HDC-C-HD-BM2.5AU	100	1651710000
Crimp contacts, female - silver		
HDC-C-HD-BM0.14-0.37AG	100	1651570000
HDC-C-HD-BM0.5AG	100	1651580000
HDC-C-HD-BM0.75-1.00AG	100	1601760000
HDC-C-HD-BM1.5AG	100	1651600000
HDC-C-HD-BM2.5AG	100	1651610000
Tools		
CTX CM 1.6/2.5	1	9018490000
REMOVAL TOOL HD	1	1866730000

Housing selection RockStar® IP65
Size 4



For additional housings, refer to
Chapter D for IP65 / Chapter E for IP65 EMC /
Chapter F for IP68 EMC

Hood

Plug housing, cable entry sideways



a	Version	Cover	b (mm)	Type	Order No.
M 20	w. thread		52	HDC 10B TSBU 1M20G	1787560000
M 25	w. thread		52	HDC 10B TSBU 1M25G	1787550000
M 25	w. thread		72	HDC 24D TSBU 1M25G	1787240000
M 32	w. thread		72	HDC 24D TSBU 1M32G	1787230000

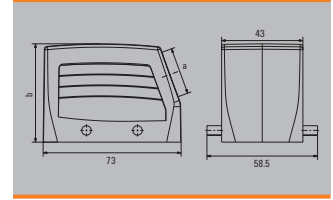

Plug housing, cable entry at top



a	Version	Cover	b (mm)	Type	Order No.
M 20	w. thread		52	HDC 10B TOBU 1M20G	1787600000
M 25	w. thread		52	HDC 10B TOBU 1M25G	1787590000
M 25	w. thread		72	HDC 24D TOBU 1M25G	1787300000
M 32	w. thread		72	HDC 24D TOBU 1M32G	1787290000

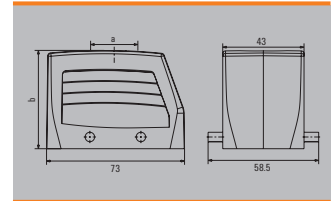

Cover



Version	Type	Order No.
For hoods	HDC 10B DMDQ 2QB	1665240000
For hoods	HDC 10B DMDQ 2QB N	2559740000

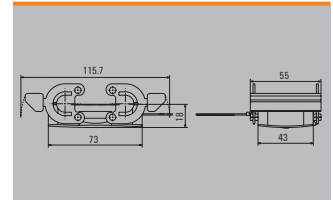

Note: N = Plastic locking lever with stainless steel inlay

Base

Bulkhead housing



Version	Cover	b (mm)	Type	Order No.
Side-locking		29.5	HDC 10B ABU	1205000000
Side-locking		29.5	HDC 10B ABU N	2488580000

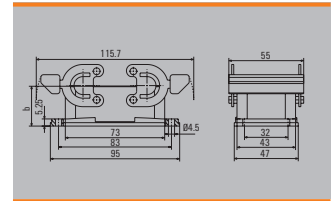

Note: N = Plastic locking lever with stainless steel inlay

Base housing



a	Version	Cover	b (mm)	Type	Order No.
M 20	Side-locking		57	HDC 10B SBU 1M20G N	2560880000
M 20	Side-locking		57	HDC 10B SBU 2M20G	1787640000
M 20	Side-locking		57	HDC 10B SBU 2M20G N	2560890000
M 25	Side-locking		57	HDC 10B SBU 1M25G N	2560900000
M 25	Side-locking		57	HDC 10B SBU 2M25G	1787630000
M 25	Side-locking		57	HDC 10B SBU 2M25G N	2560910000

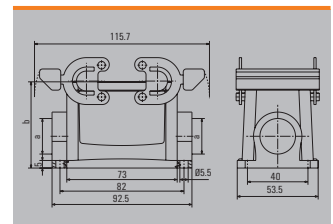

Note: N = Plastic locking lever with stainless steel inlay

Coupling housing



a	Version	Cover	b (mm)	Type	Order No.
M 20	w. thread		54.65	HDC 10B KBU 1M20G	1787720000
M 20	w. thread		54.65	HDC 10B KBU 1M20G N	2559860000

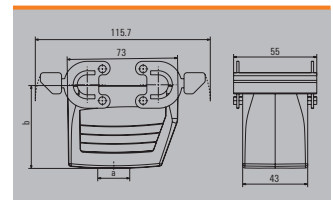

Note: N = Plastic locking lever with stainless steel inlay

Cover



Version	Type	Order No.
For bases	HDC 10B DDDQ 4B0	1665230000

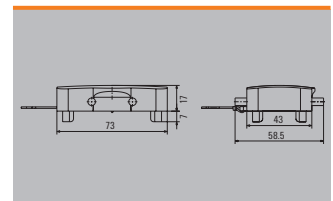

250 V, 10 A, size 6

72 + ⊕

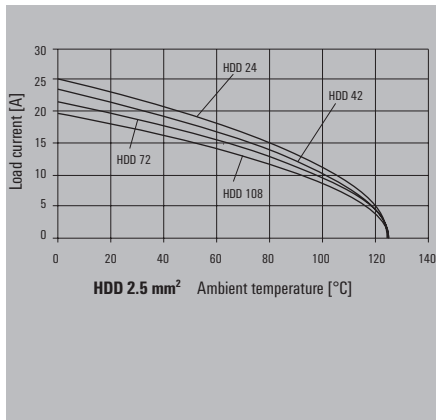
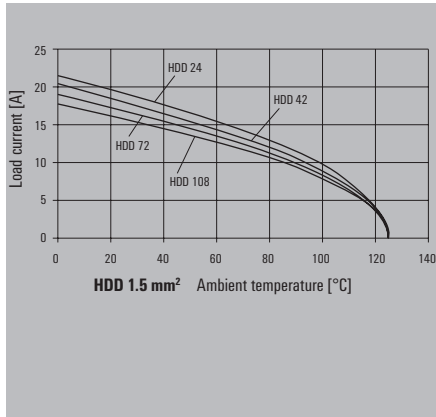

Installation cut-out

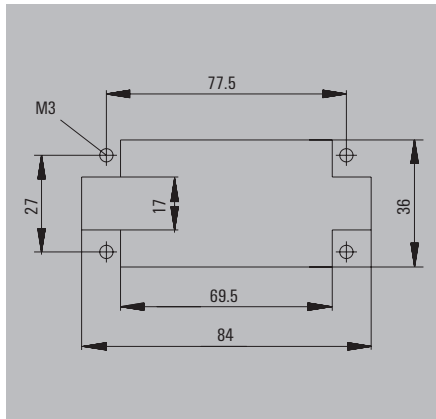

Male

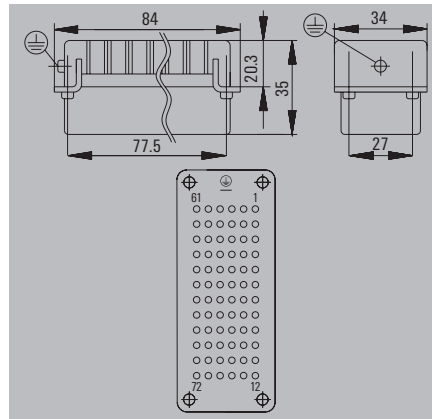
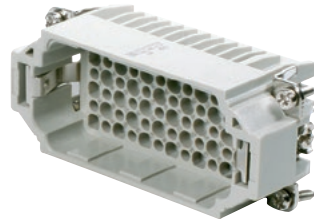

Ordering data

Type of connection	Type	Qty.	Order No.
Crimp connection	HDC HDD 72 MC	1	1651190000

We recommend the use of guide pins and sockets.

Accessories

Type	Qty.	Order No.
Crimp contacts, male - gold		
HDC-C-HD-SM0.14-0.37AU	100	1651620000
HDC-C-HD-SM0.5AU	100	1651630000
HDC-C-HD-SM0.75-1.00AU	100	1651640000
HDC-C-HD-SM1.5AU	100	1651650000
HDC-C-HD-SM2.5AU	100	1651660000
Crimp contacts, male - silver		
HDC-C-HD-SM0.14-0.37AG	100	1651520000
HDC-C-HD-SM0.5AG	100	1651530000
HDC-C-HD-SM0.75-1.00AG	100	1601750000
HDC-C-HD-SM1.5AG	100	1651550000
HDC-C-HD-SM2.5AG	100	1651560000
Tools		
CTX CM 1.6/2.5	1	9018490000
REMOVAL TOOL HD	1	1866730000

Female

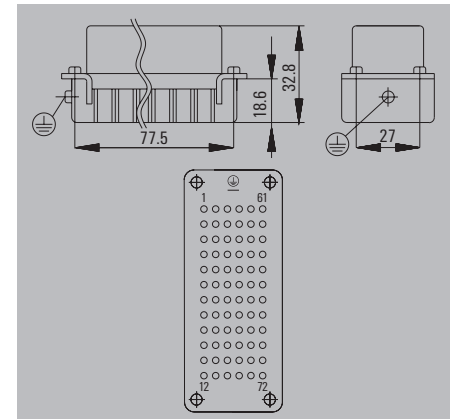
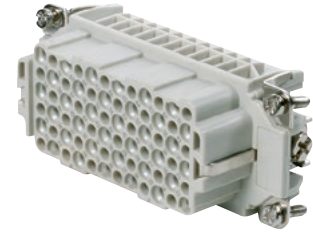

Ordering data

Type of connection	Type	Qty.	Order No.
Crimp connection	HDC HDD 72 FC	1	1651200000

We recommend the use of guide pins and sockets.

Accessories

Type	Qty.	Order No.
Crimp contacts, female - gold		
HDC-C-HD-BM0.14-0.37AU	100	1651670000
HDC-C-HD-BM0.5AU	100	1651680000
HDC-C-HD-BM0.75-1.00AU	100	1651690000
HDC-C-HD-BM1.5AU	100	1651700000
HDC-C-HD-BM2.5AU	100	1651710000
Crimp contacts, female - silver		
HDC-C-HD-BM0.14-0.37AG	100	1651570000
HDC-C-HD-BM0.5AG	100	1651580000
HDC-C-HD-BM0.75-1.00AG	100	1601760000
HDC-C-HD-BM1.5AG	100	1651600000
HDC-C-HD-BM2.5AG	100	1651610000
Tools		
CTX CM 1.6/2.5	1	9018490000
REMOVAL TOOL HD	1	1866730000

Housing selection RockStar® IP65
Size 6



For additional housings, refer to
Chapter D for IP65 / Chapter E for IP65 EMC /
Chapter F for IP68 EMC

Hood

Plug housing, cable entry sideways



a	Version	Cover	b (mm)	Type	Order No.
M 25	w. thread		61	HDC 16B TSBU 1M25G	1788180000
M 25	w. thread		76	HDC 40D TSBU 1M25G	1787010000
M 32	w. thread		76	HDC 40D TSBU 1M32G	1787000000

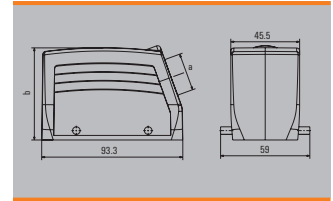

Plug housing, cable entry at top



a	Version	Cover	b (mm)	Type	Order No.
M 25	w. thread		61	HDC 16B TOBU 1M25G	1788210000
M 25	w. thread		76	HDC 40D TOBU 1M25G	1787070000
M 32	w. thread		76	HDC 40D TOBU 1M32G	1787060000

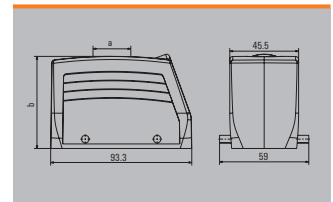

Cover



Version	Type	Order No.
For hoods	HDC 16B DMDQ 2QB	1665270000

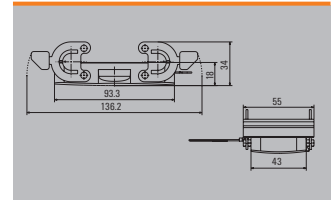

Base

Bulkhead housing



Version	Cover	b (mm)	Type	Order No.
Side-locking		29	HDC 16B ABU	1208600000
Side-locking		29	HDC 16B ABU N	2488590000

Note: N = Plastic locking lever with stainless steel inlay

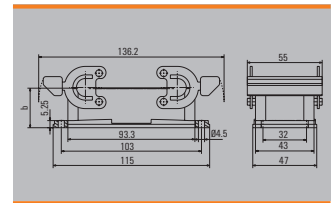

Base housing



a	Version	Cover	b (mm)	Type	Order No.
M 25	Side-locking		64	HDC 16B SBU 1M25G N	2560740000
M 25	Side-locking		64	HDC 16B SBU 2M25G	1788240000
M 25	Side-locking		64	HDC 16B SBU 2M25G N	2560930000
M 25	Side-locking		84	HDC 40D SBU 2M25G	1787120000
PG 21	Side-locking		84	HDC 40D SBU 1M32G N	2561030000
M 32	Side-locking		84	HDC 40D SBU 2M32G	1787110000

Note: N = Plastic locking lever with stainless steel inlay

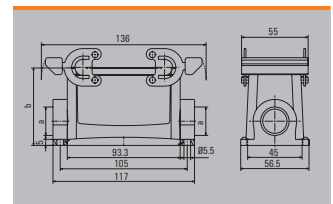

Coupling housing



a	Version	Cover	b (mm)	Type	Order No.
M 25	w. thread		78.6	HDC 40D KBU 1M25G	1787200000
PG 29	w. thread		79	HDC 40D KBU 1M25G N	2559890000
M 32	w. thread		78.6	HDC 40D KBU 1M32G	1787190000
PG 29	w. thread		79	HDC 40D KBU 1M32G N	2559900000
PG 29	w. thread		79	HDC 40D KBU 2M32G N	2545510000

Note: N = Plastic locking lever with stainless steel inlay

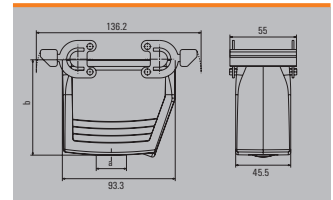

Cover



Version	Type	Order No.
For bases	HDC 16B DDDQ 480	1665260000

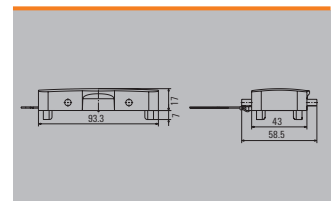

250 V, 10 A, size 8

108 + ⊕

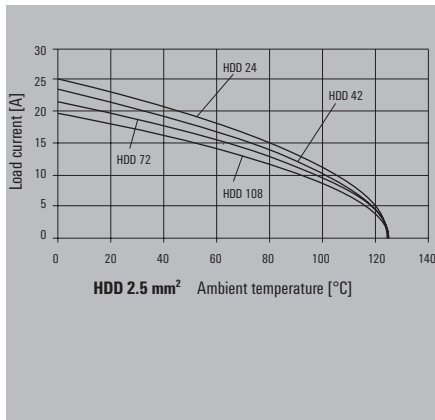
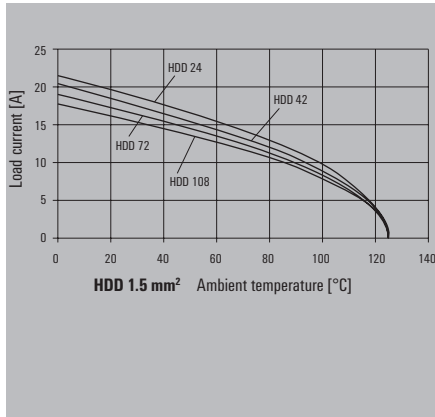

Installation cut-out

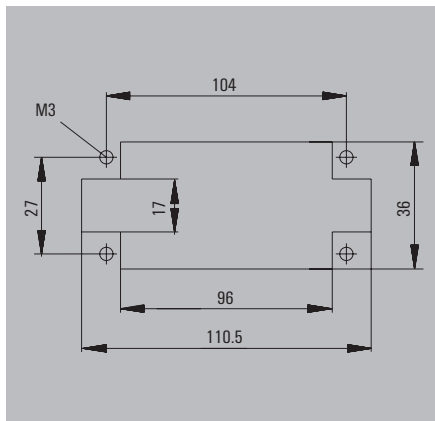

Male

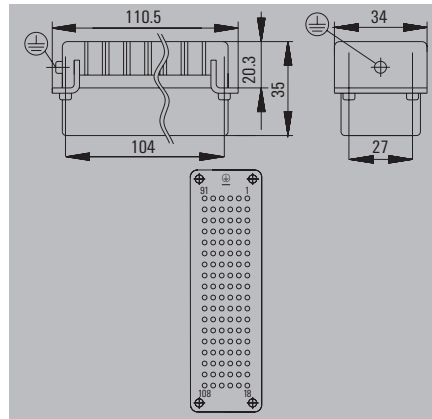

Ordering data

Type of connection	Type	Qty.	Order No.
Crimp connection	HDC HDD 108 MC	1	1651210000

We recommend the use of guide pins and sockets.

Accessories

Type	Qty.	Order No.
Crimp contacts, male - gold		
HDC-C-HD-SM0.14-0.37AU	100	1651620000
HDC-C-HD-SM0.5AU	100	1651630000
HDC-C-HD-SM0.75-1.00AU	100	1651640000
HDC-C-HD-SM1.5AU	100	1651650000
HDC-C-HD-SM2.5AU	100	1651660000
Crimp contacts, male - silver		
HDC-C-HD-SM0.14-0.37AG	100	1651520000
HDC-C-HD-SM0.5AG	100	1651530000
HDC-C-HD-SM0.75-1.00AG	100	1601750000
HDC-C-HD-SM1.5AG	100	1651550000
HDC-C-HD-SM2.5AG	100	1651560000
Tools		
CTX CM 1.6/2.5	1	9018490000
REMOVAL TOOL HD	1	1866730000

Female

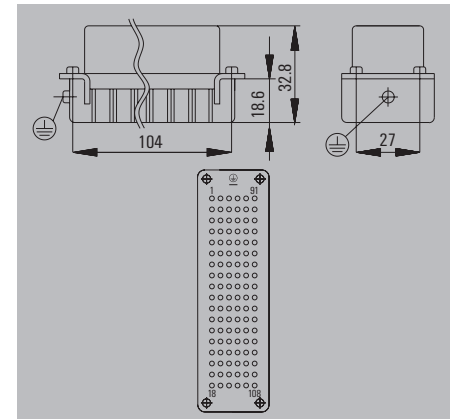

Ordering data

Type of connection	Type	Qty.	Order No.
Crimp connection	HDC HDD 108 FC	1	1651220000

We recommend the use of guide pins and sockets.

Accessories

Type	Qty.	Order No.
Crimp contacts, female - gold		
HDC-C-HD-BM0.14-0.37AU	100	1651670000
HDC-C-HD-BM0.5AU	100	1651680000
HDC-C-HD-BM0.75-1.00AU	100	1651690000
HDC-C-HD-BM1.5AU	100	1651700000
HDC-C-HD-BM2.5AU	100	1651710000
Crimp contacts, female - silver		
HDC-C-HD-BM0.14-0.37AG	100	1651570000
HDC-C-HD-BM0.5AG	100	1651580000
HDC-C-HD-BM0.75-1.00AG	100	1601760000
HDC-C-HD-BM1.5AG	100	1651600000
HDC-C-HD-BM2.5AG	100	1651610000
Tools		
CTX CM 1.6/2.5	1	9018490000
REMOVAL TOOL HD	1	1866730000

Housing selection RockStar® IP65
Size 8



For additional housings, refer to
Chapter D for IP65 / Chapter E for IP65 EMC /
Chapter F for IP68 EMC

Hood

Plug housing, cable entry sideways



a	Version	Cover	b (mm)	Type	Order No.
M 25	w. thread		62.58	HDC 24B TSBU 1M25G	1787760000
M 25	w. thread		76	HDC 64D TSBU 1M25G	1786780000
M 32	w. thread		62.58	HDC 24B TSBU 1M32G	1787750000
M 32	w. thread		76	HDC 64D TSBU 1M32G	1786770000

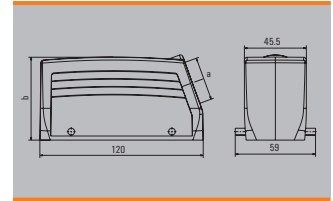

Plug housing, cable entry at top



a	Version	Cover	b (mm)	Type	Order No.
M 25	w. thread		62.58	HDC 24B TOBU 1M25G	1787820000
M 32	w. thread		62.58	HDC 24B TOBU 1M32G	1787810000
M 32	w. thread		76	HDC 64D TOBU 1M32G	1786830000

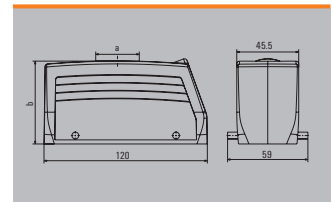

Cover



Version	Type	Order No.
For hoods	HDC 24B DMDQ 2QB	1665640000
For hoods	HDC 24B DMDQ 2QB N	2559760000

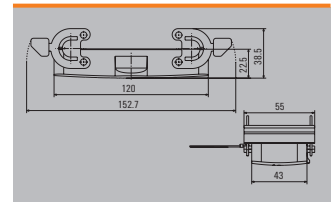

Note: N = Plastic locking lever with stainless steel inlay

Base

Bulkhead housing



Version	Cover	b (mm)	Type	Order No.
Side-locking		29.5	HDC 24B ABU	1212400000
Side-locking		29.5	HDC 24B ABU N	2488600000

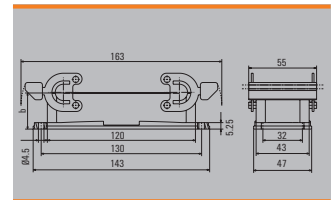

Note: N = Plastic locking lever with stainless steel inlay

Base housing



a	Version	Cover	b (mm)	Type	Order No.
M 25	Side-locking		64	HDC 24B SBU 2M25G	1787870000
M 25	Side-locking		64	HDC 24B SBU 2M25G N	2560970000
M 25	Side-locking		84	HDC 64D SBU 2M25G	1786890000
M 32	Side-locking		84	HDC 64D SBU 2M25G N	2561060000
M 32	Side-locking		84	HDC 64D SBU 1M32G N	2561050000
M 32	Side-locking		84	HDC 64D SBU 2M32G	1786880000

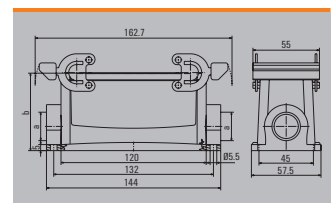

Note: N = Plastic locking lever with stainless steel inlay

Coupling housing



a	Version	Cover	b (mm)	Type	Order No.
M 25	w. thread		65	HDC 24B KBU 1M25G	1787920000
M 25	w. thread		65	HDC 24B KBU 1M25G N	2559870000
M 32	w. thread		65	HDC 24B KBU 2M32G N	2559880000
M 32	w. thread		79	HDC 64D KBU 1M32G	1786960000
M 32	w. thread		79	HDC 64D KBU 1M32G N	2559910000

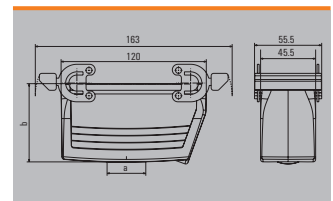

Note: N = Plastic locking lever with stainless steel inlay

Cover



Version	Type	Order No.
For bases	HDC 24B DDDQ 4B0	1665630000

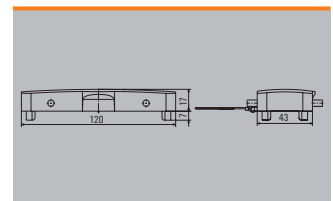

250 V, 10 A, size 10

144 + ⊕

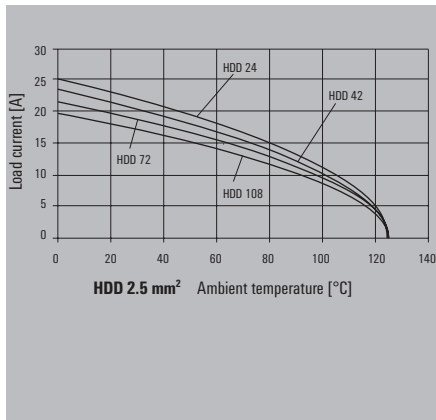
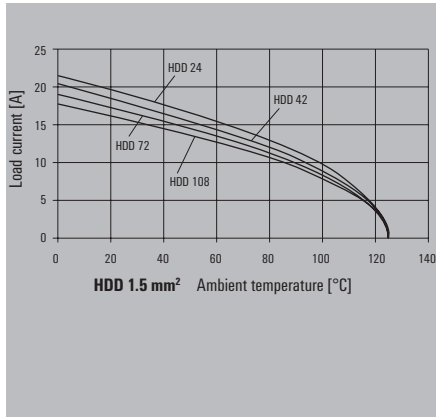

Installation cut-out

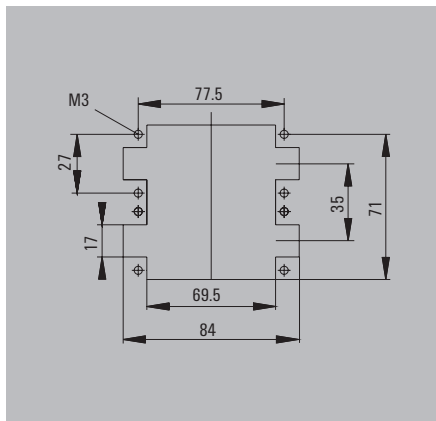

Male

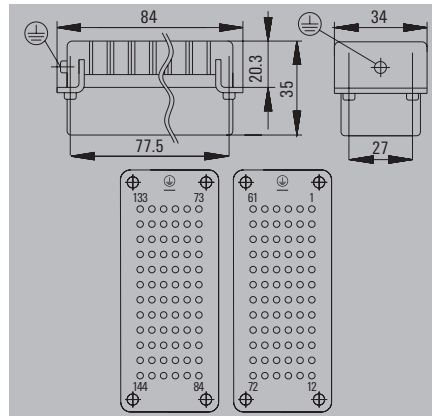

Ordering data

Type of connection	Type	Qty.	Order No.
Crimp connection	HDC HDD 72 MC	1	1651190000
Crimp connection	HDC HDD 72 MC 73-144	1	1651240000

We recommend the use of guide pins and sockets.

Accessories

Type	Qty.	Order No.
Crimp contacts, male - gold		
HDC-C-HD-SM0.14-0.37AU	100	1651620000
HDC-C-HD-SM0.5AU	100	1651630000
HDC-C-HD-SM0.75-1.00AU	100	1651640000
HDC-C-HD-SM1.5AU	100	1651650000
HDC-C-HD-SM2.5AU	100	1651660000
Crimp contacts, male - silver		
HDC-C-HD-SM0.14-0.37AG	100	1651520000
HDC-C-HD-SM0.5AG	100	1651530000
HDC-C-HD-SM0.75-1.00AG	100	1601750000
HDC-C-HD-SM1.5AG	100	1651550000
HDC-C-HD-SM2.5AG	100	1651560000
Tools		
CTX CM 1.6/2.5	1	9018490000
REMOVAL TOOL HD	1	1866730000

Female

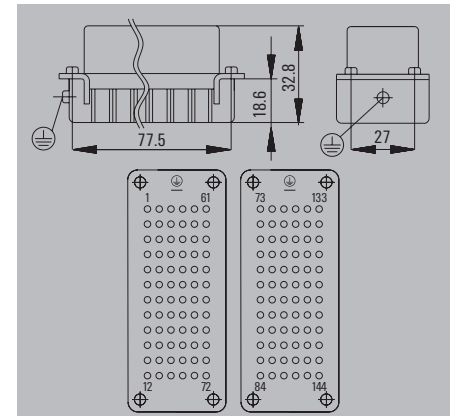

Ordering data

Type of connection	Type	Qty.	Order No.
Crimp connection	HDC HDD 72 FC	1	1651200000
Crimp connection	HDC HDD 72 FC 73-144	1	1651260000

We recommend the use of guide pins and sockets.

Accessories

Type	Qty.	Order No.
Crimp contacts, female - gold		
HDC-C-HD-BM0.14-0.37AU	100	1651670000
HDC-C-HD-BM0.5AU	100	1651680000
HDC-C-HD-BM0.75-1.00AU	100	1651690000
HDC-C-HD-BM1.5AU	100	1651700000
HDC-C-HD-BM2.5AU	100	1651710000
Crimp contacts, female - silver		
HDC-C-HD-BM0.14-0.37AG	100	1651570000
HDC-C-HD-BM0.5AG	100	1651580000
HDC-C-HD-BM0.75-1.00AG	100	1601760000
HDC-C-HD-BM1.5AG	100	1651600000
HDC-C-HD-BM2.5AG	100	1651610000
Tools		
CTX CM 1.6/2.5	1	9018490000
REMOVAL TOOL HD	1	1866730000

Housing selection RockStar® IP65
Size 10



For additional housings, refer to chapter D for IP65

Hood

Plug housing, cable entry sideways



a	Version	Cover	b (mm)	Type	Order No.
M 32	w. thread		79	HDC 32B TSLU 1M32G	1788420000

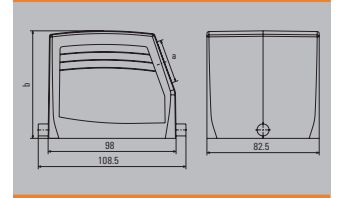

Base

Bulkhead housing



Version	Cover	b (mm)	Type	Order No.
End-locking		38	HDC 32B ALU	1219500000
End-locking	with cover	55	HDC 32B ADLU	1219800000

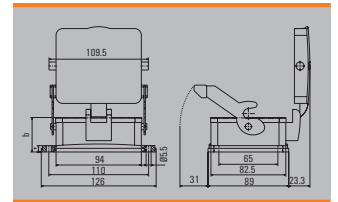

Base housing



a	Version	Cover	b (mm)	Type	Order No.
M 32	End-locking		79	HDC 32B SLU 2M32G	1788470000
M 32	End-locking	with cover	96	HDC 32B SDLU 2M32G	1788490000

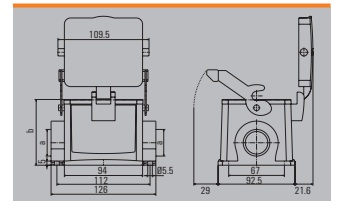

Coupling housing



a	Version	Cover	b (mm)	Type	Order No.
M 32	w. thread		83	HDC 32B KLU 1M32G	1788500000

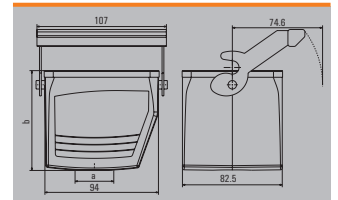

250 V, 10 A, size 12

216 + ⊕

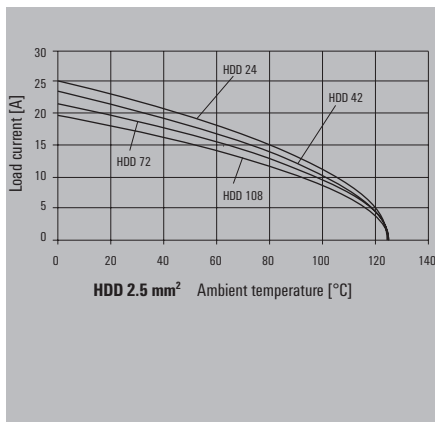
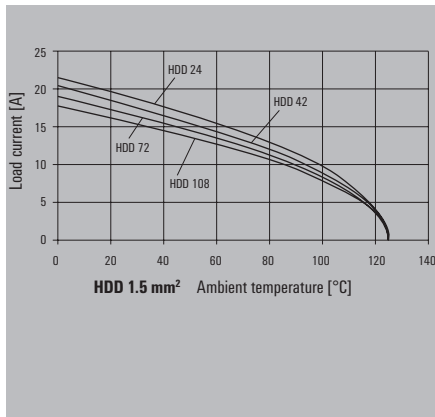

Installation cut-out

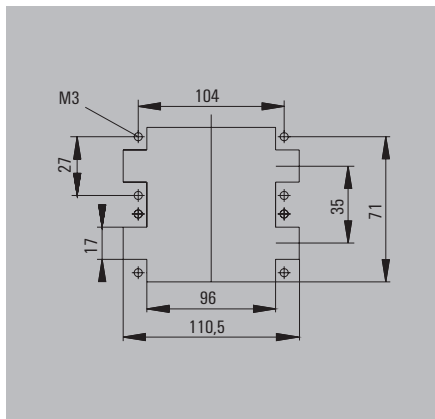

Male

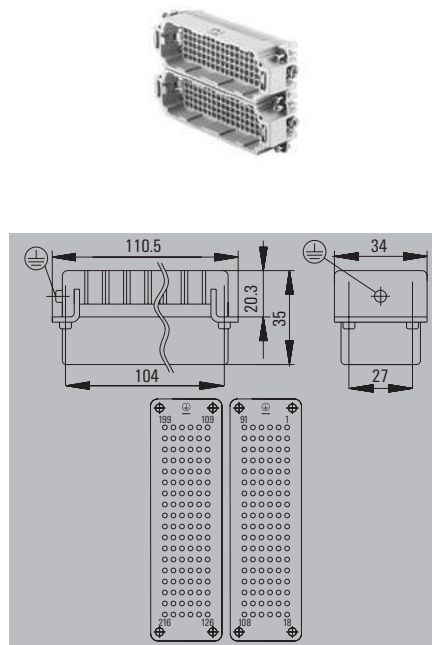

Ordering data

Type of connection	Type	Qty.	Order No.
Crimp connection	HDC HDD 108 MC	1	1651210000
Crimp connection	HDC HDD 108 MC 109-216	1	1651280000

We recommend the use of guide pins and sockets.

Accessories

Type	Qty.	Order No.
Crimp contacts, male - gold		
HDC-C-HD-SM0.14-0.37AU	100	1651620000
HDC-C-HD-SM0.5AU	100	1651630000
HDC-C-HD-SM0.75-1.00AU	100	1651640000
HDC-C-HD-SM1.5AU	100	1651650000
HDC-C-HD-SM2.5AU	100	1651660000
Crimp contacts, male - silver		
HDC-C-HD-SM0.14-0.37AG	100	1651520000
HDC-C-HD-SM0.5AG	100	1651530000
HDC-C-HD-SM0.75-1.00AG	100	1601750000
HDC-C-HD-SM1.5AG	100	1651550000
HDC-C-HD-SM2.5AG	100	1651560000
Tools		
CTX CM 1.6/2.5	1	9018490000
REMOVAL TOOL HD	1	1866730000

Female

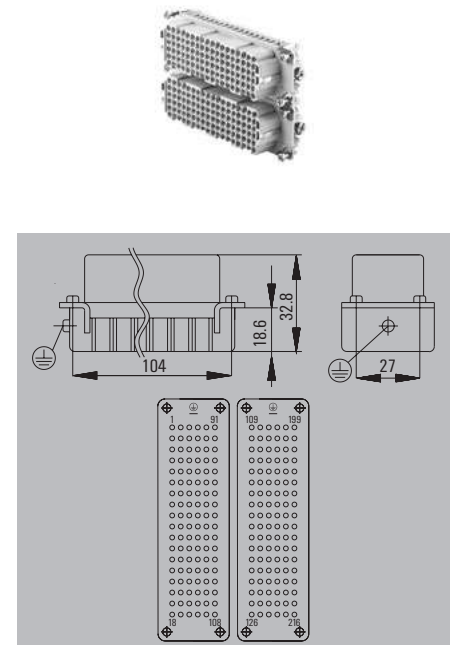

Ordering data

Type of connection	Type	Qty.	Order No.
Crimp connection	HDC HDD 108 FC	1	1651220000
Crimp connection	HDC HDD 108 FC 109-216	1	1651300000

We recommend the use of guide pins and sockets.

Accessories

Type	Qty.	Order No.
Crimp contacts, female - gold		
HDC-C-HD-BM0.14-0.37AU	100	1651670000
HDC-C-HD-BM0.5AU	100	1651680000
HDC-C-HD-BM0.75-1.00AU	100	1651690000
HDC-C-HD-BM1.5AU	100	1651700000
HDC-C-HD-BM2.5AU	100	1651710000
Crimp contacts, female - silver		
HDC-C-HD-BM0.14-0.37AG	100	1651570000
HDC-C-HD-BM0.5AG	100	1651580000
HDC-C-HD-BM0.75-1.00AG	100	1601760000
HDC-C-HD-BM1.5AG	100	1651600000
HDC-C-HD-BM2.5AG	100	1651610000
Tools		
CTX CM 1.6/2.5	1	9018490000
REMOVAL TOOL HD	1	1866730000

Housing selection RockStar® IP65 Size 12



For additional housings, refer to
chapter D for IP65

Hood

Plug housing, cable entry sideways



a	Version	Cover	b (mm)	Type	Order No.
M 32	w. thread		94	HDC 48B TSLU 1M32G	1788320000
M 40	w. thread		94	HDC 48B TSLU 1M40G	1788310000
M 50	w. thread		94	HDC 48B TSLU 1M50G	1788330000

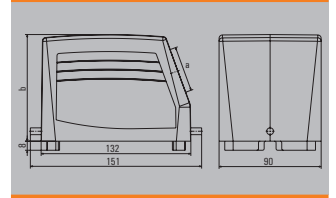

Plug housing, cable entry at top



a	Version	Cover	b (mm)	Type	Order No.
M 32	w. thread		94	HDC 48B TOLU 1M32G	1788350000
M 50	w. thread		94	HDC 48B TOLU 1M50G	1788330000

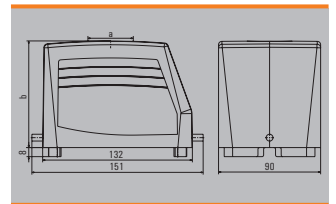

Base

Bulkhead housing



Version	Cover	b (mm)	Type	Order No.
End-locking	with cover	62	HDC 48B ADLU	1222900000

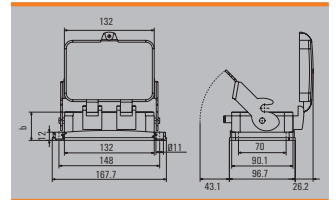

Base housing



a	Version	Cover	b (mm)	Type	Order No.
M 32	End-locking		100	HDC 48B SLU 2M32G	1788370000
M 32	End-locking	with cover	120	HDC 48B SDLU 2M32G	1788390000
M 40	End-locking		100	HDC 48B SLU 2M40G	1788360000

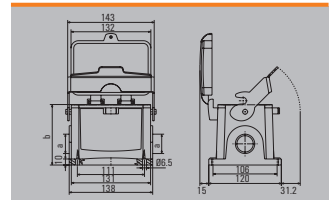

HVE series

Weidmüller high-voltage inserts are equipped with lagging contacts. This results in more security during real operations.

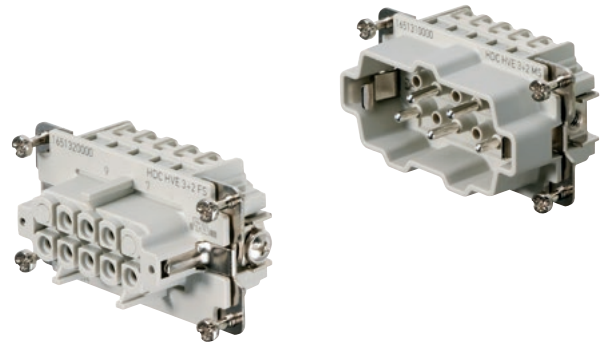

Technical data







Standards/approvals	
Standards	DIN EN 61984 DIN EN 60664-1
Approvals	UL/CSA**
Inserts	
No. of poles	3 + 2, 6 + 2, 10 + 2
Rated voltage	830 V
Rated voltage to UL/CSA	600 V
Rated current	20 A
Rated impulse withstand voltage	8 kV
Pollution severity	3 (1000 V / 8 kV / 2)
Insulation resistance	≥ 1010 Ω
Material	Glass-fibre reinforced PC (in UL list and approved for railway applications)
Temperature range	-40 °C to +125 °C
Flammability to UL 94	V-0
Mechanical service life	
- Plugging cycles Ag - Surface	≥ 500
Contact resistance	≤ 2 mΩ
Contacts/Material	
Contacts	Copper alloy
Surface	Passivated silver
Clamping range/Stripping length	
- Screw connection	0.5 - 2.5 mm ² (AWG 20 - 14) / 8 mm
- Tension clamp connection	0.25 - 2.5 mm ² (AWG 24 - 14) / 8 mm
Clamping torque	
- Screw connection	0.5 - 0.55 Nm
SD blades	
- Screw connection	0.6 x 3.5 oder PZ0
- Tension clamp connection	0.5 x 3 oder 0.6 x 3.5
PE connection	
- Clamping range	0.5 - 4 mm ²
- solid/stranded	0.5 - 4 mm ² / 0.5 - 4 mm ²
- flexible/flexible with wire end ferrule, DIN 46228 pt. 1	0.5 - 4 mm ² / 0.5 - 4 mm ²
- AWG conductor	AWG 20 - 12
- Stripping length	10 mm
- Clamping torque	1.2 - 1.5 Nm
- Blade dimensions	SD 0.8 x 4 mm oder PZ1

Note:

When used properly and as designated, the listed connectors may not be connected or disconnected if there is a live voltage or load! Rated voltage determined on the basis of DIN EN 61984 section 6.19.2.2.
500 V for signal contact.

** For screw connection

Overview

		Size	Rated voltage	Rated current	No. of poles	Tension clamp connection	TOP connection	Screw conn. with wire guard spring	Crimp connection	PUSH IN connection	Page
		4	830 V	20 A	3 + 2 + ⊕	•		•			B.86
		6	830 V	20 A	6 + 2 + ⊕	•		•			B.88
		8	830 V	20 A	10 + 2 + ⊕	•		•			B.90

830 V, 20 A, size 4

3 + 2 + ⊕

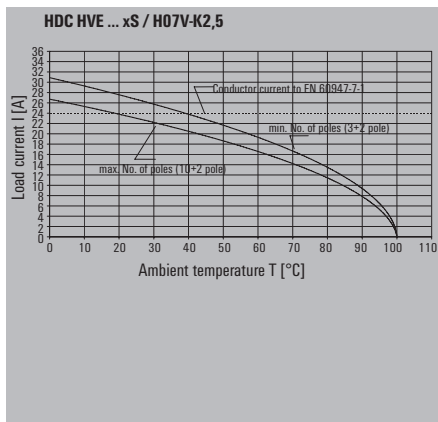
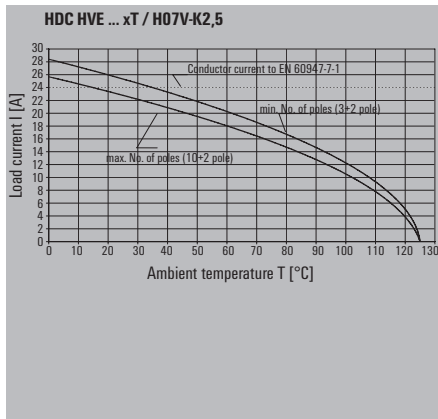

Installation cut-out

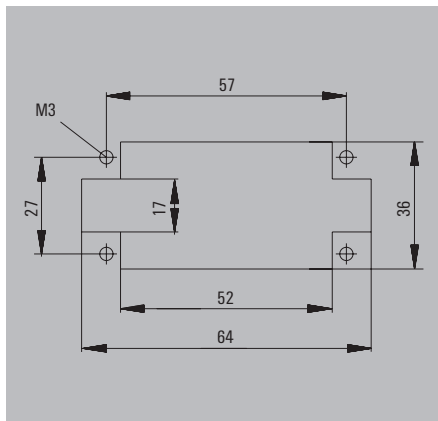

Male

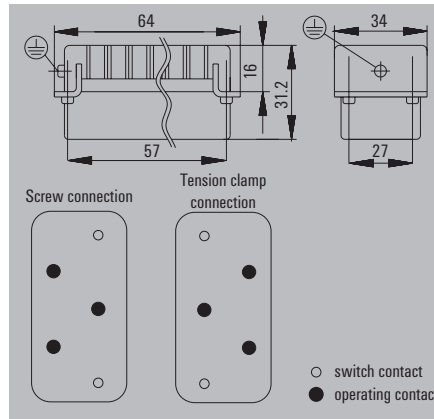

Ordering data

Type of connection	Type	Qty.	Order No.
Tension-clamp conn.	HDC HVE 3+2 MT CTH	1	1967230000
Screw connection	HDC HVE 3+2 MS	1	1651310000

Female

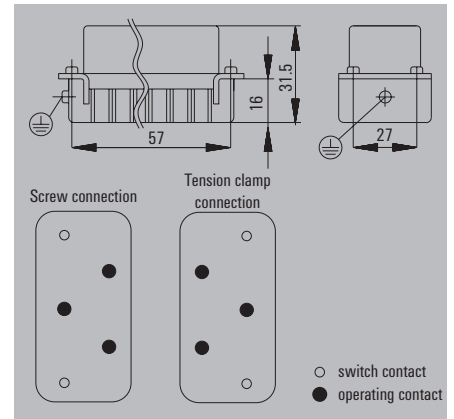

Ordering data

Type of connection	Type	Qty.	Order No.
Tension-clamp conn.	HDC HVE 3+2 FT CTH	1	1967220000
Screw connection	HDC HVE 3+2 FS	1	1651320000

Housing selection RockStar® IP65
Size 4

 For additional housings, refer to
Chapter D for IP65 / Chapter E for IP65 EMC /
Chapter F for IP68 EMC

Hood

Plug housing, cable entry sideways



a	Version	Cover	b (mm)	Type	Order No.
M 20	w. thread		52	HDC 10B TSBU 1M20G	1787560000
M 25	w. thread		52	HDC 10B TSBU 1M25G	1787550000
M 25	w. thread		72	HDC 24D TSBU 1M25G	1787240000
M 32	w. thread		72	HDC 24D TSBU 1M32G	1787230000

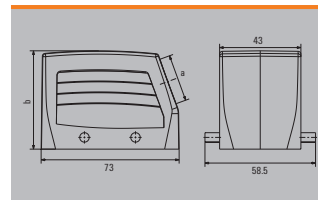

Plug housing, cable entry at top



a	Version	Cover	b (mm)	Type	Order No.
M 20	w. thread		52	HDC 10B TOBU 1M20G	1787600000
M 25	w. thread		52	HDC 10B TOBU 1M25G	1787590000
M 25	w. thread		72	HDC 24D TOBU 1M25G	1787300000
M 32	w. thread		72	HDC 24D TOBU 1M32G	1787290000

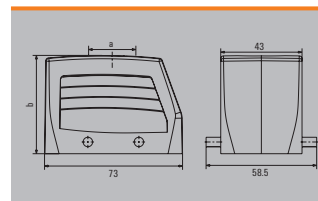

Cover



Version	Type	Order No.
For hoods	HDC 10B DMDQ 2QB	1665240000
For hoods	HDC 10B DMDQ 2QB N	2559740000

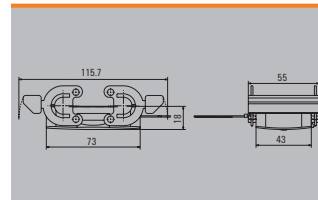

Note: N = Plastic locking lever with stainless steel inlay

Base

Bulkhead housing



Version	Cover	b (mm)	Type	Order No.
Side-locking		29.5	HDC 10B ABU	1205000000
Side-locking		29.5	HDC 10B ABU N	2488580000

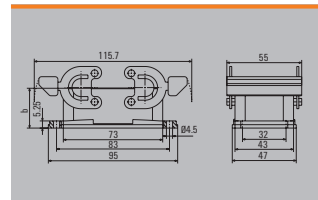

Note: N = Plastic locking lever with stainless steel inlay

Base housing



a	Version	Cover	b (mm)	Type	Order No.
M 20	Side-locking		57	HDC 10B SBU 1M20G N	2560880000
M 20	Side-locking		57	HDC 10B SBU 2M20G	1787640000
M 20	Side-locking		57	HDC 10B SBU 2M20G N	2560890000
M 25	Side-locking		57	HDC 10B SBU 1M25G N	2560900000
M 25	Side-locking		57	HDC 10B SBU 2M25G	1787630000
M 25	Side-locking		57	HDC 10B SBU 2M25G N	2560910000

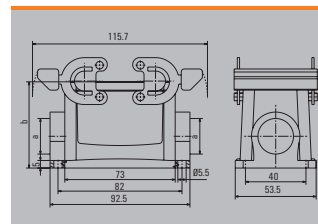

Note: N = Plastic locking lever with stainless steel inlay

Coupling housing



a	Version	Cover	b (mm)	Type	Order No.
M 20	w. thread		54.65	HDC 10B KBU 1M20G	1787720000
M 20	w. thread		54.65	HDC 10B KBU 1M20G N	2559860000

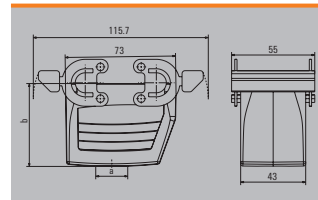

Note: N = Plastic locking lever with stainless steel inlay

Cover



Version	Type	Order No.
For bases	HDC 10B DDDQ 4B0	1665230000

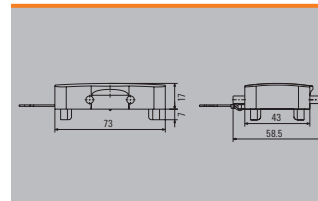

830 V, 20 A, size 6

6 + 2 + ⊕

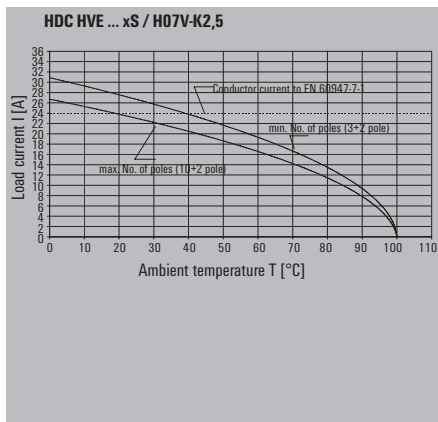
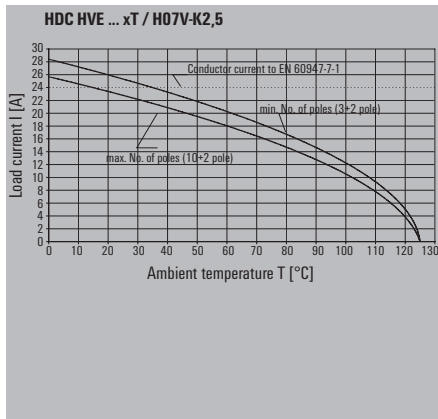

Installation cut-out

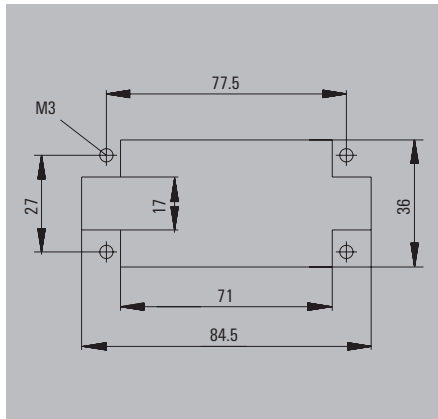

Male

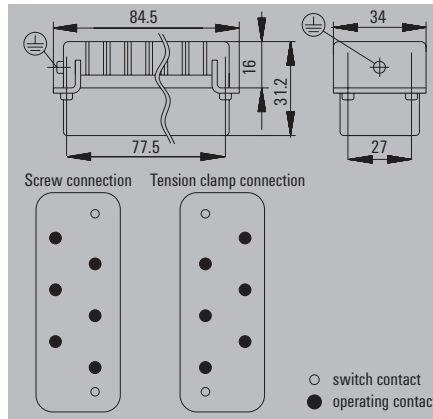

Ordering data

Type of connection	Type	Qty.	Order No.
Screw connection	HDC HVE 6+2 MS	1	1651330000
Tension-clamp conn.	HDC HVE 6+2 MT CTH	1	1967250000

Female

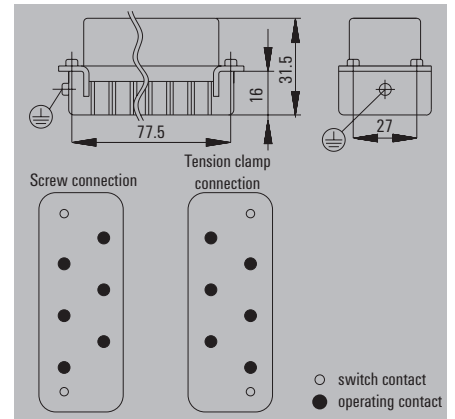

Ordering data

Type of connection	Type	Qty.	Order No.
Tension-clamp conn.	HDC HVE 6+2 FT CTH	1	1967240000
Screw connection	HDC HVE 6+2 FS	1	1651340000

Housing selection RockStar® IP65
Size 6

➔ For additional housings, refer to
Chapter D for IP65 / Chapter E for IP65 EMC /
Chapter F for IP68 EMC

Hood

Plug housing, cable entry sideways



a	Version	Cover	b (mm)	Type	Order No.
M 25	w. thread		61	HDC 16B TSBU 1M25G	1788180000
M 25	w. thread		76	HDC 40D TSBU 1M25G	1787010000
M 32	w. thread		76	HDC 40D TSBU 1M32G	1787000000

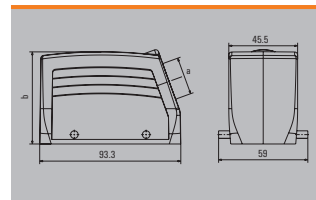

Plug housing, cable entry at top



a	Version	Cover	b (mm)	Type	Order No.
M 25	w. thread		61	HDC 16B TOBU 1M25G	1788210000
M 25	w. thread		76	HDC 40D TOBU 1M25G	1787070000
M 32	w. thread		76	HDC 40D TOBU 1M32G	1787060000

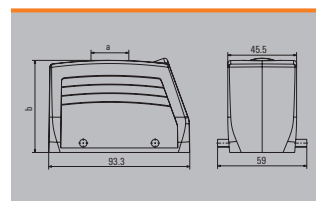

Cover



Version	Type	Order No.
For hoods	HDC 16B DMDQ 2QB	1665270000

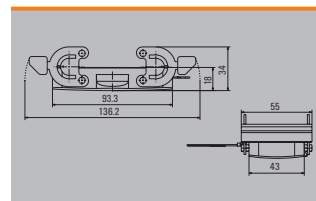

Base

Bulkhead housing



Version	Cover	b (mm)	Type	Order No.
Side-locking		29	HDC 16B ABU	1208600000
Side-locking		29	HDC 16B ABU N	2488590000

Note: N = Plastic locking lever with stainless steel inlay

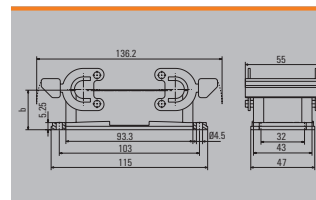

Base housing



a	Version	Cover	b (mm)	Type	Order No.
M 25	Side-locking		64	HDC 16B SBU 1M25G N	2560740000
M 25	Side-locking		64	HDC 16B SBU 2M25G	1788240000
M 25	Side-locking		64	HDC 16B SBU 2M25G N	2560930000
M 25	Side-locking		84	HDC 40D SBU 2M25G	1787120000
PG 21	Side-locking		84	HDC 40D SBU 1M32G N	2561030000
M 32	Side-locking		84	HDC 40D SBU 2M32G	1787110000

Note: N = Plastic locking lever with stainless steel inlay

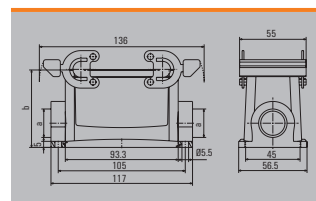

Coupling housing



a	Version	Cover	b (mm)	Type	Order No.
M 25	w. thread		78.6	HDC 40D KBU 1M25G	1787200000
PG 29	w. thread		79	HDC 40D KBU 1M25G N	2559890000
M 32	w. thread		78.6	HDC 40D KBU 1M32G	1787190000
PG 29	w. thread		79	HDC 40D KBU 1M32G N	2559900000
PG 29	w. thread		79	HDC 40D KBU 2M32G N	2545510000

Note: N = Plastic locking lever with stainless steel inlay

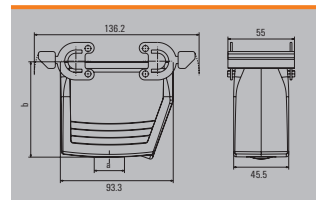

Cover



Version	Type	Order No.
For bases	HDC 16B DDDQ 480	1665260000

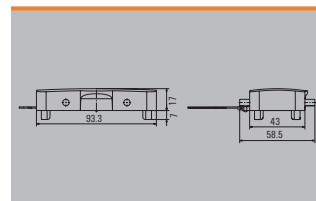

830 V, 20 A, size 8

10 + 2 + ⊕

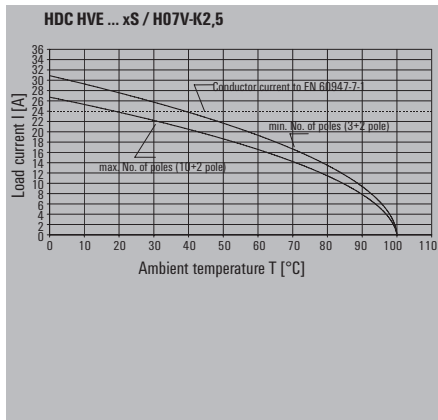
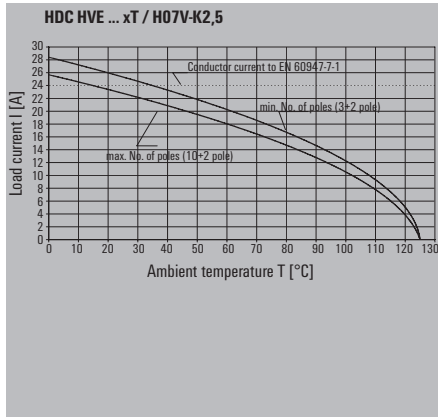

Installation cut-out

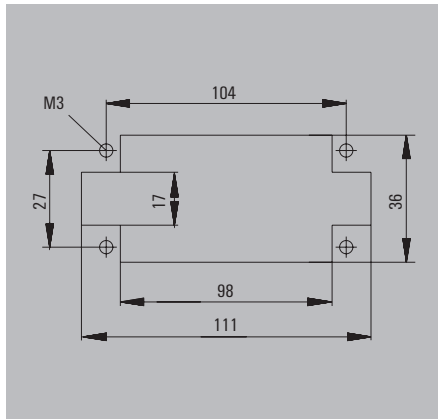

Male

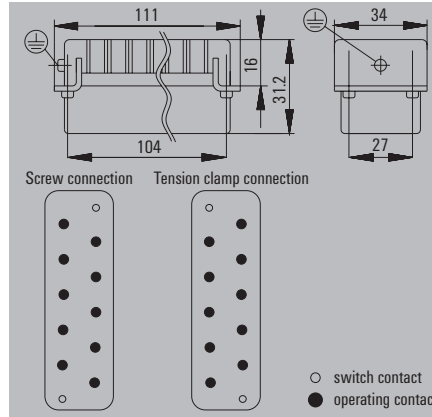

Ordering data

Type of connection	Type	Qty.	Order No.
Tension-clamp conn.	HDC HVE 10+2 MT CTH	1	1967210000
Screw connection	HDC HVE 10+2 MS	1	1651350000

Female

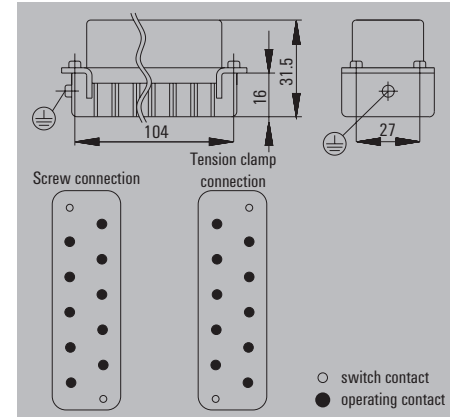

Ordering data

Type of connection	Type	Qty.	Order No.
Screw connection	HDC HVE 10+2 FS	1	1651360000
Tension-clamp conn.	HDC HVE 10+2 FT CTH	1	1967260000

Housing selection RockStar® IP65
Size 8

 For additional housings, refer to
Chapter D for IP65 / Chapter E for IP65 EMC /
Chapter F for IP68 EMC

Hood

Plug housing, cable entry sideways



a	Version	Cover	b (mm)	Type	Order No.
M 25	w. thread		62.58	HDC 24B TSBU 1M25G	1787760000
M 25	w. thread		76	HDC 64D TSBU 1M25G	1786780000
M 32	w. thread		62.58	HDC 24B TSBU 1M32G	1787750000
M 32	w. thread		76	HDC 64D TSBU 1M32G	1786770000

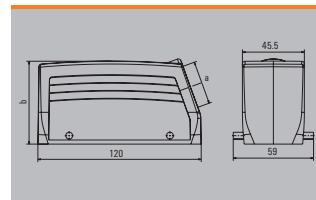

Plug housing, cable entry at top



a	Version	Cover	b (mm)	Type	Order No.
M 25	w. thread		62.58	HDC 24B TOBU 1M25G	1787820000
M 32	w. thread		62.58	HDC 24B TOBU 1M32G	1787810000
M 32	w. thread		76	HDC 64D TOBU 1M32G	1786830000

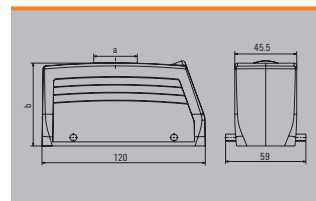

Cover



Version	Type	Order No.
For hoods	HDC 24B DMDQ 2QB	1665640000
For hoods	HDC 24B DMDQ 2QB N	2559760000

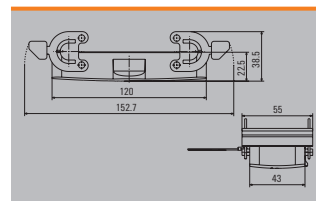

Note: N = Plastic locking lever with stainless steel inlay

Base

Bulkhead housing



Version	Cover	b (mm)	Type	Order No.
Side-locking		29.5	HDC 24B ABU	1212400000
Side-locking		29.5	HDC 24B ABU N	2488600000

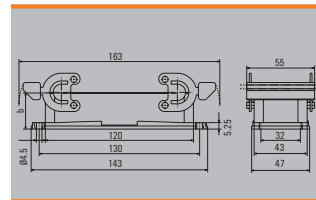

Note: N = Plastic locking lever with stainless steel inlay

Base housing



a	Version	Cover	b (mm)	Type	Order No.
M 25	Side-locking		64	HDC 24B SBU 2M25G	1787870000
M 25	Side-locking		64	HDC 24B SBU 2M25G N	2560970000
M 25	Side-locking		84	HDC 64D SBU 2M25G	1786890000
M 32	Side-locking		84	HDC 64D SBU 2M25G N	2561060000
M 32	Side-locking		84	HDC 64D SBU 1M32G N	2561050000
M 32	Side-locking		84	HDC 64D SBU 2M32G	1786880000

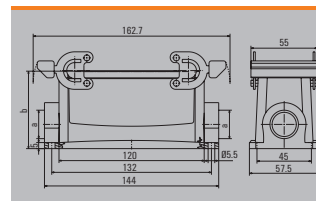

Note: N = Plastic locking lever with stainless steel inlay

Coupling housing



a	Version	Cover	b (mm)	Type	Order No.
M 25	w. thread		65	HDC 24B KBU 1M25G	1787920000
M 25	w. thread		65	HDC 24B KBU 1M25G N	2559870000
M 32	w. thread		65	HDC 24B KBU 2M32G N	2559880000
M 32	w. thread		79	HDC 64D KBU 1M32G	1786960000
M 32	w. thread		79	HDC 64D KBU 1M32G N	2559910000

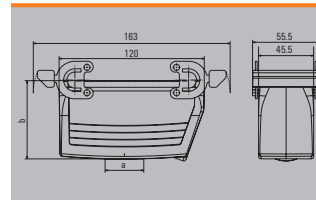

Note: N = Plastic locking lever with stainless steel inlay

Cover



Version	Type	Order No.
For bases	HDC 24B DDDQ 4B0	1665630000

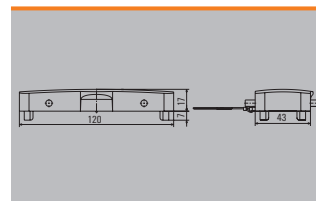

HSB series

Safe: Our HSB inserts are equipped with screw connections, including wire protection springs. They transmit currents up to 35 A per contact.







Technical data

Standards/approvals	
Standards	DIN EN 61984 DIN EN 60664-1
Approvals	UL/CSA
Inserts	
No. of poles	6, 12
Rated voltage	400 V
Rated voltage to UL/CSA	600 V
Rated current	35 A
Rated impulse withstand voltage	6 kV
Pollution severity	3
Insulation resistance	≥ 10 ¹⁰ Ω
Material	Glass-fibre reinforced PC (in UL list and approved for railway applications)
Temperature range	-40 °C to +125 °C
Flammability to UL 94	V-0
Mechanical service life	
- Plugging cycles Ag-Surface	≥ 500
- Plugging cycles Au-Surface	≥ 500
Contact resistance	
Screw connection	≤ 2 mΩ
Contacts/Material	
Sockets and plug-in contact	Copper alloy
Surface	Passivated silver
Screw connection	
- Clamping range	0.5 - 6 mm ² (AWG 20 - 10)
- Stripping length	11 mm
- flex. with wire end ferrule acc. to DIN 46228 pt. 1	4 mm ²
Clamping torque	
- Screw connection	1.2 - 1.5 Nm
SD blades	0.6 x 3.5 or 0.8 x 4 mm
PE connection	
- Clamping range	0.5 - 6 mm ²
- solid/stranded	0.5 - 6 mm ² / 0.5 - 6 mm ²
- flexible/flexible with wire end ferrule, DIN 46228 pt. 1	0.5 - 6 mm ² / 0.5 - 6 mm ²
- AWG conductor	AWG 20 - 10
- Stripping length	10 mm
- Clamping torque	2 - 2.5 Nm
- Blade dimensions	SD 1 x 5.5 mm or PZ2

Note:

When used properly and as designated, the listed connectors may not be connected or disconnected if there is a live voltage or load! When connecting flexible conductor with a screw connection, you should use ferrules, according to DIN 46228, section 1.

Overview

		Size	Rated voltage	Rated current	No. of poles	Tension clamp connection	TOP connection	Screw conn. with wire guard spring	Crimp connection	PUSH IN connection	Page
		6	400 V	35 A	6 + ⊕			•			B.94
		10	400 V	35 A	12 + ⊕			•			B.96

400 V, 35 A, size 6

6 + ⊕

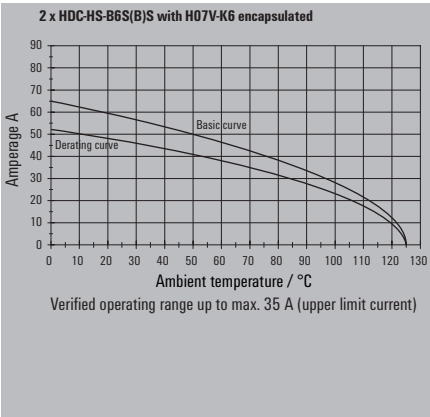

Male

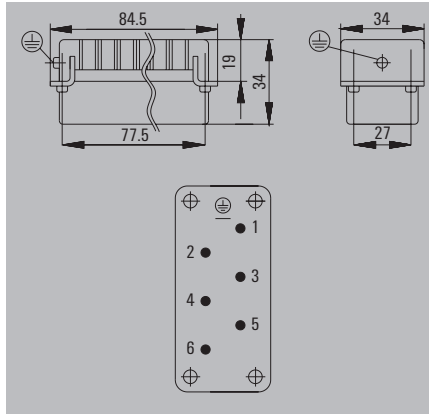

Ordering data

Type of connection	Type	Qty.	Order No.
Screw connection	HDC HSB 6 MS	1	1498700000

Female

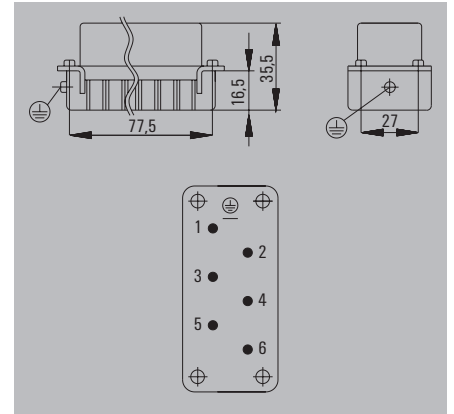

Ordering data

Type of connection	Type	Qty.	Order No.
Screw connection	HDC HSB 6 FS	1	1498900000

Installation cut-out

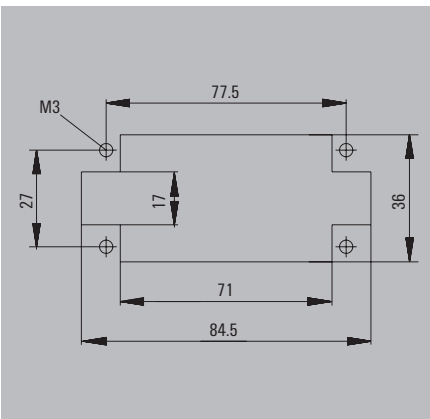

Housing selection RockStar® IP65
Size 6



For additional housings, refer to
Chapter D for IP65 / Chapter E for IP65 EMC /
Chapter F for IP68 EMC

Hood

Plug housing, cable entry sideways



a	Version	Cover	b (mm)	Type	Order No.
M 25	w. thread		61	HDC 16B TSBU 1M25G	1788180000
M 25	w. thread		76	HDC 40D TSBU 1M25G	1787010000
M 32	w. thread		76	HDC 40D TSBU 1M32G	1787000000

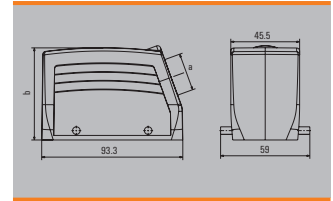

Plug housing, cable entry at top



a	Version	Cover	b (mm)	Type	Order No.
M 25	w. thread		61	HDC 16B TOBU 1M25G	1788210000
M 25	w. thread		76	HDC 40D TOBU 1M25G	1787070000
M 32	w. thread		76	HDC 40D TOBU 1M32G	1787060000

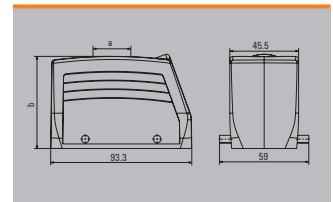

Cover



Version	Type	Order No.
For hoods	HDC 16B DMDQ 2QB	1665270000

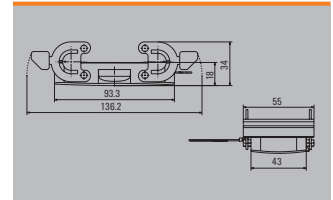

Base

Bulkhead housing



Version	Cover	b (mm)	Type	Order No.
Side-locking		29	HDC 16B ABU	1208600000
Side-locking		29	HDC 16B ABU N	2488590000

Note: N = Plastic locking lever with stainless steel inlay

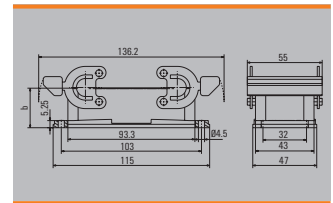

Base housing



a	Version	Cover	b (mm)	Type	Order No.
M 25	Side-locking		64	HDC 16B SBU 1M25G N	2560740000
M 25	Side-locking		64	HDC 16B SBU 2M25G	1788240000
M 25	Side-locking		64	HDC 16B SBU 2M25G N	2560930000
M 25	Side-locking		84	HDC 40D SBU 2M25G	1787120000
PG 21	Side-locking		84	HDC 40D SBU 1M32G N	2561030000
M 32	Side-locking		84	HDC 40D SBU 2M32G	1787110000

Note: N = Plastic locking lever with stainless steel inlay

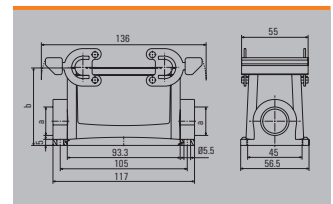

Coupling housing



a	Version	Cover	b (mm)	Type	Order No.
M 25	w. thread		78.6	HDC 40D KBU 1M25G	1787200000
PG 29	w. thread		79	HDC 40D KBU 1M25G N	2559890000
M 32	w. thread		78.6	HDC 40D KBU 1M32G	1787190000
PG 29	w. thread		79	HDC 40D KBU 1M32G N	2559900000
PG 29	w. thread		79	HDC 40D KBU 2M32G N	2545510000

Note: N = Plastic locking lever with stainless steel inlay

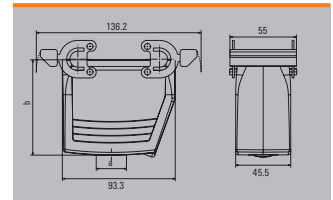

Cover



Version	Type	Order No.
For bases	HDC 16B DDDQ 480	1665260000

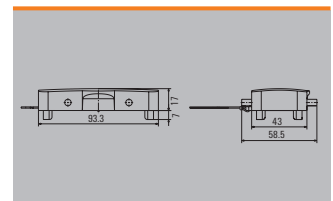

400 V, 35 A, size 10

12 + ⊕

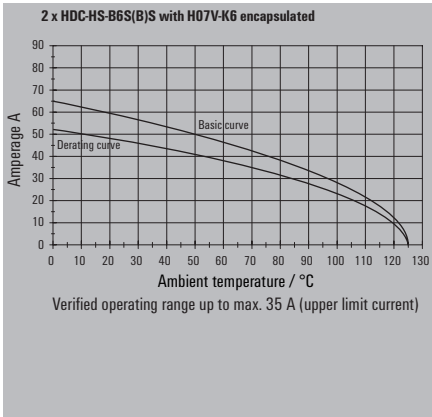

Male

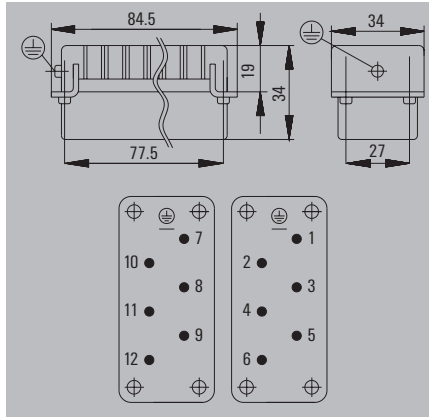

Ordering data

Type of connection	Type	Qty.	Order No.
Screw connection	HDC HSB 6 MS	1	1498700000
Screw connection	HDC HSB 6 MS 7 - 12	1	1498800000

Female

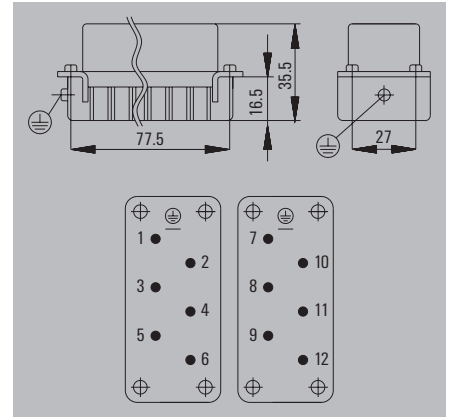

Ordering data

Type of connection	Type	Qty.	Order No.
Screw connection	HDC HSB 6 FS	1	1498900000
Screw connection	HDC HSB 6 FS 7 - 12	1	1499000000

Installation cut-out

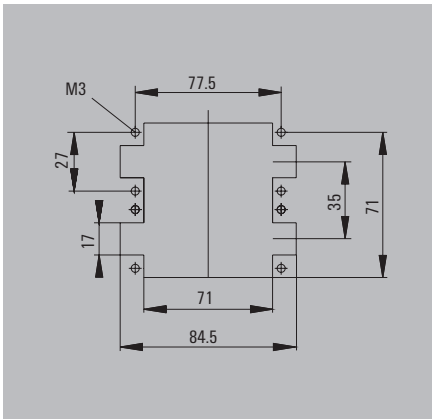

Housing selection RockStar® IP65
Size 10



For additional housings, refer to chapter D for IP65

Hood

Plug housing, cable entry sideways



a	Version	Cover	b (mm)	Type	Order No.
M 32	w. thread		79	HDC 32B TSLU 1M32G	1788420000

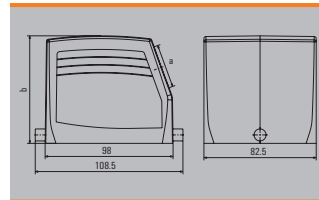

Base

Bulkhead housing



Version	Cover	b (mm)	Type	Order No.
End-locking		38	HDC 32B ALU	1219500000
End-locking	with cover	55	HDC 32B ADLU	1219800000

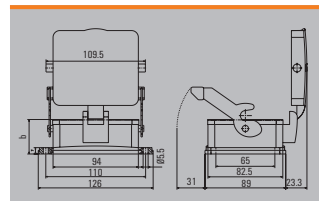

Base housing



a	Version	Cover	b (mm)	Type	Order No.
M 32	End-locking		79	HDC 32B SLU 2M32G	1788470000
M 32	End-locking	with cover	96	HDC 32B SDLU 2M32G	1788490000

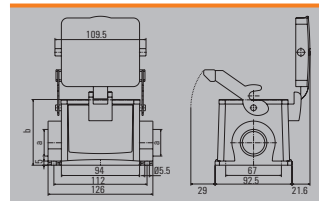

Coupling housing



a	Version	Cover	b (mm)	Type	Order No.
M 32	w. thread		83	HDC 32B KLU 1M32G	1788500000

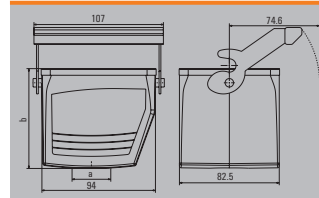

HQ series

Flexible: Our HQ inserts are the first choice when you need to implement particularly compact yet hybrid wiring solutions.

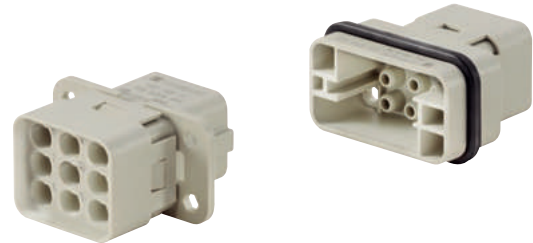













Technical data

	HQ 5	HQ 7	HQ 12	HQ 8	HQ 4/2	HQ 17
Standards/approvals						
Standards	DIN EN 61984 DIN EN 60664-1	DIN EN 61984 DIN EN 60664-1	DIN EN 61984 DIN EN 60664-1	DIN EN 61984 DIN EN 60664-1	DIN EN 61984 DIN EN 60664-1	DIN EN 61984 DIN EN 60664-1
Approvals	UL/CSA	UL/CSA	UL/CSA	UL/CSA/ISO 23570	UL/CSA/ISO 23570	UL/CSA
Inserts						
No. of poles	5 + PE	7 + PE	12 + PE	8 + PE	4 Leistung, 2 Signale + PE	17 + PE
Connection system	Crimp, HE-contact	Crimp, HD-contact	Crimp, HD-contact	Crimp, HE-contact	Crimp, HX-/HD-contact	Crimp, HD-contact
Rated voltage	250 V	400 V	400 V	500 V	690 V, 250 V	250 V
Rated voltage to UL/CSA	600 V	600 V	600 V	600 V	600 V	600 V
Rated current	16 A	10 A	10 A	16 A	40/10 A	10 A
Rated impulse withstand voltage	4 kV	6 kV	6 kV	6 kV	6 kV/4 kV	4 kV
Pollution severity	3	3	3	3	3	2
Insulation resistance	≥ 10 ¹⁸ Ω	≥ 10 ¹⁸ Ω	≥ 10 ¹⁸ Ω	≥ 10 ¹⁸ Ω	≥ 10 ¹⁸ Ω	≥ 10 ¹⁸ Ω
Material	PC glass-fibre reinforced	PC glass-fibre reinforced	PA glass-fibre reinforced	PC glass-fibre reinforced	PC glass-fibre reinforced	PC glasfaserverstärkt
Temperature range	-40° to +125° C	-40° to +125° C	-40° to +125° C	-40° to +125° C	-40° to +125° C	-40° to +125° C
Flammability to UL 94	V-0	V-0	V-0	V-0	V-0	V-0
Mechanical service life						
- Plugging cycles Ag - Surface	≥ 500	≥ 500	≥ 500	≥ 500	≥ 500	≥ 500
- Plugging cycles Au - Surface	≥ 500	≥ 500	≥ 500	≥ 500	≥ 500	≥ 500
Volume (continuity) resistance of crimp connection	≤ 2 mΩ	≤ 4 mΩ	≤ 4 mΩ	≤ 2 mΩ	≤ 1 mΩ/≤ 4 mΩ	≤ 4 mΩ
Contacts/Material						
Sockets and plug-in contact	Copper alloy	Copper alloy	Copper alloy	Copper alloy	Copper alloy	Copper alloy
Surface	Passivated silver	Passivated silver/gold	Passivated silver/gold	Passivated silver	Passivated silver/gold	Passivated silver/gold
Crimp connection						
- Performance power range	0.5 - 4 mm ² (AWG 20 - 12)			0.5 - 4 mm ² (AWG 20...12)	1.5 - 6 mm ² (AWG 16...10)	
- Signal range		0.14 - 2.5 mm ² (AWG 26 - 14)	0.14 - 2.5 mm ² (AWG 26 - 14)		0.14 - 2.5 mm ² (AWG 26 - 14)	0.14 - 2.5 mm ² (AWG 26 - 14)
- Stripping length	7.5 mm	8.0 mm	8.0 mm	7.5 mm	9 mm/8 mm	8.0 mm
PE connection						
- Clamping range	0.5 - 2.5 mm ²	0.14 - 2.5 mm ²	0.14 - 2.5 mm ²	0.5 - 4 mm ²	1.5 - 6 mm ²	0.14 - 2.5 mm ²
- solid core/stranded	0.5 - 2.5 mm ² / 0.5 - 2.5 mm ²	0.14 - 2.5 mm ²	0.14 - 2.5 mm ²	0.5 - 4 mm ²		
- flexible/flexible with ferrule	0.5 - 2.5 mm ² / 0.5 - 2.5 mm ²	0.14 - 2.5 mm ²	0.14 - 2.5 mm ²	0.5 - 4 mm ²		
- AWG conductor	AWG 20 - 14	AWG 26 - 14	AWG 26 - 14	AWG 20 - 12	AWG 16 - 10	AWG 26 - 14
- Stripping length	10 mm	5 mm	5 mm	7.5 mm	9 mm	8 mm
- Clamping torque	0.5 - 0.55 Nm	0.5 - 0.55 Nm	0.5...0.55 Nm			
- Blade dimensions	SD 0.8 x 4 mm	SD 0.8 x 4 mm	SD 0.8 x 4 mm			
Accessories and tools						
Crimping tools used	9205430000	9205430000	9205430000	9205430000	9205430000	9205430000 C
	CTIN CM 1.6/2.5	CTIN CM 1.6/2.5	CTIN CM 1.6/2.5	CTIN CM 1.6/2.5	CTIN CM 1.6/2.5	TIN CM 1.6/2.5
	9018490000	9018490000	9018490000	9018490000	9205440000	9018490000
	CTX CM 1.6/2.5	CTX CM 1.6/2.5	CTX CM 1.6/2.5	CTX CM 1.6/2.5	CTIN CM 3.6	CTX CM 1.6/2.5
				9018490000 CTX CM 1.6/2.5		
Screwdriver				Version Crosshead, shape H	Version Crosshead, shape H	Version Crosshead, shape H
				Sheet metal screw:	Sheet metal screw:	Sheet metal screw:
				ISO 7049-ST 2.9 x 9.5-F-H	ISO 7049-ST 2.9 x 9.5-F-H	ISO 7049-ST 2.9 x 9.5-F-H
Removal tool for crimps	1866750000 Removal Tool HE	1866730000 Removal Tool HD	1866730000 Removal Tool HD	1866750000 Removal Tool HE	1002990000 Removal Tool HX	1866730000 Removal Tool HD
				1866730000 Removal Tool HD		

Note:
When used properly and as designated, the listed connectors may not be connected or disconnected if there is a live voltage or load!

Overview

		Size	Rated voltage	Rated current	No. of poles	Tension clamp connection	TOP connection	Screw conn. with wire guard spring	Crimp connection	PUSH IN connection	Page
		1	250 V	16 A	5 + ⊕				•		B.100
		1	400 V	10 A	7 + ⊕				•		B.102
		1	400 V	10 A	12 + ⊕				•		B.104
		HQ	500 V	16 A	8 + ⊕				•		B.106
		HQ	250 V	10 A	17 + ⊕				•		B.108
		HQ	690/250 V	40/10 A	4 + 2 + ⊕				•		B.110

250 V, 16 A, size 1

5 + ⊕

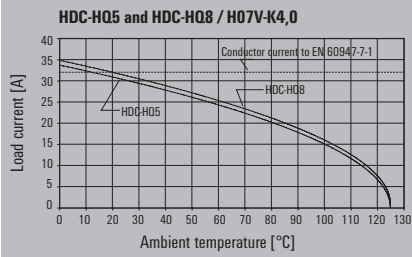

Male

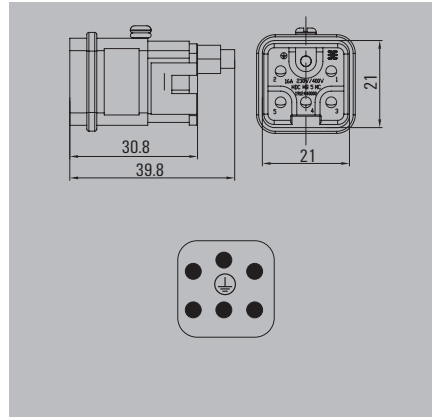

Ordering data

Type of connection	Type	Qty.	Order No.
Crimp connection	HDC HQ 5 MC	1	1912440000

Accessories

Type	Qty.	Order No.
Crimp contacts, male - gold		
HDC-C-HE-SM0.5AU	100	1651420000
HDC-C-HE-SM0.75-1.00AU	100	1651430000
HDC-C-HE-SM1.5AU	100	1651440000
HDC-C-HE-SM2.5AU	100	1651450000
HDC-C-HE-SM4.0AU	100	1651460000
Crimp contacts, male - silver		
HDC-C-HE-SM0.5AG	100	1200500000
HDC-C-HE-SM0.75-1.00AG	100	1200600000
HDC-C-HE-SM1.5AG	100	1200700000
HDC-C-HE-SM2.5AG	100	1200800000
HDC-C-HE-SM4.0AG	100	1200900000
Coding pins		
HDC HE CP	100	1003240000
Tools		
CTX CM 1.6/2.5	1	9018490000
CTIN CM 1.6/2.5	1	9205430000
REMOVAL TOOL HE	1	1866750000

Installation cut-out



Female

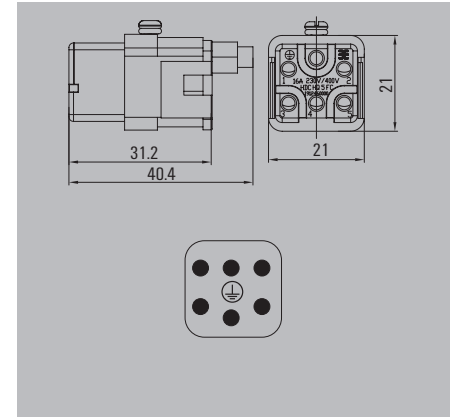

Ordering data

Type of connection	Type	Qty.	Order No.
Crimp connection	HDC HQ 5 FC	1	1912460000

Accessories

Type	Qty.	Order No.
Crimp contacts, female - gold		
HDC-C-HE-BM0.5AU	100	1651470000
HDC-C-HE-BM0.75-1.00AU	100	1651480000
HDC-C-HE-BM1.5AU	100	1651490000
HDC-C-HE-BM2.5AU	100	1651500000
HDC-C-HE-BM4.0AU	100	1651510000
Crimp contacts, female - silver		
HDC-C-HE-BM0.5AG	100	1201100000
HDC-C-HE-BM0.75-1.00AG	100	1201200000
HDC-C-HE-BM1.5AG	100	1201300000
HDC-C-HE-BM2.5AG	100	1201400000
HDC-C-HE-BM4.0AG	100	1201500000
Tools		
CTX CM 1.6/2.5	1	9018490000
CTIN CM 1.6/2.5	1	9205430000
REMOVAL TOOL HE	1	1866750000

Housing selection RockStar® IP65
Size 1



For additional housings, refer to
Chapter D for IP65 / Chapter F for IP68 EMC

Hood

Plug housing, cable entry sideways



Material: diecast aluminium

a	Version	Cover	b (mm)	Type	Order No.
M 20	w. thread		49.2	HDC 04A TWLU 1M20G	1788810000

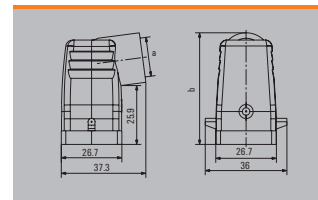

Plug housing, cable entry at top



Material: diecast aluminium

a	Version	Cover	b (mm)	Type	Order No.
M 20	w. thread		50	HDC 04A TOLU 1M20G	1788820000

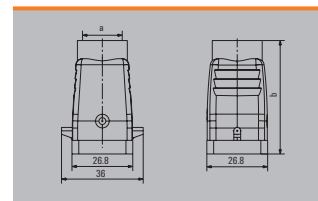

Base

Bulkhead housing



Material: diecast aluminium

Version	Cover	b (mm)	Type	Order No.
Side-locking		23	HDC 04A ALU	1497600000

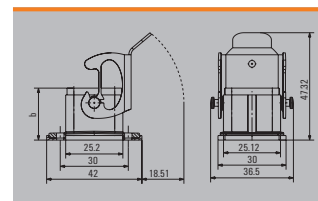

Base housing



Material: diecast aluminium

a	Version	Cover	b (mm)	Type	Order No.
M 20	Side-locking		41.5	HDC 04A SLU 1M20G	1788830000

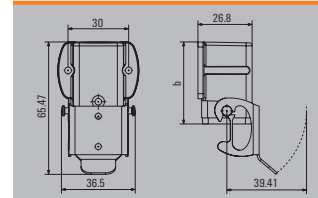

Coupling housing



Material: diecast aluminium

a	Version	Cover	b (mm)	Type	Order No.
M 20	w. thread		53.5	HDC 04A KOLU 1M20G	1788840000

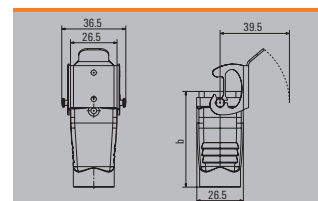

Screw mounting housing



Material: diecast aluminium

a	Version	Cover	b (mm)	Type	Order No.
M 20	w. thread		54	HDC 04A ELU 1M20G	1900320000

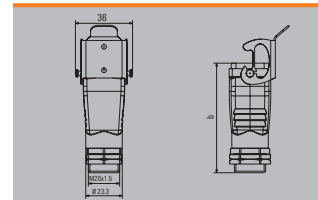

Cover



Material: diecast aluminium

Version	Type	Order No.
with female	HDC 04A DMDL 2B0	1665750000
with male	HDC 04A DDDL 2B0	1665740000

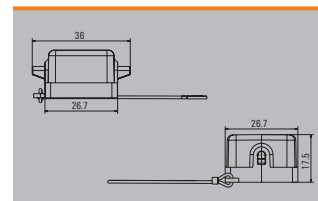

400 V, 10 A, size 1

7 + ⊕

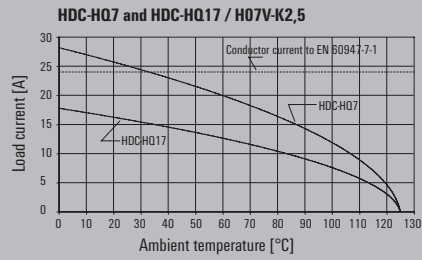

Male

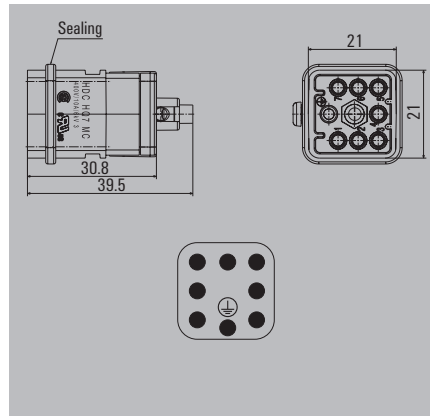

Ordering data

Type of connection	Type	Qty.	Order No.
Crimp connection	HDC HQ 7 MC	1	1003190000

Accessories

Type	Qty.	Order No.
Crimp contacts, male - gold		
HDC-C-HD-SM0.14-0.37AU	100	1651620000
HDC-C-HD-SM0.5AU	100	1651630000
HDC-C-HD-SM0.75-1.00AU	100	1651640000
HDC-C-HD-SM1.5AU	100	1651650000
HDC-C-HD-SM2.5AU	100	1651660000
Crimp contacts, male - silver		
HDC-C-HD-SM0.14-0.37AG	100	1651520000
HDC-C-HD-SM0.5AG	100	1651530000
HDC-C-HD-SM0.75-1.00AG	100	1601750000
HDC-C-HD-SM1.5AG	100	1651550000
HDC-C-HD-SM2.5AG	100	1651560000
Coding pins		
HDC HQ 7 CPM	50	1003230000
HDC HQ 7 CPF	50	1003220000
Tools		
CTX CM 1.6/2.5	1	9018490000
CTIN CM 1.6/2.5	1	9205430000
REMOVAL TOOL HD	1	1866730000

Female

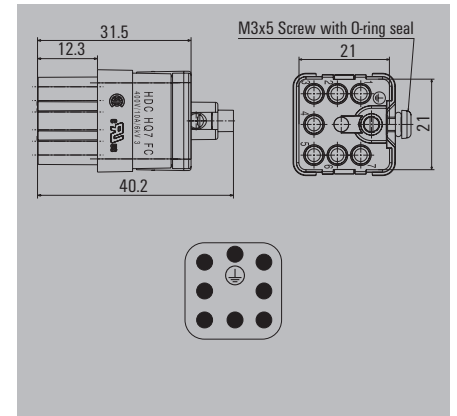

Ordering data

Type of connection	Type	Qty.	Order No.
Crimp connection	HDC HQ 7 FC	1	1003180000

Accessories

Type	Qty.	Order No.
Crimp contacts, female - gold		
HDC-C-HD-BM0.14-0.37AU	100	1651670000
HDC-C-HD-BM0.5AU	100	1651680000
HDC-C-HD-BM0.75-1.00AU	100	1651690000
HDC-C-HD-BM1.5AU	100	1651700000
HDC-C-HD-BM2.5AU	100	1651710000
Crimp contacts, female - silver		
HDC-C-HD-BM0.14-0.37AG	100	1651570000
HDC-C-HD-BM0.5AG	100	1651580000
HDC-C-HD-BM0.75-1.00AG	100	1601760000
HDC-C-HD-BM1.5AG	100	1651600000
HDC-C-HD-BM2.5AG	100	1651610000
Coding pins		
HDC HQ 7 CPM	50	1003230000
HDC HQ 7 CPF	50	1003220000
Tools		
CTX CM 1.6/2.5	1	9018490000
CTIN CM 1.6/2.5	1	9205430000
REMOVAL TOOL HD	1	1866730000

Installation cut-out



Housing selection RockStar® IP65
Size 1



For additional housings, refer to
Chapter D for IP65 / Chapter F for IP68 EMC

Hood

Plug housing, cable entry sideways



Material: diecast aluminium

a	Version	Cover	b (mm)	Type	Order No.
M 20	w. thread		49.2	HDC 04A TWLU 1M20G	1788810000

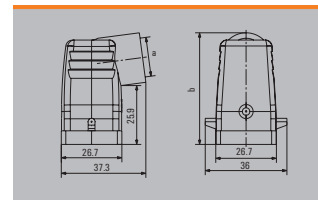

Plug housing, cable entry at top



Material: diecast aluminium

a	Version	Cover	b (mm)	Type	Order No.
M 20	w. thread		50	HDC 04A TOLU 1M20G	1788820000

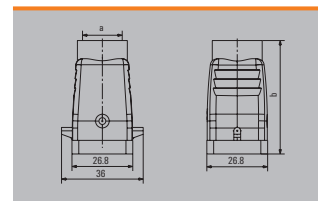

Base

Bulkhead housing



Material: diecast aluminium

Version	Cover	b (mm)	Type	Order No.
Side-locking		23	HDC 04A ALU	1497600000

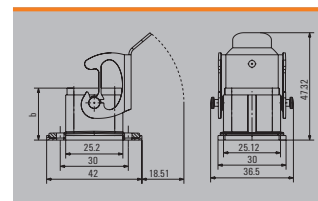

Base housing



Material: diecast aluminium

a	Version	Cover	b (mm)	Type	Order No.
M 20	Side-locking		41.5	HDC 04A SLU 1M20G	1788830000

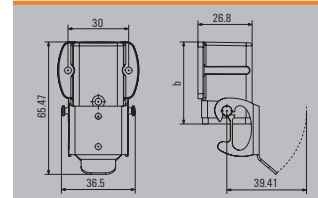

Coupling housing



Material: diecast aluminium

a	Version	Cover	b (mm)	Type	Order No.
M 20	w. thread		53.5	HDC 04A KOLU 1M20G	1788840000

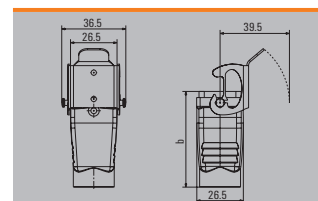

Screw mounting housing



Material: diecast aluminium

a	Version	Cover	b (mm)	Type	Order No.
M 20	w. thread		54	HDC 04A ELU 1M20G	1900320000

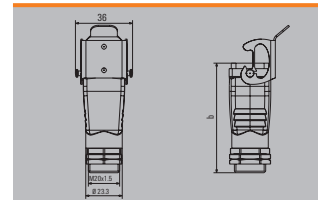

Cover



Material: diecast aluminium

Version	Type	Order No.
with female	HDC 04A DMDL 2B0	1665750000
with male	HDC 04A DDDL 2B0	1665740000

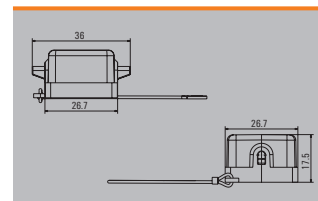

400 V, 10 A, size 1
12 + ⊕

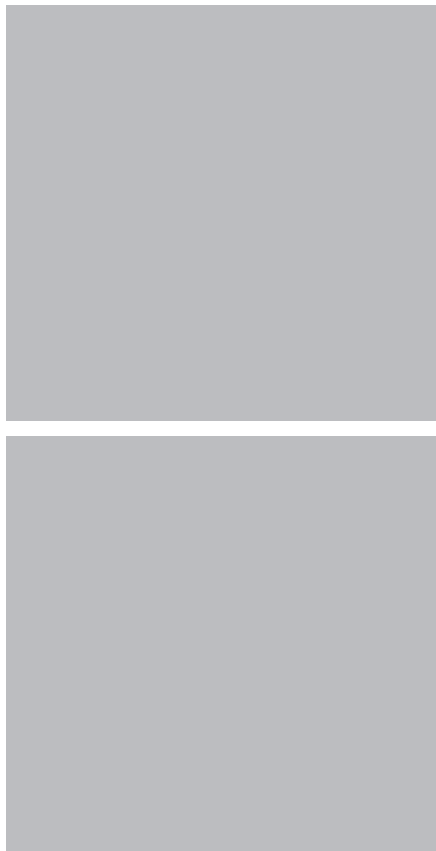

Installation cut-out



Male

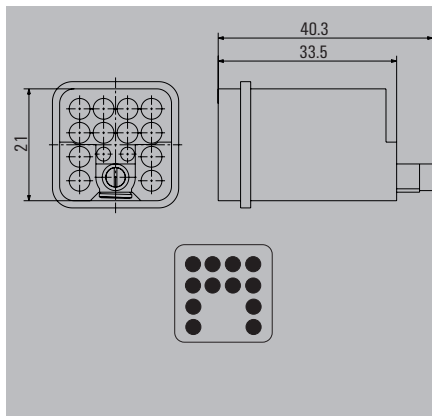

Ordering data

Type of connection	Type	Qty.	Order No.
Crimp connection	HDC HQ 12 MC	10	1993810000

Accessories

Type	Qty.	Order No.
Crimp contacts, male - gold		
HDC-C-HD-SM0.14-0.37AU	100	1651620000
HDC-C-HD-SM0.5AU	100	1651630000
HDC-C-HD-SM0.75-1.00AU	100	1651640000
HDC-C-HD-SM1.5AU	100	1651650000
HDC-C-HD-SM2.5AU	100	1651660000
Crimp contacts, male - silver		
HDC-C-HD-SM0.14-0.37AG	100	1651520000
HDC-C-HD-SM0.5AG	100	1651530000
HDC-C-HD-SM0.75-1.00AG	100	1601750000
HDC-C-HD-SM1.5AG	100	1651550000
HDC-C-HD-SM2.5AG	100	1651560000
Tools		
CTX CM 1.6/2.5	1	9018490000
CTIN CM 1.6/2.5	1	9205430000
REMOVAL TOOL HD	1	1866730000

Female

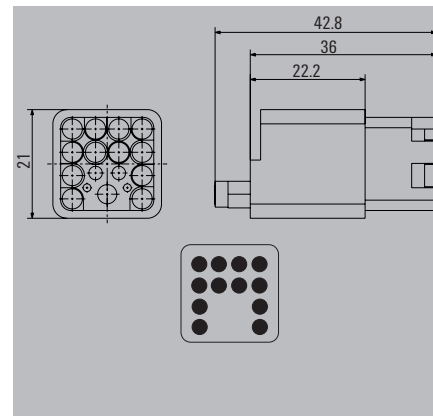

Ordering data

Type of connection	Type	Qty.	Order No.
Crimp connection	HDC HQ 12 FC	10	1993820000

Accessories

Type	Qty.	Order No.
Crimp contacts, female - gold		
HDC-C-HD-BM0.14-0.37AU	100	1651670000
HDC-C-HD-BM0.5AU	100	1651680000
HDC-C-HD-BM0.75-1.00AU	100	1651690000
HDC-C-HD-BM1.5AU	100	1651700000
HDC-C-HD-BM2.5AU	100	1651710000
Crimp contacts, female - silver		
HDC-C-HD-BM0.14-0.37AG	100	1651570000
HDC-C-HD-BM0.5AG	100	1651580000
HDC-C-HD-BM0.75-1.00AG	100	1601760000
HDC-C-HD-BM1.5AG	100	1651600000
HDC-C-HD-BM2.5AG	100	1651610000
Tools		
CTX CM 1.6/2.5	1	9018490000
CTIN CM 1.6/2.5	1	9205430000
REMOVAL TOOL HD	1	1866730000

Housing selection RockStar® IP68
Size 1

Hood

Plug housing, cable entry at top



a	Version	Cover	b (mm)	Type	Order No.
M 20	w. thread			HDC IP68 04A TOS 1M20	1082390000
M 25	w. thread			HDC IP68 04A TOS 1M25G	1513390000
PG 13.5	w. thread			HDC IP68 04A TOS 1PG13	1082410000

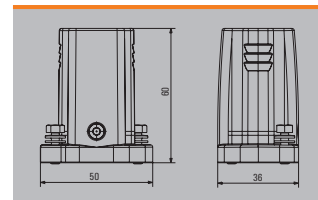

Base

Bulkhead housing



Version	Cover	b (mm)	Type	Order No.
Clamping yoke conn.			HDC IP68 04A AS	1081470000

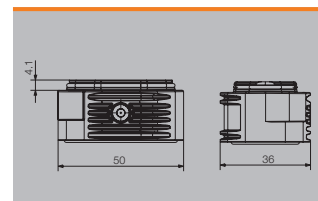

Angled bulkhead housing



Version	Cover	b (mm)	Type	Order No.
Clamping yoke conn.			HDC IP68 04A AWS 1M20	1081480000
Clamping yoke conn.			HDC IP68 04A AWS	1081490000
Clamping yoke conn.			HDC IP68 04A AWS 1M25	2430170000

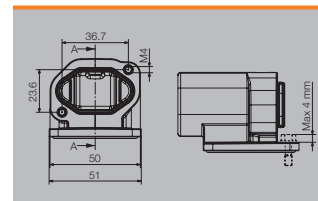

Adapter



a	Version	Cover	b (mm)	Type	Order No.
				HDC IP68 04A ADS	1083130000

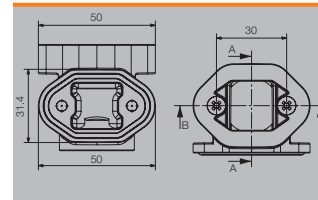

Cover



Version	Type	Order No.
	HDC IP68 04A COVER	1083110000

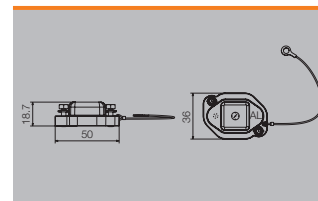

500 V, 16 A, size HQ

8 + ⊕

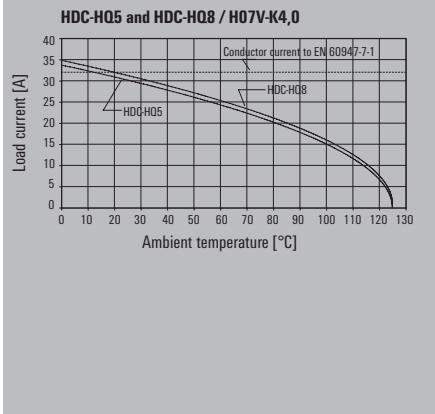

Male

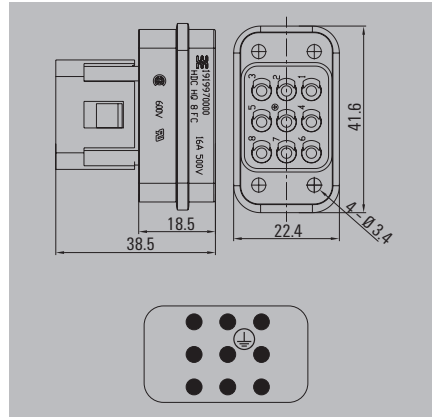

Ordering data

Type of connection	Type	Qty.	Order No.
Crimp connection	HDC HQ 8 MC	1	1919970000

Accessories

Type	Qty.	Order No.
Crimp contacts, male - gold		
HDC-C-HE-SM0.5AU	100	1651420000
HDC-C-HE-SM0.75-1.00AU	100	1651430000
HDC-C-HE-SM1.5AU	100	1651440000
HDC-C-HE-SM2.5AU	100	1651450000
HDC-C-HE-SM4.0AU	100	1651460000
Crimp contacts, male - silver		
HDC-C-HE-SM0.5AG	100	1200500000
HDC-C-HE-SM0.75-1.00AG	100	1200600000
HDC-C-HE-SM1.5AG	100	1200700000
HDC-C-HE-SM2.5AG	100	1200800000
HDC-C-HE-SM4.0AG	100	1200900000
Coding pins		
HDC HE CP	100	1003240000
Tools		
CTX CM 1.6/2.5	1	9018490000
CTIN CM 1.6/2.5	1	9205430000
REMOVAL TOOL HE	1	1866750000

Installation cut-out



Female

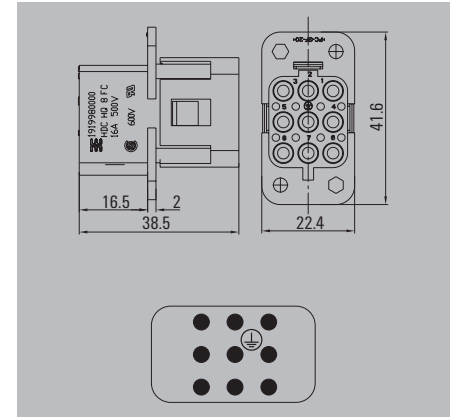

Ordering data

Type of connection	Type	Qty.	Order No.
Crimp connection	HDC HQ 8 FC	1	1919980000

Accessories

Type	Qty.	Order No.
Crimp contacts, female - gold		
HDC-C-HE-BM0.5AU	100	1651470000
HDC-C-HE-BM0.75-1.00AU	100	1651480000
HDC-C-HE-BM1.5AU	100	1651490000
HDC-C-HE-BM2.5AU	100	1651500000
HDC-C-HE-BM4.0AU	100	1651510000
Crimp contacts, female - silver		
HDC-C-HE-BM0.5AG	100	1201100000
HDC-C-HE-BM0.75-1.00AG	100	1201200000
HDC-C-HE-BM1.5AG	100	1201300000
HDC-C-HE-BM2.5AG	100	1201400000
HDC-C-HE-BM4.0AG	100	1201500000
Tools		
CTX CM 1.6/2.5	1	9018490000
CTIN CM 1.6/2.5	1	9205430000
REMOVAL TOOL HE	1	1866750000

**Housing selection RockStar® IP65
Size HQ**

Hood

Plug housing, cable entry sideways



a	Version	Cover	b (mm)	Type	Order No.
PG 16	w. thread		54	HDC HQP TSLU 1PG16	1003090000

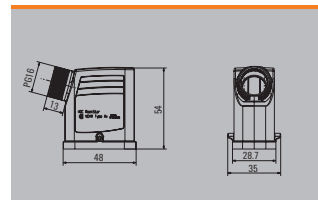

Plug housing, cable entry at top



a	Version	Cover	b (mm)	Type	Order No.
PG 16	w. thread		67	HDC HQP TOLU 1PG16	1003070000

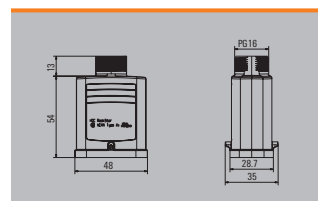

Base

Bulkhead housing



Version	Cover	b (mm)	Type	Order No.
Side-locking		19.5	HDC HQP ALU	1003040000

Note CS: with lockable lever

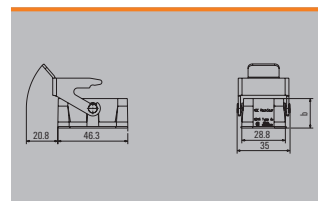

Bulkhead housing angled



Version	Cover	b (mm)	Type	Order No.
Side-locking		54.5	HDC HQP AWLU	1003060000

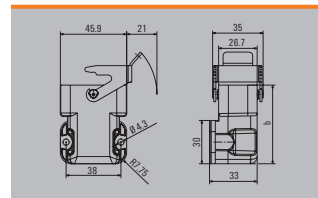

Base housing



a	Version	Cover	b (mm)	Type	Order No.
PG 16	Side-locking		54.5	HDC HQP SLU 1PG16	1003110000

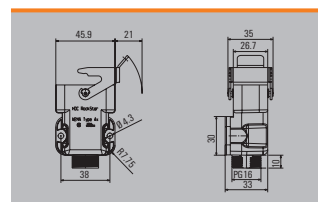

Coupling housing



a	Version	Cover	b (mm)	Type	Order No.
PG 16	w. thread		63.5	HDC HQP KOLU 1PG16	1003120000

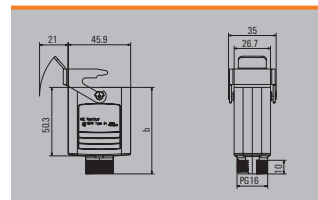

Cover



Version	Type	Order No.
with female	HDC HQP DMD 2B0	1003130000
with male	HDC HQP DDD 2B0	1003140000

Note for plastic and metal housings, with lockable lever

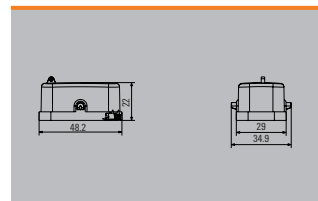

250 V, 10 A, size HQ

17 + ⊕

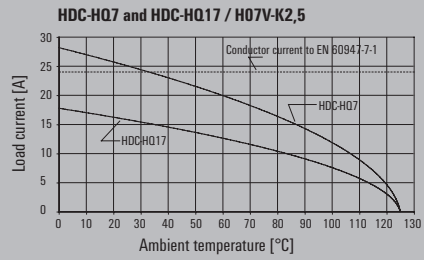

Male

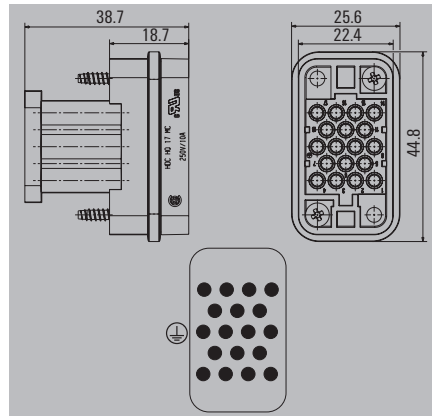

Ordering data

Type of connection	Type	Qty.	Order No.
Crimp connection	HDC HQ 17 MC	1	1003210000

Accessories

Type	Qty.	Order No.
Crimp contacts, male - gold		
HDC-C-HD-SM0.14-0.37AU	100	1651620000
HDC-C-HD-SM0.5AU	100	1651630000
HDC-C-HD-SM0.75-1.00AU	100	1651640000
HDC-C-HD-SM1.5AU	100	1651650000
HDC-C-HD-SM2.5AU	100	1651660000
Crimp contacts, male - silver		
HDC-C-HD-SM0.14-0.37AG	100	1651520000
HDC-C-HD-SM0.5AG	100	1651530000
HDC-C-HD-SM0.75-1.00AG	100	1601750000
HDC-C-HD-SM1.5AG	100	1651550000
HDC-C-HD-SM2.5AG	100	1651560000
Tools		
CTX CM 1.6/2.5	1	9018490000
CTIN CM 1.6/2.5	1	9205430000
REMOVAL TOOL HD	1	1866730000

Female

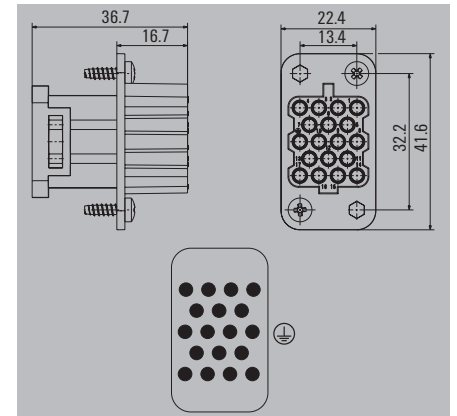

Ordering data

Type of connection	Type	Qty.	Order No.
Crimp connection	HDC HQ 17 FC	1	1003200000

Accessories

Type	Qty.	Order No.
Crimp contacts, female - gold		
HDC-C-HD-BM0.14-0.37AU	100	1651670000
HDC-C-HD-BM0.5AU	100	1651680000
HDC-C-HD-BM0.75-1.00AU	100	1651690000
HDC-C-HD-BM1.5AU	100	1651700000
HDC-C-HD-BM2.5AU	100	1651710000
Crimp contacts, female - silver		
HDC-C-HD-BM0.14-0.37AG	100	1651570000
HDC-C-HD-BM0.5AG	100	1651580000
HDC-C-HD-BM0.75-1.00AG	100	1601760000
HDC-C-HD-BM1.5AG	100	1651600000
HDC-C-HD-BM2.5AG	100	1651610000
Tools		
CTX CM 1.6/2.5	1	9018490000
CTIN CM 1.6/2.5	1	9205430000
REMOVAL TOOL HD	1	1866730000

Installation cut-out

Housing selection RockStar® IP65
Size HQ

Hood

Plug housing, cable entry sideways



Material: Zinc diecast

a	Version	Cover	b (mm)	Type	Order No.
PG 21	w. thread		60.5	HDC HQM TSLU 1PG21	1003100000

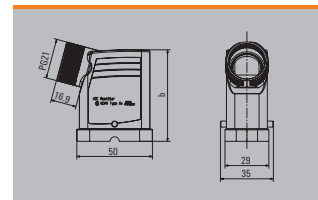

Plug housing, cable entry at top



Material: Zinc diecast

a	Version	Cover	b (mm)	Type	Order No.
PG 21	w. thread		77.5	HDC HQM TOLU 1PG21	1003080000

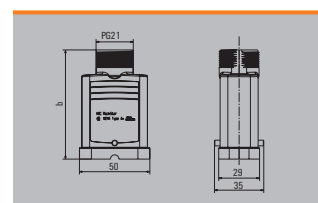

Base

Bulkhead housing



Material: Zinc diecast

Version	Cover	b (mm)	Type	Order No.
Side-locking		20.5	HDC HQM ALU	1003050000

Note CS: with lockable lever

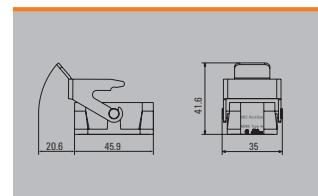

Cover



Material: Plastic

Version	Type	Order No.
with female	HDC HQP DMD 2B0	1003130000
with male	HDC HQP DOD 2B0	1003140000

Note for plastic and metal housings, with lockable lever

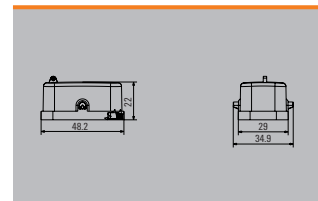

690 V / 250 V, 10 A / 40 A, size HQ

4 + 2 + ⊕

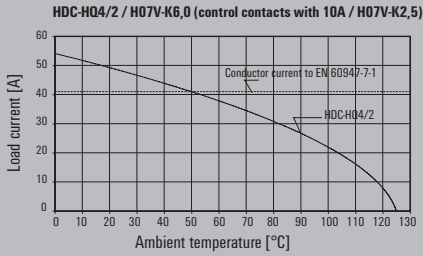

Male

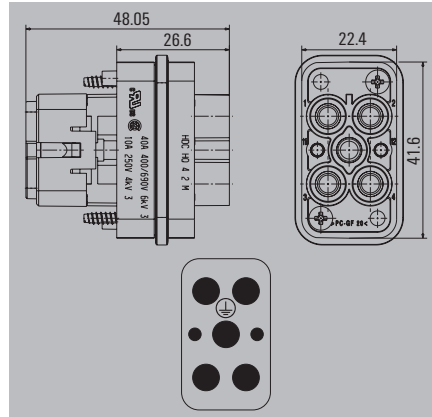

Ordering data

Type of connection	Type	Qty.	Order No.
Crimp connection	HDC HQ 4/2 MC	1	1003170000

For complete assembly you need four HX contacts and two HD contacts

Accessories

Type	Qty.	Order No.
Crimp contacts, male - gold		
HDC-C-HD-SM0.14-0.37AU	100	1651620000
HDC-C-HD-SM0.5AU	100	1651630000
HDC-C-HD-SM0.75-1.00AU	100	1651640000
HDC-C-HD-SM1.5AU	100	1651650000
HDC-C-HD-SM2.5AU	100	1651660000
Crimp contacts, male - silver		
HDC-C-HD-SM0.14-0.37AG	100	1651520000
HDC-C-HD-SM0.5AG	100	1651530000
HDC-C-HD-SM0.75-1.00AG	100	1601750000
HDC-C-HD-SM1.5AG	100	1651550000
HDC-C-HD-SM2.5AG	100	1651560000
HDC C HX SM1.5AG	25	1002910000
HDC C HX SM2.5AG	25	1002920000
HDC C HX SM4.0AG	25	1002930000
HDC C HX SM6.0AG	25	1002940000
Tools		
CTX CM 1.6/2.5	1	9018490000
CTIN CM 1.6/2.5	1	9205430000
REMOVAL TOOL HD	1	1866730000
REMOVAL TOOL HX	1	1002990000

Female

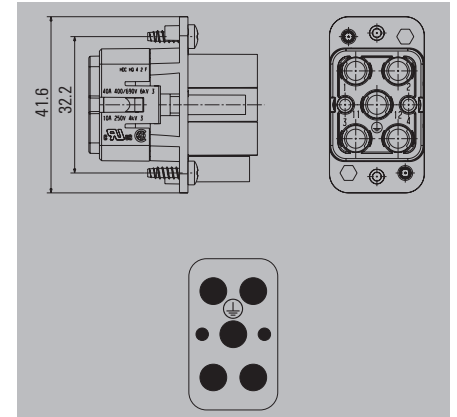

Ordering data

Type of connection	Type	Qty.	Order No.
Crimp connection	HDC HQ 4/2 FC	1	1003160000

For complete assembly you need four HX contacts and two HD contacts

Accessories

Type	Qty.	Order No.
Crimp contacts, female - gold		
HDC-C-HD-BM0.14-0.37AU	100	1651670000
HDC-C-HD-BM0.5AU	100	1651680000
HDC-C-HD-BM0.75-1.00AU	100	1651690000
HDC-C-HD-BM1.5AU	100	1651700000
HDC-C-HD-BM2.5AU	100	1651710000
Crimp contacts, female - silver		
HDC-C-HD-BM0.14-0.37AG	100	1651570000
HDC-C-HD-BM0.5AG	100	1651580000
HDC-C-HD-BM0.75-1.00AG	100	1601760000
HDC-C-HD-BM1.5AG	100	1651600000
HDC-C-HD-BM2.5AG	100	1651610000
HDC C HX BM1.5AG	25	1002950000
HDC C HX BM2.5AG	25	1002960000
HDC C HX BM4.0AG	25	1002970000
HDC C HX BM6.0AG	25	1002980000
Tools		
CTX CM 1.6/2.5	1	9018490000
CTIN CM 1.6/2.5	1	9205430000
REMOVAL TOOL HD	1	1866730000
REMOVAL TOOL HX	1	1002990000

Installation cut-out



**Housing selection RockStar® IP65
Size HQ**

Hood

Plug housing, cable entry sideways



a	Version	Cover	b (mm)	Type	Order No.
PG 16	w. thread		54	HDC HQP TSLU 1PG16	1003090000

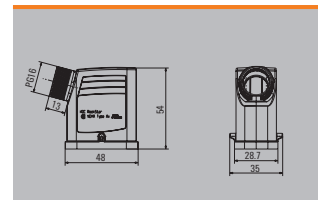

Plug housing, cable entry at top



a	Version	Cover	b (mm)	Type	Order No.
PG 16	w. thread		67	HDC HQP TOLU 1PG16	1003070000

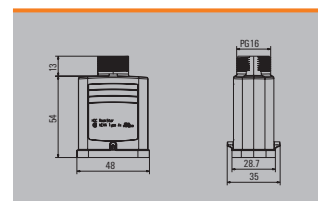

Base

Bulkhead housing



Version	Cover	b (mm)	Type	Order No.
Side-locking		19.5	HDC HQP ALU	1003040000

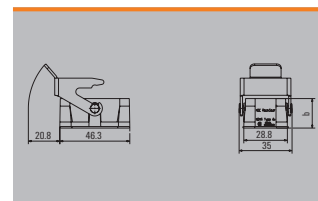

Note CS: with lockable lever

Bulkhead housing for FieldPower Box



Version	Cover	b (mm)	Type	Order No.
			BG ARGH HQP ALU PT6	1532200000
			BG ARGH HQP ALU PT6 CS	1532210000



Note CS: with locking bow

Bulkhead housing angled



Version	Cover	b (mm)	Type	Order No.
Side-locking		54.5	HDC HQP AWLU	1003060000

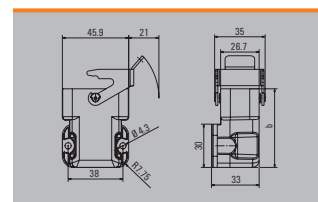

Base housing



a	Version	Cover	b (mm)	Type	Order No.
PG 16	Side-locking		54.5	HDC HQP SLU 1PG16	1003110000

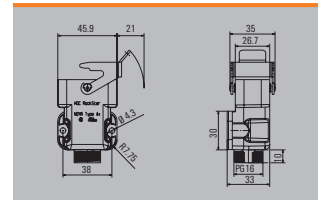

Coupling housing



a	Version	Cover	b (mm)	Type	Order No.
PG 16	w. thread		63.5	HDC HQP KOLU 1PG16	1003120000

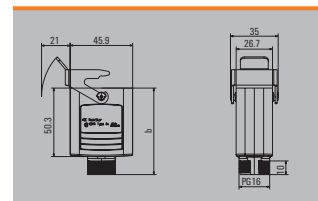

MixMate series

Multifunctional: The special design of MixMate enables reliable transmission of high rated currents and voltages, as well as signals, simultaneously.

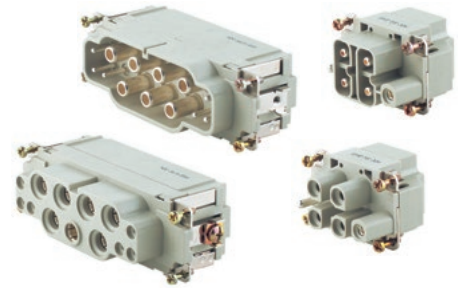





















Technical data

	S4	S8/24	S4/0	S4/2
Standards/approvals				
Standards	DIN EN 61984 DIN EN 60664-1	DIN EN 61984 DIN EN 60664-1	DIN EN 61984 DIN EN 60664-1	DIN EN 61984 DIN EN 60664-1
Approvals	UL/CSA	UL/CSA/VDE	UL/CSA/VDE	UL/CSA/VDE
Inserts				
No. of poles				
- Power contact	4 (+ PE)	8 (+ PE)	4 (+ PE)	4 (+ PE)
- Signal contact		24		2
Rated voltage				
- Power contact	1,000 V	400 V	830 V	830 V
- Signal contact		160 V		400 V
Rated voltage to UL/CSA	600 V	600 V	600 V	600 V
Rated current				
- Power contact	40 A	16 A	80 A	80 A
- Signal contact		10 A		16 A
Rated impulse withstand voltage				
- Power contact	8 kV	4 kV	8 kV	8 kV
- Signal contact		2.5 kV		6 kV
Pollution severity	3	3	3	3
Insulation resistance	$\geq 10^{10} \Omega$	$\geq 10^{10} \Omega$	$\geq 10^{10} \Omega$	$\geq 10^{10} \Omega$
Material	Glass-fibre reinforced PC (in UL list and approved for railway applications)	Glass-fibre reinforced PC (in UL list and approved for railway applications)	Glass-fibre reinforced PC (in UL list and approved for railway applications)	Glass-fibre reinforced PC (in UL list and approved for railway applications)
Temperature range	-40 °C to +125 °C	-40 °C to +125 °C	-40 °C to +125 °C	-40 °C to +125 °C
Flammability to UL 94	V-0	V-0	V-0	V-0
Mechanical service life				
- Plugging cycles Ag-Surface	≥ 500	≥ 500	≥ 500	≥ 500
- Plugging cycles Au-Surface		≥ 500		
Contact resistance with min. and max. conductors	$\leq 1 \text{ m}\Omega$	$\leq 2 \text{ m}\Omega$ (Power) $\leq 4 \text{ m}\Omega$ (Signals)	$\leq 1 \text{ m}\Omega$	$\leq 1 \text{ m}\Omega$ (Power) $\leq 2 \text{ m}\Omega$ (Signals)
Contacts / Material				
Sockets and plug-in contact	Copper alloy	Copper alloy	Copper alloy	Copper alloy
Surface	Passivated silver	Passivated silver or gold-plated	Passivated silver	Passivated silver
Flexible conductor connection				
- Power contact	2.5 - 10 mm ² (AWG 14 - 8)	0.5 - 4 mm ² (AWG 20 - 12)	1.5 - 16 mm ² (AWG 16 - 6)	1.5 - 16 mm ² (AWG 16 - 6)
- Signal contact		0.14 - 2.5 mm ² (AWG 26 - 14)		0.5 - 2.5 mm ² (AWG 22 - 14)
Stripping length				
- Power contact	8 mm	7.5 mm	15 mm	15 mm
- Signal contact		8 mm		8 mm
Clamping torque				
- Power contact	1.1 - 1.7 Nm		1.2 Nm (1.5 mm ²) / 2 Nm (2.5 mm ²) / 3 Nm (4 - 16 mm ²)	1.2 Nm (1.5 mm ²) / 2 Nm (2.5 mm ²) / 3 Nm (4 - 16 mm ²)
- Signal contact				0.5 - 0.55 Nm
Tools				
- Hexagon socket, 2 mm	SW 2			
- Screwdriver	0.6 x 3.5 mm		SD 0.8 x 4 mm	SD 0.8 x 4 mm (Power) / SD 0.6 x 3.5 mm or PH1 (Signals)
- Crimping tool		CTIN 1.6/2.5 / CTX CM 1.6/2.5 (for 0.5 - 1.5 mm ²)		
PE connection via plug/socket				
- Clamping range	1.5/2.5 - 4/10 mm ²	0.5 - 6 mm ² (0.5 mm ² with ferrule)	0.5 - 16 mm ² (0.5 mm ² with ferrule 10 - 16 mm ² with ring cable lug)	0.5 - 16 mm ² (0.5 mm ² with ferrule 10 - 16 mm ² with ring cable lug)
- AWG conductor	AWG 16/14 - 12/8	AWG 20 - 10 (AWG 10 with ring cable lug)	AWG 20 - 6 (AWG 10. 8 and 6 with ring cable lug)	AWG 20 - 6 (AWG 10. 8 and 6 with ring cable lug)
- Stripping length	8 mm	13 mm	13 mm	13 mm
- Clamping torque	0.5 - 0.8 Nm	2 - 2.5 Nm	2 - 2.5 Nm	2 - 2.5 Nm
- Blade dimensions	SD 0.8 x 4 mm	SD 1.2 x 6.5 mm or PH2	SD 1.2 x 6.5 mm or PH2	SD 1.2 x 6.5 mm or PH2

Hinweis: When used properly and as designated, the listed connectors may not be connected or disconnected if there is a live voltage or load!
* Power contact = Axial screw connection, Signal contact = Screw connection

S6/12*	S6/36	S12/2	S4/8	S6/6*	S8/0
DIN EN 61984 DIN EN 60664-1 UL/CSA	DIN EN 61984 DIN EN 60664-1 UL/CSA/VDE	DIN EN 61984 DIN EN 60664-1 UL/CSA/VDE	DIN EN 61984 DIN EN 60664-1 UL/CSA/VDE	DIN EN 61984 DIN EN 60664-1 UL/CSA	DIN EN 61984 DIN EN 60664-1 UL/CSA/VDE
6 (+ PE) 12	6 (+ PE) 36	12 (+ PE) 2	4 (+ PE) 8	6 (+ PE) 6	8 (+ PE x 2)
690 V 400 V 600 V	690 V 160 V 600 V	690 V 250 V 600 V	400 V 400 V 600 V	690 V 400 V 600 V	690 V 400 V 600 V
48 A 16 A	40 A 10 A	40 A 10 A	80 A 16 A	100 A 16 A	110 A
8 kV 6 kV 3	8 kV 2.5 kV 3	8 kV 4 kV 3	6 kV 6 kV 3	8 kV 6 kV 3	8 kV 6 kV 3
≥ 10 ¹⁰ Ω	≥ 10 ¹⁰ Ω	≥ 10 ¹⁰ Ω	≥ 10 ¹⁰ Ω	≥ 10 ¹⁰ Ω	≥ 10 ¹⁰ Ω
Glass-fibre reinforced PC (in UL list and approved for railway applications) -40 °C to +125 °C V-0	Glass-fibre reinforced PC (in UL list and approved for railway applications) -40 °C to +125 °C V-0	Glass-fibre reinforced PC (in UL list and approved for railway applications) -40 °C to +125 °C V-0	Glass-fibre reinforced PC (in UL list and approved for railway applications) -40 °C to +125 °C V-0	Glass-fibre reinforced PC (in UL list and approved for railway applications) -40 °C to +125 °C V-0	Glass-fibre reinforced PC (in UL list and approved for railway applications) -40 °C to +125 °C V-0
≥ 500	≥ 500 ≥ 500	≥ 500 ≥ 500	≥ 500	≥ 500	≥ 500
≤ 2 mΩ (Power) ≤ 2 mΩ (Signals)	≤ 2 mΩ (Power) ≤ 4 mΩ (Signals)	≤ 2 mΩ (Power) ≤ 4 mΩ (Signals)	≤ 1 mΩ (Power) ≤ 2 mΩ (Signals)	≤ 1 mΩ (Power) ≤ 2 mΩ (Signals)	≤ 1 mΩ
Copper alloy Passivated silver	Copper alloy Passivated silver or gold-plated	Copper alloy Passivated silver or gold-plated	Copper alloy Passivated silver	Copper alloy Passivated silver	Copper alloy Passivated silver
2.5 - 10 mm ² (AWG 14 - 8) 0.5 - 2.5 mm ² (AWG 24 - 14)	1.5 - 6 mm ² (AWG 16 - 10) 0.14 - 2.5 mm ² (AWG 26 - 14)	1.5 - 6 mm ² (AWG 16 - 10) 0.14 - 2.5 mm ² (AWG 26 - 14)	1.5 - 16 mm ² (AWG 16 - 6) 0.5 - 2.5 mm ² (AWG 22 - 14)	16 - 35 mm ² (AWG 6 - 2) 0.5 - 2.5 mm ² (AWG 24 - 14)	10 - 25 mm ² (AWG 8 - 4)
8 mm 12 mm	9 mm 8 mm	9 mm 8 mm	15 mm 8 mm	13 mm 12 mm	12 mm
1.1 - 1.7 Nm			1.2 Nm (1.5 mm ²) / 2 Nm (2.5 mm ²) / 3 Nm (4 - 16 mm ²)	6 - 8 Nm	6 Nm (10 - 16 mm ²) / 7 Nm (25 mm ²)
0.45 - 0.9 Nm			0.5 - 0.55 Nm	0.45 - 0.9 Nm	
SW 2 0.6 x 3.5 mm			SD 0.8 x 4 mm (Power) / SD 0.6 x 3.5 mm or PH1 (Signals)	SW 4 SD 0.6 x 3.5 or PZ 0	SW 4
	CTIN 1.6/2.5 / CTX CM 1.6/2.5 (for 0.5 - 1.5 mm ²)	CTIN 1.6/2.5 / CTX CM 1.6/2.5 (for 0.5 - 1.5 mm ²)			
2.5 - 10 mm ²	0.5 - 6 mm ² (0.5 mm ² with ferrule)	0.5 - 6 mm ² (0.5 mm ² with ferrule)	0.5 - 16 mm ² (0.5 mm ² with ferrule), 10 - 16 mm ² with ring cable lug	16 - 35 mm ²	10 - 25 mm ²
AWG 14 - 8	AWG 20 - 10 (AWG 10 with ring cable lug)	AWG 20 - 10 (AWG 10 with ring cable lug)	AWG 20 - 6 (AWG 10.8 and 6 with ring cable lug)	AWG 6 - 2	AWG 8 - 4
8 mm	13 mm	13 mm	13 mm	8 mm	12 mm
2 - 2.5 Nm	2 - 2.5 Nm	2 - 2.5 Nm	2 - 2.5 Nm	6 - 8 Nm	6 Nm (10 - 16 mm ²) / 7 Nm (25 mm ²)
SD 0.8 x 4 mm or PZ2	SD 1.2 x 6.5 mm or PH2	SD 1.2 x 6.5 mm or PH2	SD 1.2 x 6.5 mm or PH2	SD 0.8 x 4 mm or PZ 1	SD 5.5 x 1.0 or PH2

Overview

		Size	Rated voltage	Rated current	No. of poles	Tension clamp connection	TOP connection	Screw conn. with wire guard spring	Crimp connection	Axial screw connection	Page
		3	1,000 V	40 A	4 + ⊕					•	B.116
		4	400 V	16 A	8 + 24 + ⊕				•		B.118
		6	830 V	80 A	4 + 0 + ⊕			•			B.120
		6	830 V	80 A	4 + 2 + ⊕			•			B.122
		6	690 V	40 A	6 + 36 + ⊕				•		B.124
		6	690 V	48 A	6 + 12 + ⊕			•		•	B.126
		6	690 V	40 A	12 + 2 + ⊕				•		B.128
		8	400 V	80 A	4 + 8 + ⊕			•			B.130
		8	690 V	100 A	6 + 6 + ⊕			•		•	B.132
		8	690 V	110 A	8 + 0 + ⊕					•	B.134

1000 V, 40 A, size 3

4 + ⊕

HDC S4 / Power contact: H07V-K10

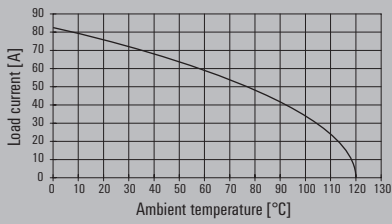

Male

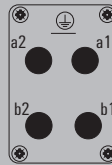
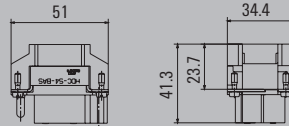

Female

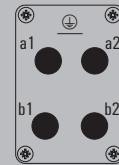
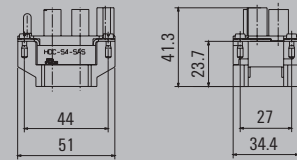

Ordering data

Type of connection	Type	Qty.	Order No.
Axial screw connection	HDC S4 SAS	1	1789990000

Combine these inserts only with housings with a high design (Size 16D).

Ordering data

Type of connection	Type	Qty.	Order No.
Axial screw connection	HDC S4 BAS	1	1789980000

Combine these inserts only with housings with a high design (Size 16D).

Installation cut-out

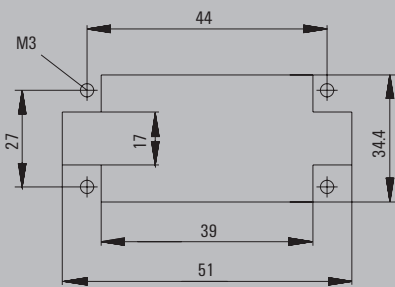

Housing selection RockStar® IP65
Size 3



For additional housings, refer to
Chapter D for IP65 / Chapter E for IP65 EMC /
Chapter F for IP68 EMC

Hood

Plug housing, cable entry sideways



a	Version	Cover	b (mm)	Type	Order No.
M 25	w. thread		72	HDC 16D TSLU 1M25G	1787480000
M 32	w. thread		72	HDC 16D TSLU 1M32G	1787470000

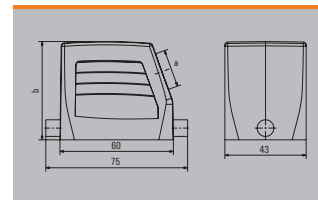

Plug housing, cable entry at top



a	Version	Cover	b (mm)	Type	Order No.
M 25	w. thread		72	HDC 16D TOLU 1M25G	1787500000
M 32	w. thread		72	HDC 16D TOLU 1M32G	1787490000

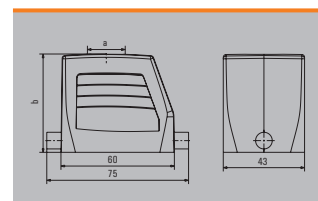

Cover



Version	Type	Order No.
For hoods	HDC 06B DMDL 1LB	1665210000
For hoods	HDC 06B DMDL 1LB N	2559730000

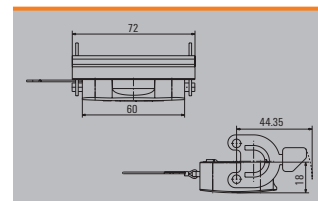

Note: N = Plastic locking lever with stainless steel inlay

Base

Bulkhead housing



Version	Cover	b (mm)	Type	Order No.
	without cover	29.3	HDC 06B ALU	1202100000
		29.3	HDC 06B ALU N	2488560000
	with cover	29.3	HDC 06B ADLU	1202500000
	with cover	29.3	HDC 06B ADLU N	2559320000

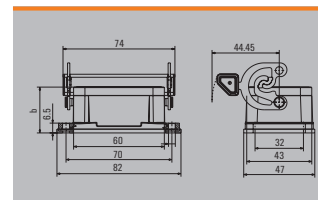

Note: N = Plastic locking lever with stainless steel inlay

Base housing



a	Version	Cover	b (mm)	Type	Order No.
M 25	End-locking		74	HDC 16D SLU 2M25G	1787520000
M 25	End-locking	with cover	74	HDC 16D SDLU 2M25G	1787540000
M 32	End-locking		74	HDC 16D SLU 2M32G	1787510000

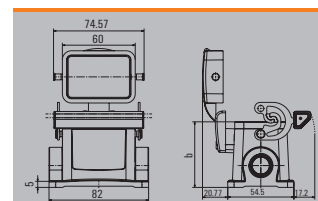

Cover



Version	Type	Order No.
For bases	HDC 06B DDDL 2B0	1665200000

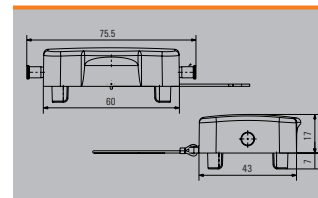

400 V, 16 A, size 4

8 + 24 + ⊕

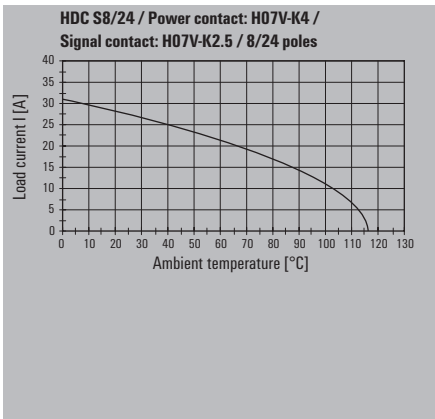

Installation cut-out

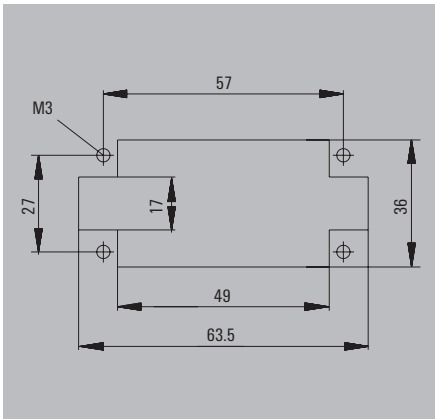

Male

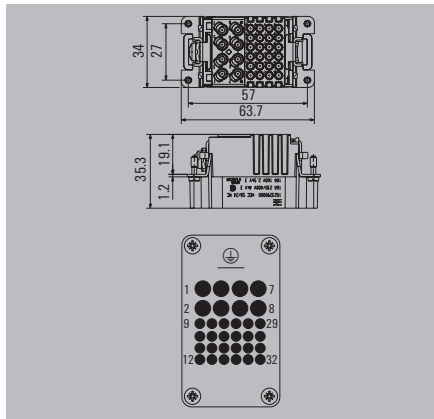
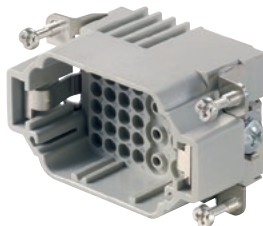

Ordering data

Type of connection	Type	Qty.	Order No.
Crimp connection	HDC S8/24 MC	1	1023290000

The signal contacts are designed for a rated voltage of 160 V and a rated current of 10 A.

Accessories

Type	Qty.	Order No.
Crimp contacts, male - gold		
HDC-C-HE-SM0.5AU	100	1651420000
HDC-C-HE-SM0.75-1.00AU	100	1651430000
HDC-C-HE-SM1.5AU	100	1651440000
HDC-C-HE-SM2.5AU	100	1651450000
HDC-C-HE-SM4.0AU	100	1651460000
HDC-C-HD-SM0.14-0.37AU	100	1651620000
HDC-C-HD-SM0.5AU	100	1651630000
HDC-C-HD-SM0.75-1.00AU	100	1651640000
HDC-C-HD-SM1.5AU	100	1651650000
HDC-C-HD-SM2.5AU	100	1651660000
Crimp contacts, male - silver		
HDC-C-HE-SM0.5AG	100	1200500000
HDC-C-HE-SM0.75-1.00AG	100	1200600000
HDC-C-HE-SM1.5AG	100	1200700000
HDC-C-HE-SM2.5AG	100	1200800000
HDC-C-HE-SM4.0AG	100	1200900000
HDC-C-HD-SM0.14-0.37AG	100	1651520000
HDC-C-HD-SM0.5AG	100	1651530000
HDC-C-HD-SM0.75-1.00AG	100	1601750000
HDC-C-HD-SM1.5AG	100	1651550000
HDC-C-HD-SM2.5AG	100	1651560000
Tools		
CTIN CM 1.6/2.5	1	9205430000
REMOVAL TOOL HE	1	1866750000
REMOVAL TOOL HD	1	1866730000

Female

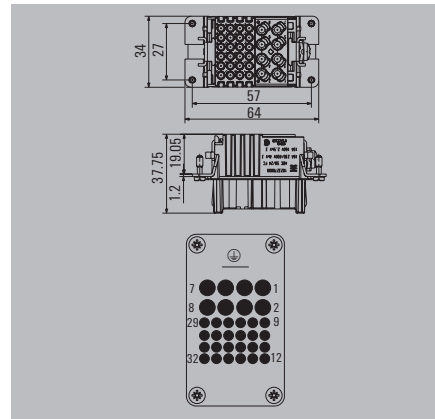

Ordering data

Type of connection	Type	Qty.	Order No.
Crimp connection	HDC S8/24 FC	1	1023270000

The signal contacts are designed for a rated voltage of 160 V and a rated current of 10 A.

Accessories

Type	Qty.	Order No.
Crimp contacts, female - gold		
HDC-C-HE-BM0.5AU	100	1651470000
HDC-C-HE-BM0.75-1.00AU	100	1651480000
HDC-C-HE-BM1.5AU	100	1651490000
HDC-C-HE-BM2.5AU	100	1651500000
HDC-C-HE-BM4.0AU	100	1651510000
HDC-C-HD-BM0.14-0.37AU	100	1651670000
HDC-C-HD-BM0.5AU	100	1651680000
HDC-C-HD-BM0.75-1.00AU	100	1651690000
HDC-C-HD-BM1.5AU	100	1651700000
HDC-C-HD-BM2.5AU	100	1651710000
Crimp contacts, female - silver		
HDC-C-HE-BM0.5AG	100	1201100000
HDC-C-HE-BM0.75-1.00AG	100	1201200000
HDC-C-HE-BM1.5AG	100	1201300000
HDC-C-HE-BM2.5AG	100	1201400000
HDC-C-HE-BM4.0AG	100	1201500000
HDC-C-HD-BM0.14-0.37AG	100	1651570000
HDC-C-HD-BM0.5AG	100	1651580000
HDC-C-HD-BM0.75-1.00AG	100	1601760000
HDC-C-HD-BM1.5AG	100	1651600000
HDC-C-HD-BM2.5AG	100	1651610000
Tools		
CTIN CM 1.6/2.5	1	9205430000
REMOVAL TOOL HE	1	1866750000
REMOVAL TOOL HD	1	1866730000

Housing selection RockStar® IP65
Size 4



For additional housings, refer to
Chapter D for IP65 / Chapter E for IP65 EMC /
Chapter F for IP68 EMC

Hood

Plug housing, cable entry sideways



a	Version	Cover	b (mm)	Type	Order No.
M 20	w. thread		52	HDC 10B TSBU 1M20G	1787560000
M 25	w. thread		52	HDC 10B TSBU 1M25G	1787550000
M 25	w. thread		72	HDC 24D TSBU 1M25G	1787240000
M 32	w. thread		72	HDC 24D TSBU 1M32G	1787230000

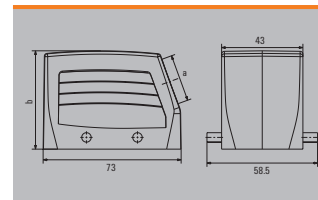

Plug housing, cable entry at top



a	Version	Cover	b (mm)	Type	Order No.
M 20	w. thread		52	HDC 10B TOBU 1M20G	1787600000
M 25	w. thread		52	HDC 10B TOBU 1M25G	1787590000
M 25	w. thread		72	HDC 24D TOBU 1M25G	1787300000
M 32	w. thread		72	HDC 24D TOBU 1M32G	1787290000

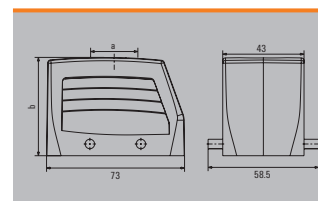

Cover



Version	Type	Order No.
For hoods	HDC 10B DMDQ 2QB	1665240000
For hoods	HDC 10B DMDQ 2QB N	2559740000

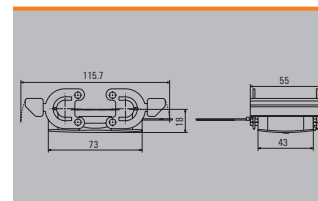

Note: N = Plastic locking lever with stainless steel inlay

Base

Bulkhead housing



Version	Cover	b (mm)	Type	Order No.
		29.5	HDC 10B ABU	1205000000
		29.5	HDC 10B ABU N	2488580000

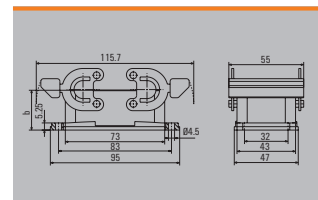

Note: N = Plastic locking lever with stainless steel inlay

Base housing



a	Version	Cover	b (mm)	Type	Order No.
M 20	Side-locking		57	HDC 10B SBU 1M20G N	2560880000
M 20	Side-locking		57	HDC 10B SBU 2M20G	1787640000
M 20	Side-locking		57	HDC 10B SBU 2M20G N	2560890000
M 25	Side-locking		57	HDC 10B SBU 1M25G N	2560900000
M 25	Side-locking		57	HDC 10B SBU 2M25G	1787630000
M 25	Side-locking		57	HDC 10B SBU 2M25G N	2560910000

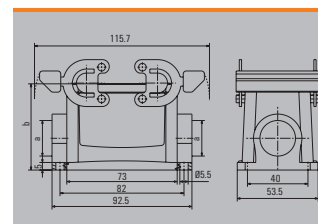

Note: N = Plastic locking lever with stainless steel inlay

Coupling housing



a	Version	Cover	b (mm)	Type	Order No.
M 20	w. thread		54.65	HDC 10B KBU 1M20G	1787720000
M 20	w. thread		54.65	HDC 10B KBU 1M20G N	2559860000

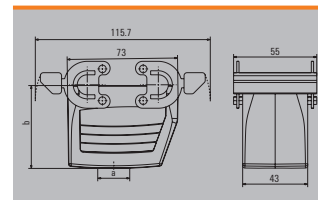

Note: N = Plastic locking lever with stainless steel inlay

Cover



Version	Type	Order No.
For bases	HDC 10B DDDQ 4B0	1665230000

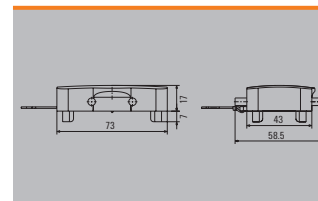

830 V, 80 A, size 6

4 + 0 + ⊕

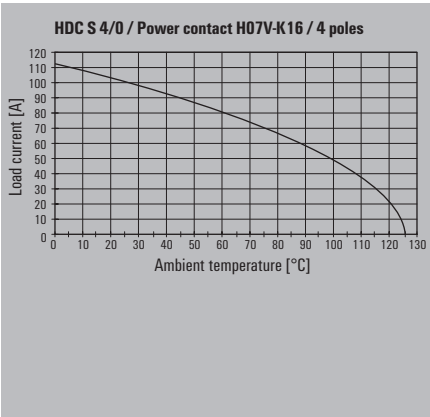

Male

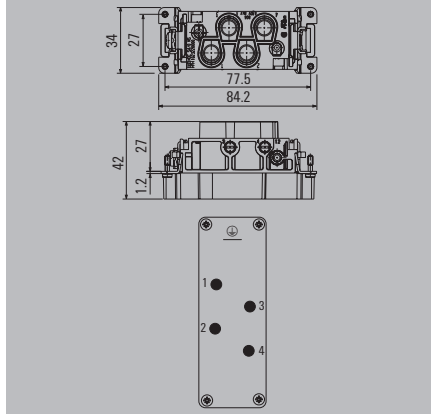
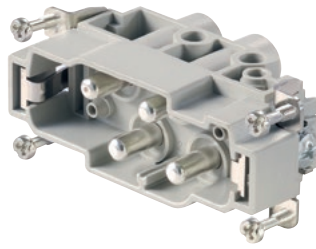

Ordering data

Type of connection	Type	Qty.	Order No.
Screw connection	HDC S4/0 MS	1	1023220000

Female

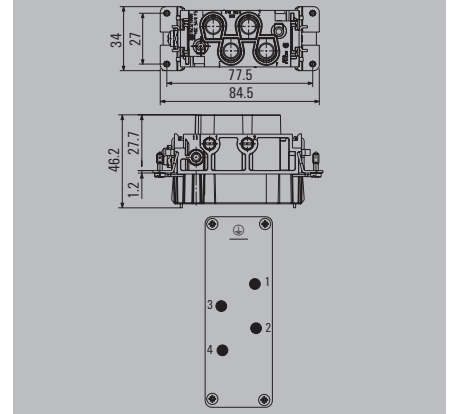
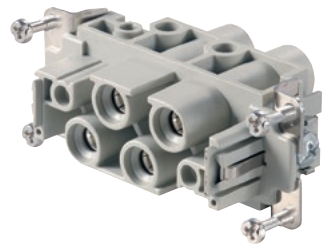

Ordering data

Type of connection	Type	Qty.	Order No.
Screw connection	HDC S4/0 FS	1	1023210000

Installation cut-out

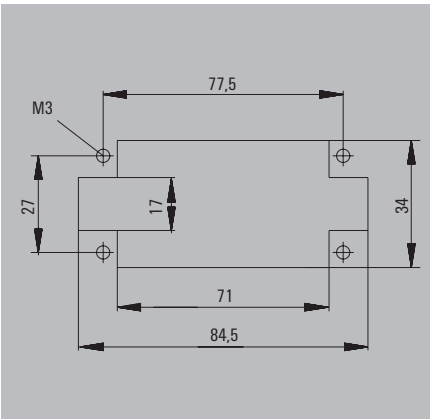

Housing selection RockStar® IP65
Size 6



For additional housings, refer to
Chapter D for IP65 / Chapter E for IP65 EMC /
Chapter F for IP68 EMC

Hood

Plug housing, cable entry sideways



a	Version	Cover	b (mm)	Type	Order No.
M 25	w. thread		61	HDC 16B TSBU 1M25G	1788180000
M 25	w. thread		76	HDC 40D TSBU 1M25G	1787010000
M 32	w. thread		76	HDC 40D TSBU 1M32G	1787000000

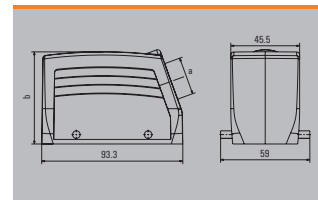

Plug housing, cable entry at top



a	Version	Cover	b (mm)	Type	Order No.
M 25	w. thread		61	HDC 16B TOBU 1M25G	1788210000
M 25	w. thread		76	HDC 40D TOBU 1M25G	1787070000
M 32	w. thread		76	HDC 40D TOBU 1M32G	1787060000

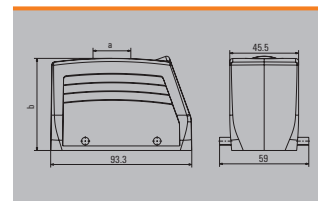

Cover



Version	Type	Order No.
For hoods	HDC 16B DMDQ 2QB	1665270000

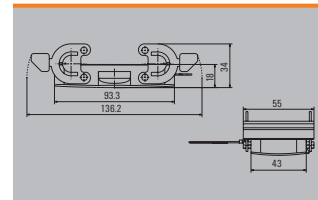

Base

Bulkhead housing



Version	Cover	b (mm)	Type	Order No.
		29	HDC 16B ABU	1208600000
		29	HDC 16B ABU N	2488590000

Note: N = Plastic locking lever with stainless steel inlay

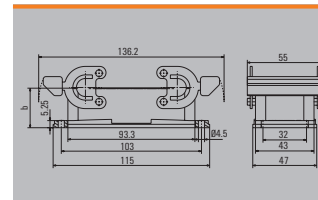

Base housing



a	Version	Cover	b (mm)	Type	Order No.
M 25	Side-locking		64	HDC 16B SBU 1M25G N	2560740000
M 25	Side-locking		64	HDC 16B SBU 2M25G	1788240000
M 25	Side-locking		64	HDC 16B SBU 2M25G N	2560930000
M 25	Side-locking		84	HDC 40D SBU 2M25G	1787120000
PG 21	Side-locking		84	HDC 40D SBU 1M32G N	2561030000
M 32	Side-locking		84	HDC 40D SBU 2M32G	1787110000

Note: N = Plastic locking lever with stainless steel inlay

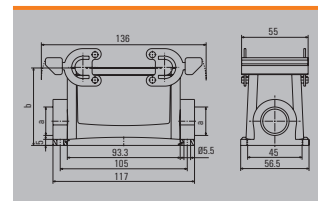

Coupling housing



a	Version	Cover	b (mm)	Type	Order No.
M 25	w. thread		78.6	HDC 40D KBU 1M25G	1787200000
PG 29	w. thread		79	HDC 40D KBU 1M25G N	2559890000
M 32	w. thread		78.6	HDC 40D KBU 1M32G	1787190000
PG 29	w. thread		79	HDC 40D KBU 1M32G N	2559900000
PG 29	w. thread		79	HDC 40D KBU 2M32G N	2545510000

Note: N = Plastic locking lever with stainless steel inlay

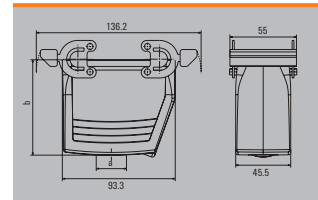

Cover



Version	Type	Order No.
For bases	HDC 16B DDDQ 480	1665260000

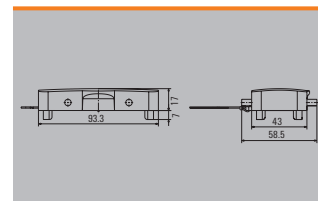

MixMate series

830 V, 80 A, size 6

4 + 2 + ⊕

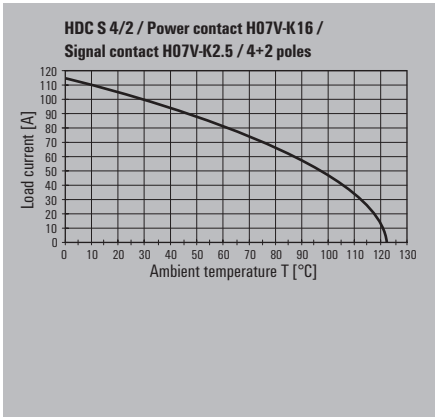

Male

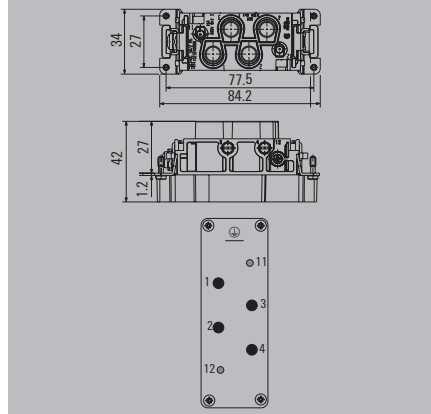
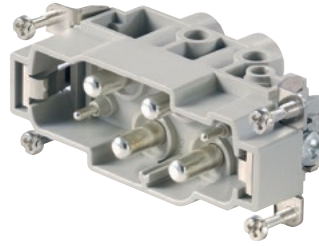

Ordering data

Type of connection	Type	Qty.	Order No.
Screw connection	HDC S4/2 MS	1	1023240000

The signal contacts are designed for a rated voltage of 400V and a rated current of 16A.

Female

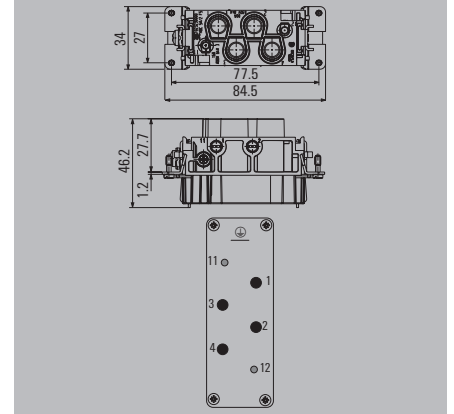
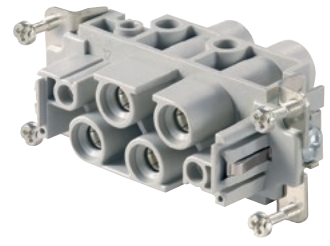

Ordering data

Type of connection	Type	Qty.	Order No.
Screw connection	HDC S4/2 FS	1	1023230000

The signal contacts are designed for a rated voltage of 400V and a rated current of 16A.

Installation cut-out

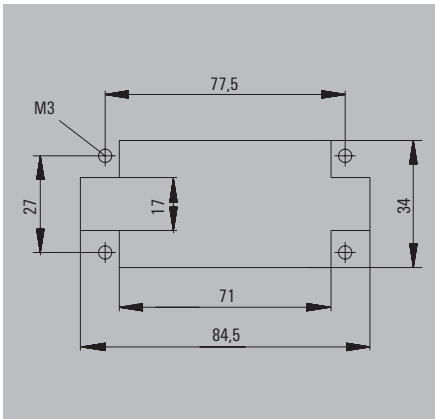

Housing selection RockStar® IP65
Size 6

 For additional housings, refer to
Chapter D for IP65 / Chapter E for IP65 EMC /
Chapter F for IP68 EMC

Hood

Plug housing, cable entry sideways



a	Version	Cover	b (mm)	Type	Order No.
M 25	w. thread		61	HDC 16B TSBU 1M25G	1788180000
M 25	w. thread		76	HDC 40D TSBU 1M25G	1787010000
M 32	w. thread		76	HDC 40D TSBU 1M32G	1787000000

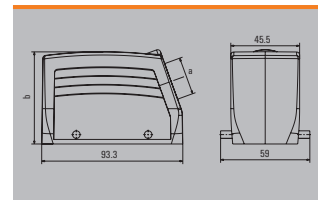

Plug housing, cable entry at top



a	Version	Cover	b (mm)	Type	Order No.
M 25	w. thread		61	HDC 16B TOBU 1M25G	1788210000
M 25	w. thread		76	HDC 40D TOBU 1M25G	1787070000
M 32	w. thread		76	HDC 40D TOBU 1M32G	1787060000

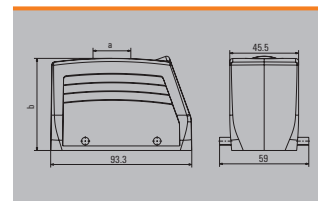

Cover



Version	Type	Order No.
For hoods	HDC 16B DMDQ 2QB	1665270000

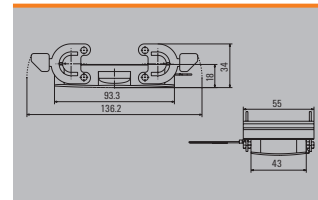

Base

Bulkhead housing



Version	Cover	b (mm)	Type	Order No.
		29	HDC 16B ABU	1208600000
		29	HDC 16B ABU N	2488590000

Note: N = Plastic locking lever with stainless steel inlay

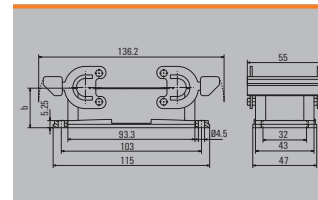

Base housing



a	Version	Cover	b (mm)	Type	Order No.
M 25	Side-locking		64	HDC 16B SBU 1M25G N	2560740000
M 25	Side-locking		64	HDC 16B SBU 2M25G	1788240000
M 25	Side-locking		64	HDC 16B SBU 2M25G N	2560930000
M 25	Side-locking		84	HDC 40D SBU 2M25G	1787120000
PG 21	Side-locking		84	HDC 40D SBU 1M32G N	2561030000
M 32	Side-locking		84	HDC 40D SBU 2M32G	1787110000

Note: N = Plastic locking lever with stainless steel inlay

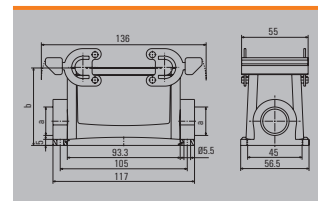

Coupling housing



a	Version	Cover	b (mm)	Type	Order No.
M 25	w. thread		78.6	HDC 40D KBU 1M25G	1787200000
PG 29	w. thread		79	HDC 40D KBU 1M25G N	2559890000
M 32	w. thread		78.6	HDC 40D KBU 1M32G	1787190000
PG 29	w. thread		79	HDC 40D KBU 1M32G N	2559900000
PG 29	w. thread		79	HDC 40D KBU 2M32G N	2545510000

Note: N = Plastic locking lever with stainless steel inlay

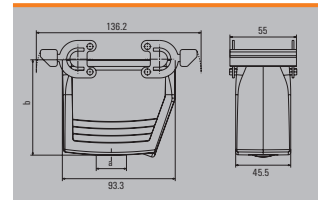

Cover



Version	Type	Order No.
For bases	HDC 16B DDDQ 480	1665260000

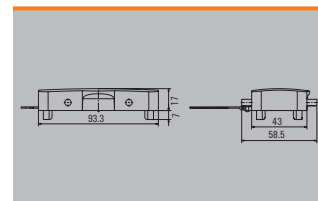

690 V, 40 A, size 6

6 + 36 + ⊕

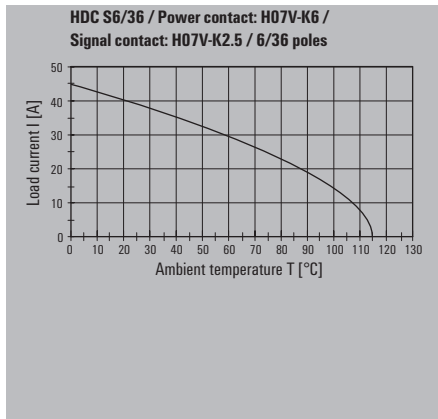

Installation cut-out

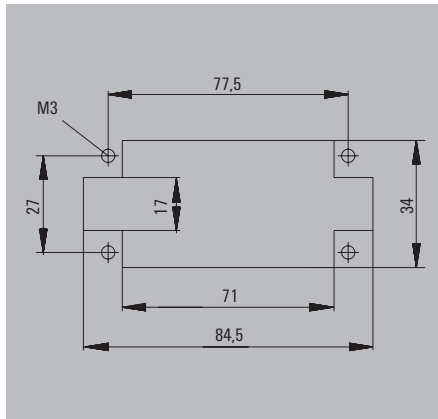

Male

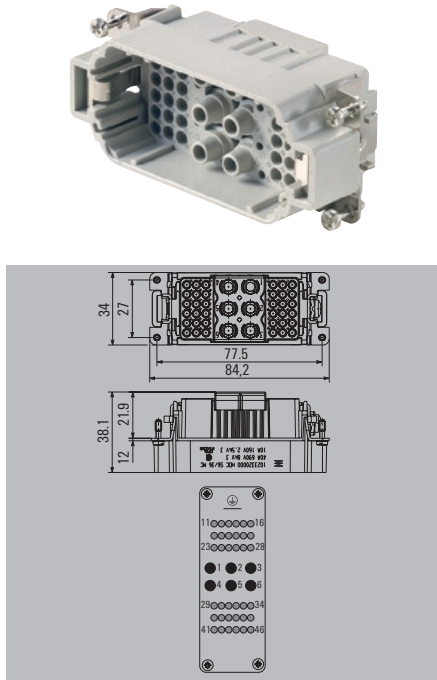

Ordering data

Type of connection	Type	Qty.	Order No.
Crimp connection	HDC S6/36 MC	1	1023320000

The signal contacts are designed for a rated voltage of 160 V and a rated current of 10 A.

Accessories

Type	Qty.	Order No.
Crimp contacts, male - gold		
HDC-C-HD-SM0.14-0.37AU	100	1651620000
HDC-C-HD-SM0.5AU	100	1651630000
HDC-C-HD-SM0.75-1.00AU	100	1651640000
HDC-C-HD-SM1.5AU	100	1651650000
HDC-C-HD-SM2.5AU	100	1651660000
Crimp contacts, male - silver		
HDC-C-HD-SM0.14-0.37AG	100	1651520000
HDC-C-HD-SM0.5AG	100	1651530000
HDC-C-HD-SM0.75-1.00AG	100	1601750000
HDC-C-HD-SM1.5AG	100	1651550000
HDC-C-HD-SM2.5AG	100	1651560000
HDC C HX SM1.5AG	25	1002910000
HDC C HX SM2.5AG	25	1002920000
HDC C HX SM4.0AG	25	1002930000
HDC C HX SM6.0AG	25	1002940000
Tools		
CTIN CM 1.6/2.5	1	9205430000
CTX CM 1.6/2.5	1	9018490000
REMOVAL TOOL HD	1	1866730000
REMOVAL TOOL HX	1	1002990000

Female

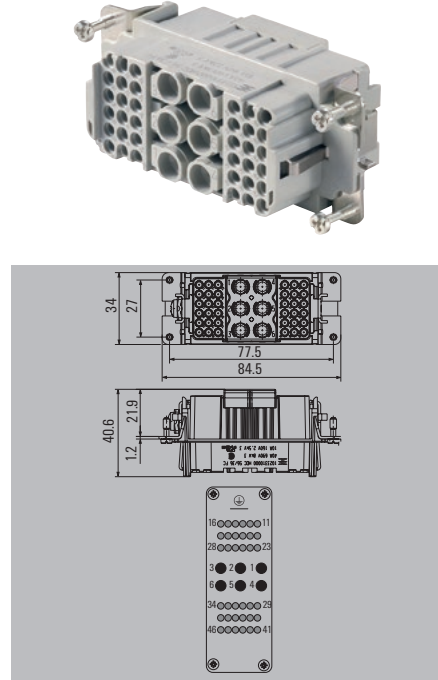

Ordering data

Type of connection	Type	Qty.	Order No.
Crimp connection	HDC S6/36 FC	1	1023310000

The signal contacts are designed for a rated voltage of 160 V and a rated current of 10 A.

Accessories

Type	Qty.	Order No.
Crimp contacts, female - gold		
HDC-C-HD-BM0.14-0.37AU	100	1651670000
HDC-C-HD-BM0.5AU	100	1651680000
HDC-C-HD-BM0.75-1.00AU	100	1651690000
HDC-C-HD-BM1.5AU	100	1651700000
HDC-C-HD-BM2.5AU	100	1651710000
Crimp contacts, female - silver		
HDC-C-HD-BM0.14-0.37AG	100	1651570000
HDC-C-HD-BM0.5AG	100	1651580000
HDC-C-HD-BM0.75-1.00AG	100	1601760000
HDC-C-HD-BM1.5AG	100	1651600000
HDC-C-HD-BM2.5AG	100	1651610000
HDC C HX BM1.5AG	25	1002950000
HDC C HX BM2.5AG	25	1002960000
HDC C HX BM4.0AG	25	1002970000
HDC C HX BM6.0AG	25	1002980000
Tools		
CTIN CM 1.6/2.5	1	9205430000
CTX CM 1.6/2.5	1	9018490000
REMOVAL TOOL HD	1	1866730000
REMOVAL TOOL HX	1	1002990000

Housing selection RockStar® IP65
Size 6

 For additional housings, refer to
Chapter D for IP65 / Chapter E for IP65 EMC /
Chapter F for IP68 EMC

Hood

Plug housing, cable entry sideways



a	Version	Cover	b (mm)	Type	Order No.
M 25	w. thread		61	HDC 16B TSBU 1M25G	1788180000
M 25	w. thread		76	HDC 40D TSBU 1M25G	1787010000
M 32	w. thread		76	HDC 40D TSBU 1M32G	1787000000

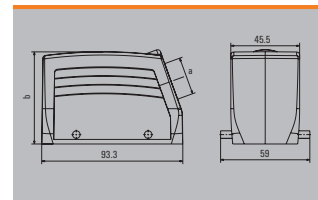

Plug housing, cable entry at top



a	Version	Cover	b (mm)	Type	Order No.
M 25	w. thread		61	HDC 16B TOBU 1M25G	1788210000
M 25	w. thread		76	HDC 40D TOBU 1M25G	1787070000
M 32	w. thread		76	HDC 40D TOBU 1M32G	1787060000

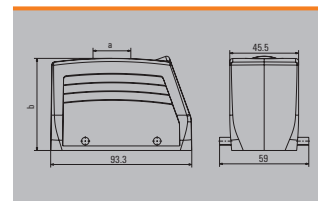

Cover



Version	Type	Order No.
For hoods	HDC 16B DMDQ 2QB	1665270000

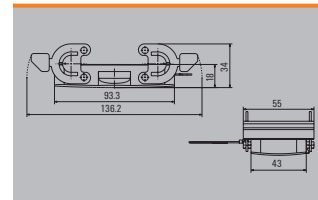

Base

Bulkhead housing



Version	Cover	b (mm)	Type	Order No.
		29	HDC 16B ABU	1208600000
		29	HDC 16B ABU N	2488590000

Note: N = Plastic locking lever with stainless steel inlay

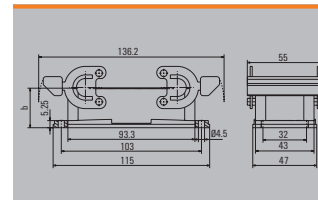

Base housing



a	Version	Cover	b (mm)	Type	Order No.
M 25	Side-locking		64	HDC 16B SBU 1M25G N	2560740000
M 25	Side-locking		64	HDC 16B SBU 2M25G	1788240000
M 25	Side-locking		64	HDC 16B SBU 2M25G N	2560930000
M 25	Side-locking		84	HDC 40D SBU 2M25G	1787120000
PG 21	Side-locking		84	HDC 40D SBU 1M32G N	2561030000
M 32	Side-locking		84	HDC 40D SBU 2M32G	1787110000

Note: N = Plastic locking lever with stainless steel inlay

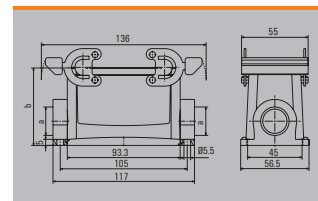

Coupling housing



a	Version	Cover	b (mm)	Type	Order No.
M 25	w. thread		78.6	HDC 40D KBU 1M25G	1787200000
PG 29	w. thread		79	HDC 40D KBU 1M25G N	2559890000
M 32	w. thread		78.6	HDC 40D KBU 1M32G	1787190000
PG 29	w. thread		79	HDC 40D KBU 1M32G N	2559900000
PG 29	w. thread		79	HDC 40D KBU 2M32G N	2545510000

Note: N = Plastic locking lever with stainless steel inlay

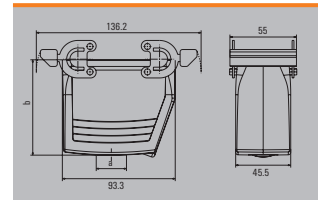

Cover



Version	Type	Order No.
For bases	HDC 16B DDDQ 480	1665260000

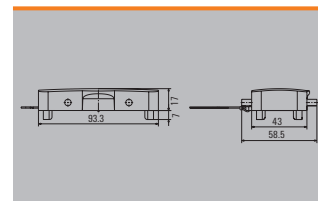

690 V, 48 A, size 6

6 + 12 + ⊕

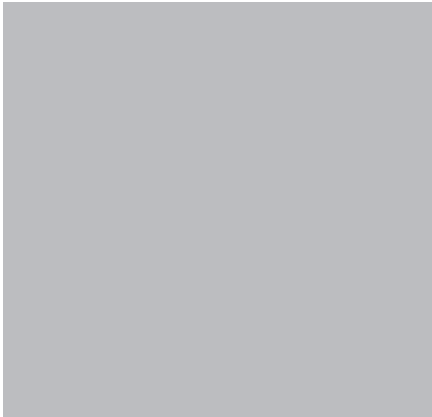
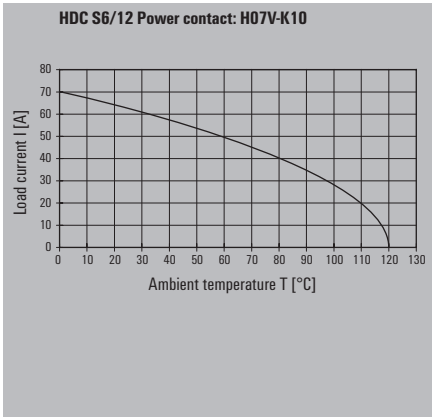

Male

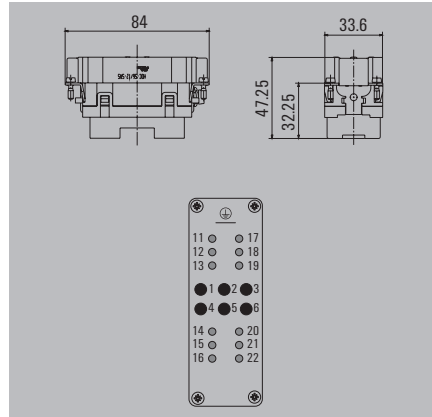
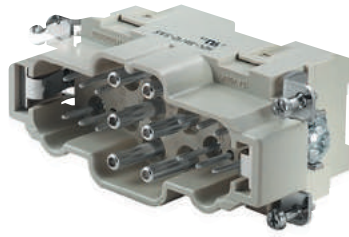

Ordering data

Type of connection	Type	Qty.	Order No.
Axial screw connection	HDC S6 12 SAS	1	1790000000

The signal contacts are designed for a rated voltage of 400V and a rated current of 16A.

Female

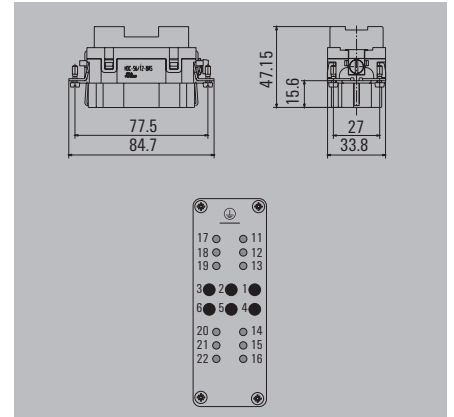

Ordering data

Type of connection	Type	Qty.	Order No.
Axial screw connection	HDC S6 12 BAS	1	1790010000

The signal contacts are designed for a rated voltage of 400V and a rated current of 16A.

Installation cut-out

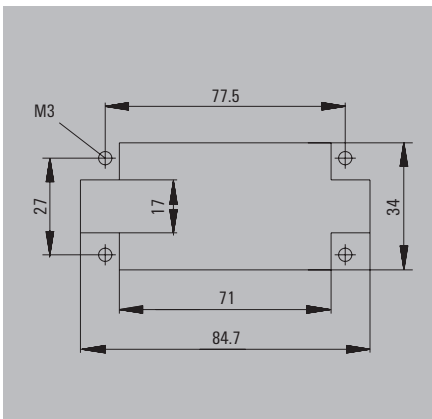

Housing selection RockStar® IP65
Size 6

 For additional housings, refer to
Chapter D for IP65 / Chapter E for IP65 EMC /
Chapter F for IP68 EMC

Hood

Plug housing, cable entry sideways



a	Version	Cover	b (mm)	Type	Order No.
M 25	w. thread		61	HDC 16B TSBU 1M25G	1788180000
M 25	w. thread		76	HDC 40D TSBU 1M25G	1787010000
M 32	w. thread		76	HDC 40D TSBU 1M32G	1787000000

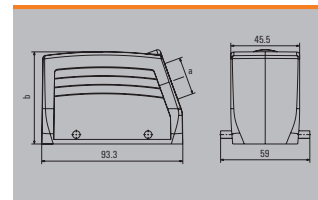

Plug housing, cable entry at top



a	Version	Cover	b (mm)	Type	Order No.
M 25	w. thread		61	HDC 16B TOBU 1M25G	1788210000
M 25	w. thread		76	HDC 40D TOBU 1M25G	1787070000
M 32	w. thread		76	HDC 40D TOBU 1M32G	1787060000

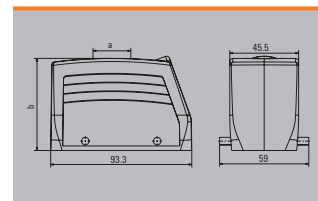

Cover



Version	Type	Order No.
For hoods	HDC 16B DMDQ 2QB	1665270000

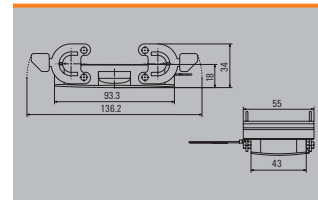

Base

Bulkhead housing



Version	Cover	b (mm)	Type	Order No.
		29	HDC 16B ABU	1208600000
		29	HDC 16B ABU N	2488590000

Note: N = Plastic locking lever with stainless steel inlay

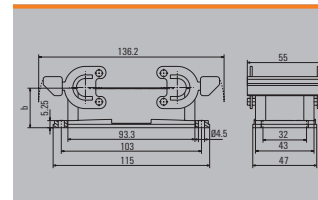

Base housing



a	Version	Cover	b (mm)	Type	Order No.
M 25	Side-locking		64	HDC 16B SBU 1M25G N	2560740000
M 25	Side-locking		64	HDC 16B SBU 2M25G	1788240000
M 25	Side-locking		64	HDC 16B SBU 2M25G N	2560930000
M 25	Side-locking		84	HDC 40D SBU 2M25G	1787120000
PG 21	Side-locking		84	HDC 40D SBU 1M32G N	2561030000
M 32	Side-locking		84	HDC 40D SBU 2M32G	1787110000

Note: N = Plastic locking lever with stainless steel inlay

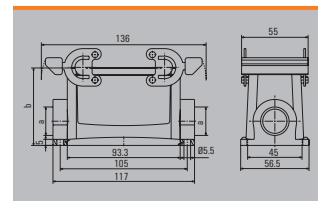

Coupling housing



a	Version	Cover	b (mm)	Type	Order No.
M 25	w. thread		78.6	HDC 40D KBU 1M25G	1787200000
PG 29	w. thread		79	HDC 40D KBU 1M25G N	2559890000
M 32	w. thread		78.6	HDC 40D KBU 1M32G	1787190000
PG 29	w. thread		79	HDC 40D KBU 1M32G N	2559900000
PG 29	w. thread		79	HDC 40D KBU 2M32G N	2545510000

Note: N = Plastic locking lever with stainless steel inlay

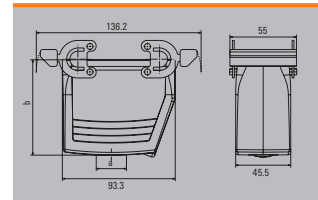

Cover



Version	Type	Order No.
For bases	HDC 16B DDDQ 480	1665260000

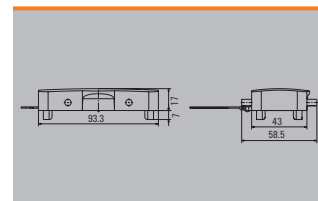

690 V, 40 A, size 6

12 + 2 + ⊕

HDC S12/2 / Power contact: H07V-K6 /
Signal contact: H07V-K2.5 / 12/2 poles

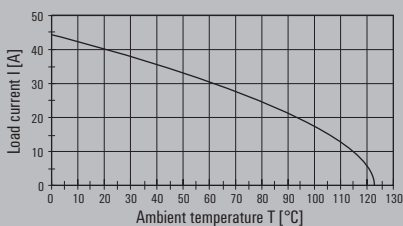

Male

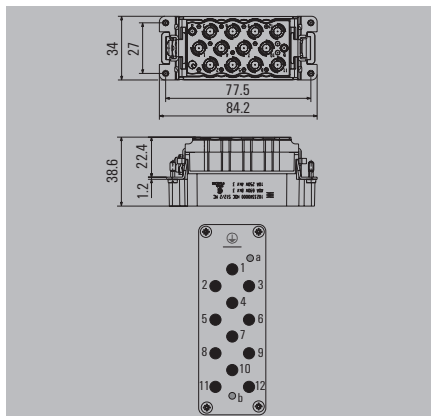
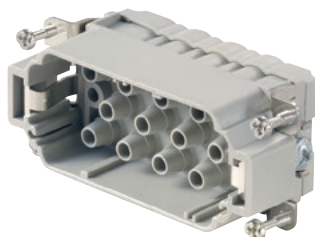

Ordering data

Type of connection	Type	Qty.	Order No.
Crimp connection	HDC S12/2 MC	1	1023340000

The signal contacts are designed for a rated voltage of 250 V and a rated current of 10 A.

Accessories

Type	Qty.	Order No.
Crimp contacts, male - gold		
HDC-C-HD-SM0.14-0.37AU	100	1651620000
HDC-C-HD-SM0.5AU	100	1651630000
HDC-C-HD-SM0.75-1.00AU	100	1651640000
HDC-C-HD-SM1.5AU	100	1651650000
HDC-C-HD-SM2.5AU	100	1651660000
Crimp contacts, male - silver		
HDC-C-HD-SM0.14-0.37AG	100	1651520000
HDC-C-HD-SM0.5AG	100	1651530000
HDC-C-HD-SM0.75-1.00AG	100	1601750000
HDC-C-HD-SM1.5AG	100	1651550000
HDC-C-HD-SM2.5AG	100	1651560000
HDC C HX SM1.5AG	25	1002910000
HDC C HX SM2.5AG	25	1002920000
HDC C HX SM4.0AG	25	1002930000
HDC C HX SM6.0AG	25	1002940000
Tools		
CTIN CM 1.6/2.5	1	9205430000
CTX CM 1.6/2.5	1	9018490000
REMOVAL TOOL HD	1	1866730000
REMOVAL TOOL HX	1	1002990000

Female

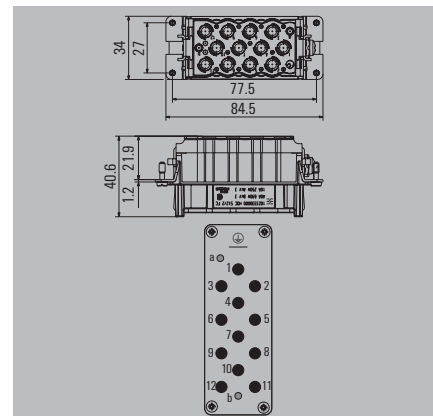

Ordering data

Type of connection	Type	Qty.	Order No.
Crimp connection	HDC S12/2 FC	1	1023330000

The signal contacts are designed for a rated voltage of 250 V and a rated current of 10 A.

Accessories

Type	Qty.	Order No.
Crimp contacts, female - gold		
HDC-C-HD-BM0.14-0.37AU	100	1651670000
HDC-C-HD-BM0.5AU	100	1651680000
HDC-C-HD-BM0.75-1.00AU	100	1651690000
HDC-C-HD-BM1.5AU	100	1651700000
HDC-C-HD-BM2.5AU	100	1651710000
Crimp contacts, female - silver		
HDC-C-HD-BM0.14-0.37AG	100	1651570000
HDC-C-HD-BM0.5AG	100	1651580000
HDC-C-HD-BM0.75-1.00AG	100	1601760000
HDC-C-HD-BM1.5AG	100	1651600000
HDC-C-HD-BM2.5AG	100	1651610000
HDC C HX BM1.5AG	25	1002950000
HDC C HX BM2.5AG	25	1002960000
HDC C HX BM4.0AG	25	1002970000
HDC C HX BM6.0AG	25	1002980000
Tools		
CTIN CM 1.6/2.5	1	9205430000
CTX CM 1.6/2.5	1	9018490000
REMOVAL TOOL HD	1	1866730000
REMOVAL TOOL HX	1	1002990000

Installation cut-out

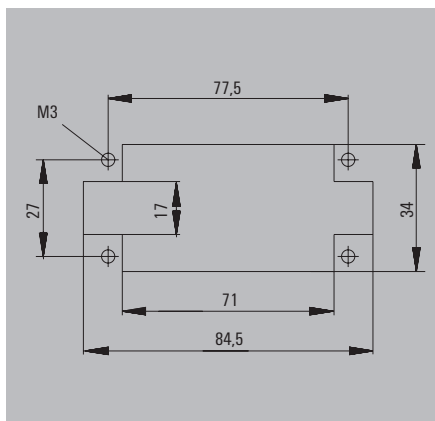

Housing selection RockStar® IP65
Size 6

➔ For additional housings, refer to
Chapter D for IP65 / Chapter E for IP65 EMC /
Chapter F for IP68 EMC

Hood

Plug housing, cable entry sideways



a	Version	Cover	b (mm)	Type	Order No.
M 25	w. thread		61	HDC 16B TSBU 1M25G	1788180000
M 25	w. thread		76	HDC 40D TSBU 1M25G	1787010000
M 32	w. thread		76	HDC 40D TSBU 1M32G	1787000000

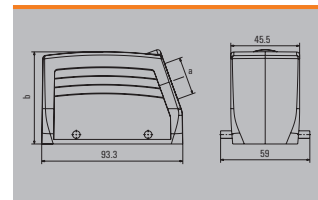

Plug housing, cable entry at top



a	Version	Cover	b (mm)	Type	Order No.
M 25	w. thread		61	HDC 16B TOBU 1M25G	1788210000
M 25	w. thread		76	HDC 40D TOBU 1M25G	1787070000
M 32	w. thread		76	HDC 40D TOBU 1M32G	1787060000

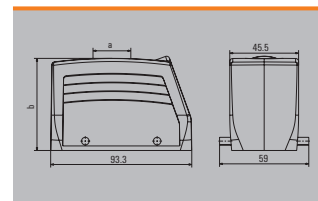

Cover



Version	Type	Order No.
For hoods	HDC 16B DMDQ 2QB	1665270000

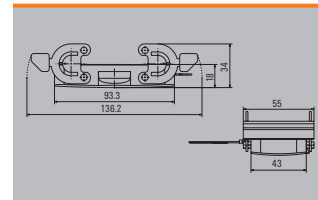

Base

Bulkhead housing



Version	Cover	b (mm)	Type	Order No.
		29	HDC 16B ABU	1208600000
		29	HDC 16B ABU N	2488590000

Note: N = Plastic locking lever with stainless steel inlay

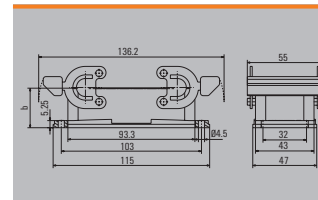

Base housing



a	Version	Cover	b (mm)	Type	Order No.
M 25	Side-locking		64	HDC 16B SBU 1M25G N	2560740000
M 25	Side-locking		64	HDC 16B SBU 2M25G	1788240000
M 25	Side-locking		64	HDC 16B SBU 2M25G N	2560930000
M 25	Side-locking		84	HDC 40D SBU 2M25G	1787120000
PG 21	Side-locking		84	HDC 40D SBU 1M32G N	2561030000
M 32	Side-locking		84	HDC 40D SBU 2M32G	1787110000

Note: N = Plastic locking lever with stainless steel inlay

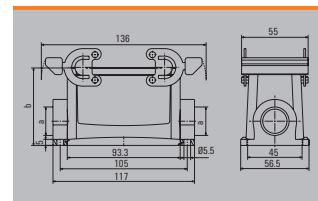

Coupling housing



a	Version	Cover	b (mm)	Type	Order No.
M 25	w. thread		78.6	HDC 40D KBU 1M25G	1787200000
PG 29	w. thread		79	HDC 40D KBU 1M25G N	2559890000
M 32	w. thread		78.6	HDC 40D KBU 1M32G	1787190000
PG 29	w. thread		79	HDC 40D KBU 1M32G N	2559900000
PG 29	w. thread		79	HDC 40D KBU 2M32G N	2545510000

Note: N = Plastic locking lever with stainless steel inlay

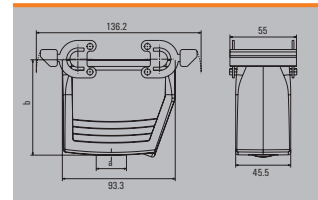

Cover



Version	Type	Order No.
For bases	HDC 16B DDDQ 480	1665260000

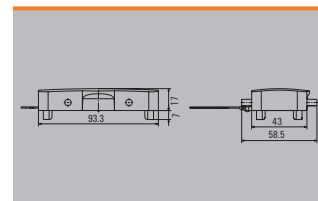

400 V, 80 A, size 8

4 + 8 + ⊕

HDC S4 / 8 / Power contact: H07V-K16 /
Signal contact: H07V-K2.5 / 4/8 poles

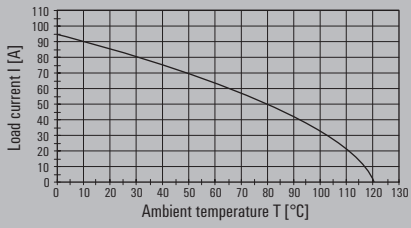

Male

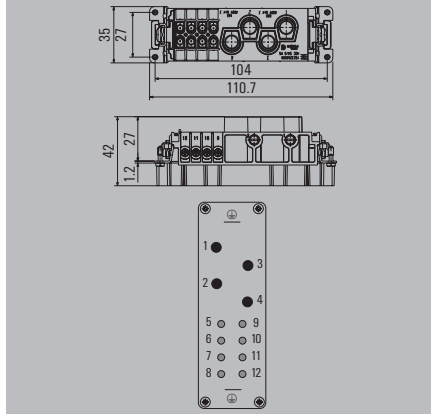
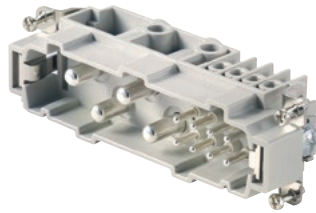

Female

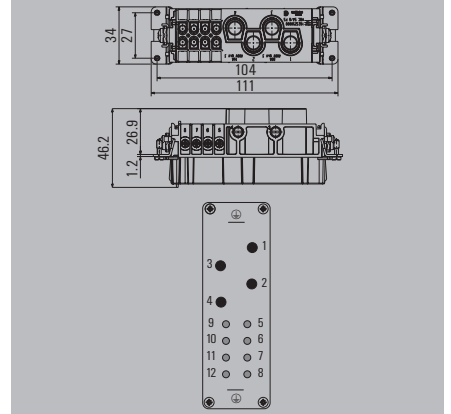
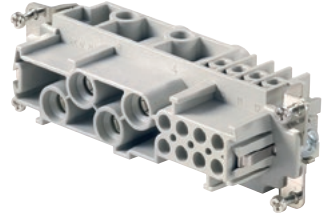

Ordering data

Type of connection	Type	Qty.	Order No.
Screw connection	HDC S4/8 MS	1	1023260000

The signal contacts are designed for a rated voltage of 400V and a rated current of 16A.

Ordering data

Type of connection	Type	Qty.	Order No.
Screw connection	HDC S4/8 FS	1	1023250000

The signal contacts are designed for a rated voltage of 400V and a rated current of 16A.

Installation cut-out

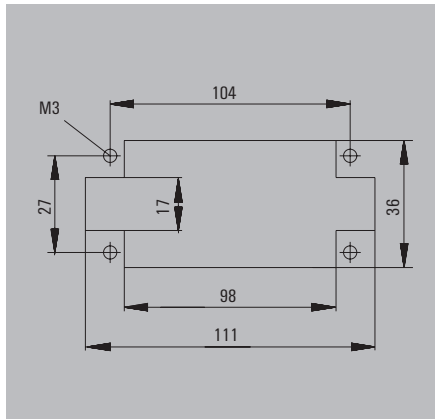

Housing selection RockStar® IP65
Size 8



For additional housings, refer to
Chapter D for IP65 / Chapter E for IP65 EMC /
Chapter F for IP68 EMC

Hood

Plug housing, cable entry sideways



a	Version	Cover	b (mm)	Type	Order No.
M 25	w. thread		62.58	HDC 24B TSBU 1M25G	1787760000
M 25	w. thread		76	HDC 64D TSBU 1M25G	1786780000
M 32	w. thread		62.58	HDC 24B TSBU 1M32G	1787750000
M 32	w. thread		76	HDC 64D TSBU 1M32G	1786770000

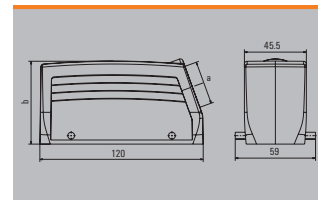

Plug housing, cable entry at top



a	Version	Cover	b (mm)	Type	Order No.
M 25	w. thread		62.58	HDC 24B TOBU 1M25G	1787820000
M 32	w. thread		62.58	HDC 24B TOBU 1M32G	1787810000
M 32	w. thread		76	HDC 64D TOBU 1M32G	1786830000

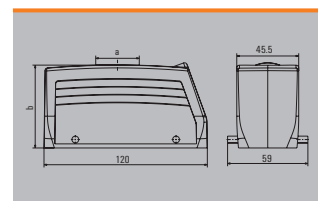

Cover



Version	Type	Order No.
For hoods	HDC 24B DMDQ 2QB	1665640000
For hoods	HDC 24B DMDQ 2QB N	2559760000

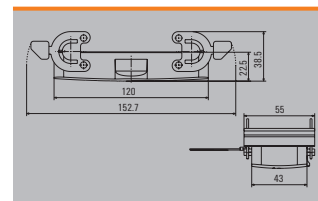

Note: N = Plastic locking lever with stainless steel inlay

Base

Bulkhead housing



Version	Cover	b (mm)	Type	Order No.
		29.5	HDC 24B ABU	1212400000
		29.5	HDC 24B ABU N	2488600000

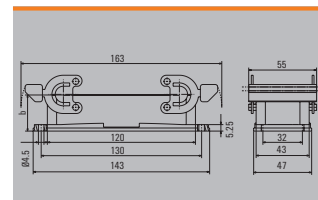

Note: N = Plastic locking lever with stainless steel inlay

Base housing



a	Version	Cover	b (mm)	Type	Order No.
M 25	Side-locking		64	HDC 24B SBU 2M25G	1787870000
M 25	Side-locking		64	HDC 24B SBU 2M25G N	2560970000
M 25	Side-locking		84	HDC 64D SBU 2M25G	1786890000
M 32	Side-locking		84	HDC 64D SBU 2M25G N	2561060000
M 32	Side-locking		84	HDC 64D SBU 1M32G N	2561050000
M 32	Side-locking		84	HDC 64D SBU 2M32G	1786880000

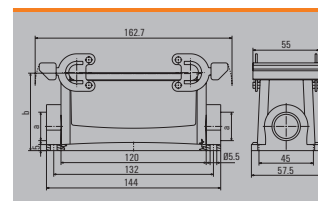

Note: N = Plastic locking lever with stainless steel inlay

Coupling housing



a	Version	Cover	b (mm)	Type	Order No.
M 25	w. thread		65	HDC 24B KBU 1M25G	1787920000
M 25	w. thread		65	HDC 24B KBU 1M25G N	2559870000
M 32	w. thread		65	HDC 24B KBU 2M32G N	2559880000
M 32	w. thread		79	HDC 64D KBU 1M32G	1786960000
M 32	w. thread		79	HDC 64D KBU 1M32G N	2559910000

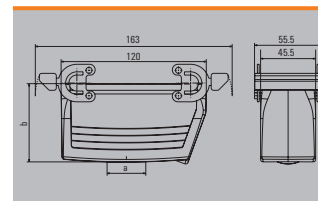

Note: N = Plastic locking lever with stainless steel inlay

Cover



Version	Type	Order No.
For bases	HDC 24B DDDQ 4B0	1665630000

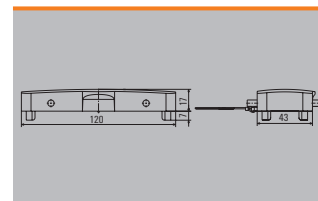

690 V, 100 A, size 8

6 + 6 + ⊕

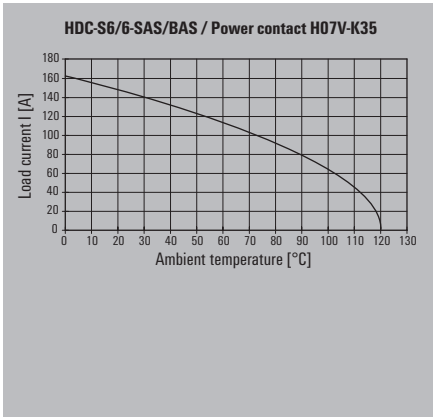

Male

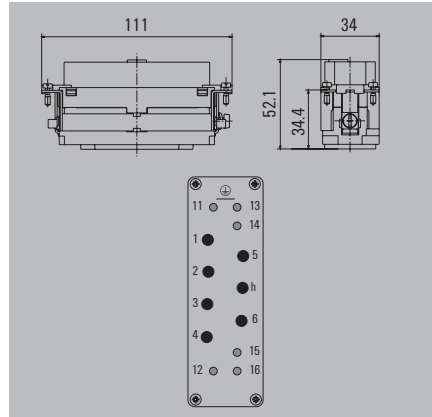

Ordering data

Type of connection	Type	Qty.	Order No.
Axial screw connection	HDC S6 6 SAS	1	1790030000

The signal contacts are designed for a rated voltage of 400V and a rated current of 16A.

Female

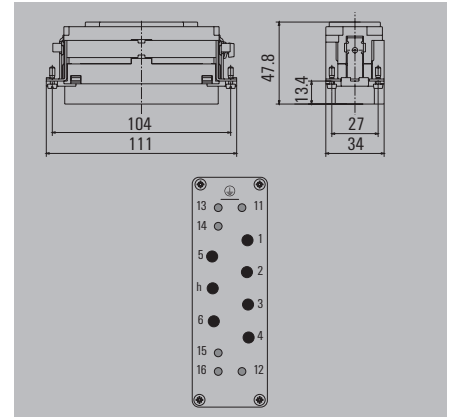

Ordering data

Type of connection	Type	Qty.	Order No.
Axial screw connection	HDC S6 6 BAS	1	1790020000

The signal contacts are designed for a rated voltage of 400V and a rated current of 16A.

Installation cut-out

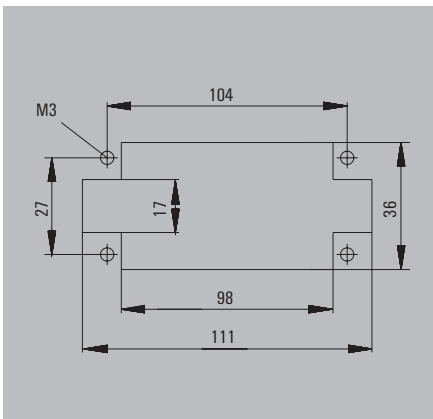

Housing selection RockStar® IP65
Size 8



For additional housings, refer to
Chapter D for IP65 / Chapter E for IP65 EMC /
Chapter F for IP68 EMC

Hood

Plug housing, cable entry sideways



a	Version	Cover	b (mm)	Type	Order No.
M 25	w. thread		62.58	HDC 24B TSBU 1M25G	1787760000
M 25	w. thread		76	HDC 64D TSBU 1M25G	1786780000
M 32	w. thread		62.58	HDC 24B TSBU 1M32G	1787750000
M 32	w. thread		76	HDC 64D TSBU 1M32G	1786770000

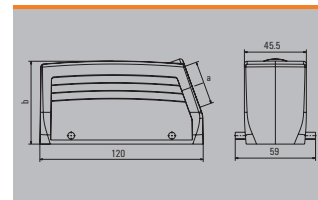

Plug housing, cable entry at top



a	Version	Cover	b (mm)	Type	Order No.
M 25	w. thread		62.58	HDC 24B TOBU 1M25G	1787820000
M 32	w. thread		62.58	HDC 24B TOBU 1M32G	1787810000
M 32	w. thread		76	HDC 64D TOBU 1M32G	1786830000

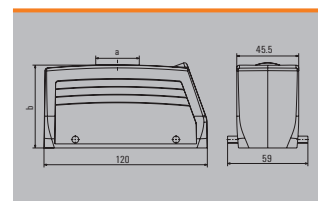

Cover



Version	Type	Order No.
For hoods	HDC 24B DMDQ 2QB	1665640000
For hoods	HDC 24B DMDQ 2QB N	2559760000

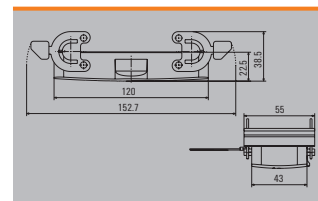

Note: N = Plastic locking lever with stainless steel inlay

Base

Bulkhead housing



Version	Cover	b (mm)	Type	Order No.
		29.5	HDC 24B ABU	1212400000
		29.5	HDC 24B ABU N	2488600000

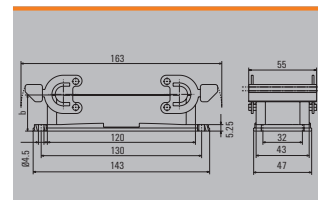

Note: N = Plastic locking lever with stainless steel inlay

Base housing



a	Version	Cover	b (mm)	Type	Order No.
M 25	Side-locking		64	HDC 24B SBU 2M25G	1787870000
M 25	Side-locking		64	HDC 24B SBU 2M25G N	2560970000
M 25	Side-locking		84	HDC 64D SBU 2M25G	1786890000
M 32	Side-locking		84	HDC 64D SBU 2M25G N	2561060000
M 32	Side-locking		84	HDC 64D SBU 1M32G N	2561050000
M 32	Side-locking		84	HDC 64D SBU 2M32G	1786880000

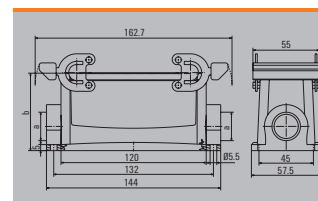

Note: N = Plastic locking lever with stainless steel inlay

Coupling housing



a	Version	Cover	b (mm)	Type	Order No.
M 25	w. thread		65	HDC 24B KBU 1M25G	1787920000
M 25	w. thread		65	HDC 24B KBU 1M25G N	2559870000
M 32	w. thread		65	HDC 24B KBU 2M32G N	2559880000
M 32	w. thread		79	HDC 64D KBU 1M32G	1786960000
M 32	w. thread		79	HDC 64D KBU 1M32G N	2559910000

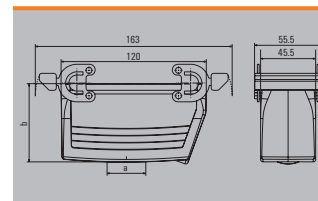

Note: N = Plastic locking lever with stainless steel inlay

Cover



Version	Type	Order No.
For bases	HDC 24B DDDQ 4B0	1665630000

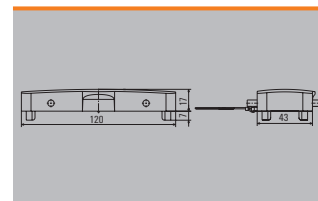

690 V, 110 A, size 8

8 + 0 + ⊕

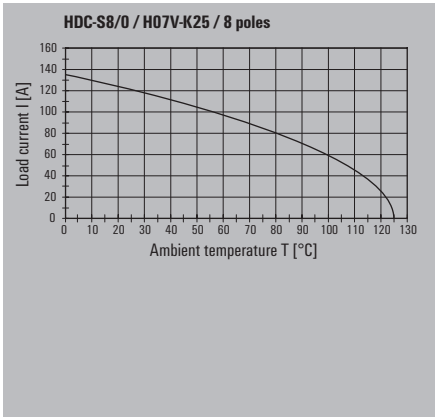

Male

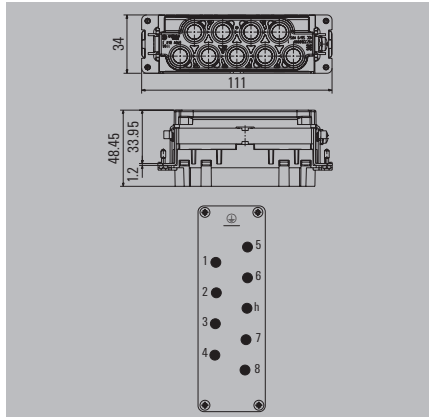

Ordering data

Type of connection	Type	Qty.	Order No.
Axial screw connection	HDC S8/0 MAS	1	1023360000

Female

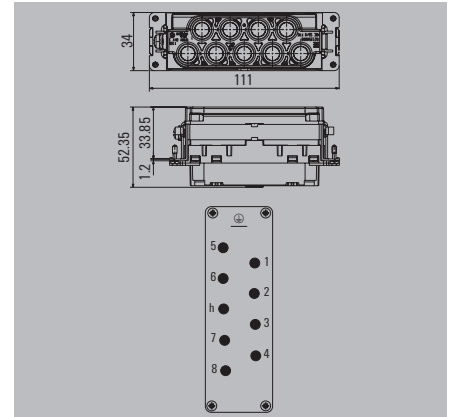
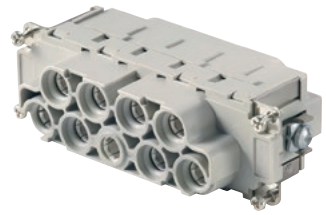

Ordering data

Type of connection	Type	Qty.	Order No.
Axial screw connection	HDC S8/0 FAS	1	1023350000

Installation cut-out

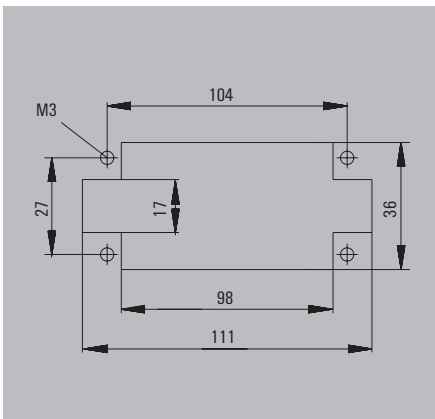

Housing selection RockStar® IP65
Size 8



For additional housings, refer to
Chapter D for IP65 / Chapter E for IP65 EMC /
Chapter F for IP68 EMC

Hood

Plug housing, cable entry sideways



a	Version	Cover	b (mm)	Type	Order No.
M 25	w. thread		62.58	HDC 24B TSBU 1M25G	1787760000
M 25	w. thread		76	HDC 64D TSBU 1M25G	1786780000
M 32	w. thread		62.58	HDC 24B TSBU 1M32G	1787750000
M 32	w. thread		76	HDC 64D TSBU 1M32G	1786770000

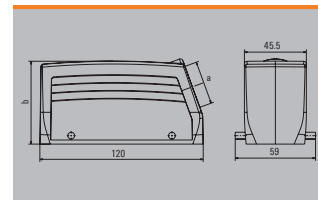

Plug housing, cable entry at top



a	Version	Cover	b (mm)	Type	Order No.
M 25	w. thread		62.58	HDC 24B TOBU 1M25G	1787820000
M 32	w. thread		62.58	HDC 24B TOBU 1M32G	1787810000
M 32	w. thread		76	HDC 64D TOBU 1M32G	1786830000

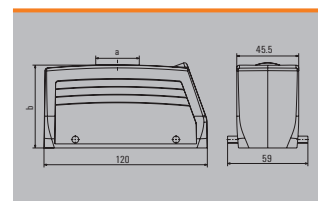

Cover



Version	Type	Order No.
For hoods	HDC 24B DMDQ 2QB	1665640000
For hoods	HDC 24B DMDQ 2QB N	2559760000

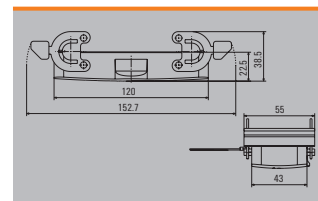

Note: N = Plastic locking lever with stainless steel inlay

Base

Bulkhead housing



Version	Cover	b (mm)	Type	Order No.
		29.5	HDC 24B ABU	1212400000
		29.5	HDC 24B ABU N	2488600000

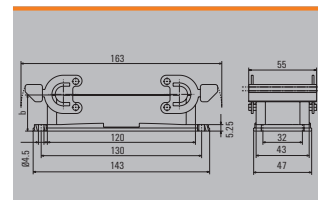

Note: N = Plastic locking lever with stainless steel inlay

Base housing



a	Version	Cover	b (mm)	Type	Order No.
M 25	Side-locking		64	HDC 24B SBU 2M25G	1787870000
M 25	Side-locking		64	HDC 24B SBU 2M25G N	2560970000
M 25	Side-locking		84	HDC 64D SBU 2M25G	1786890000
M 32	Side-locking		84	HDC 64D SBU 2M25G N	2561060000
M 32	Side-locking		84	HDC 64D SBU 1M32G N	2561050000
M 32	Side-locking		84	HDC 64D SBU 2M32G	1786880000

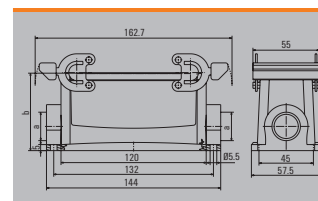

Note: N = Plastic locking lever with stainless steel inlay

Coupling housing



a	Version	Cover	b (mm)	Type	Order No.
M 25	w. thread		65	HDC 24B KBU 1M25G	1787920000
M 25	w. thread		65	HDC 24B KBU 1M25G N	2559870000
M 32	w. thread		65	HDC 24B KBU 2M32G N	2559880000
M 32	w. thread		79	HDC 64D KBU 1M32G	1786960000
M 32	w. thread		79	HDC 64D KBU 1M32G N	2559910000

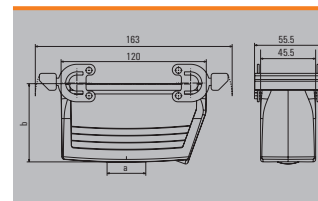

Note: N = Plastic locking lever with stainless steel inlay

Cover



Version	Type	Order No.
For bases	HDC 24B DDDQ 4B0	1665630000

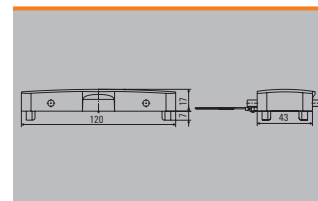

RockStar® ModuPlug modular system

RockStar® ModuPlug modular system	Introduction	C.2
	RockStar® ModuPlug frames	C.8
	RockStar® ModuPlug modules	C.12
	RockStar® ModuPlug Field attachable data connector	C.48
	RockStar® ModuPlug data inserts	C.54
	RockStar® ModuPlug RJ45 modules	C.63
	RockStar® ModuPlug pneumatic modules	C.65

RockStar® ModuPlug

Great performance in the smallest of spaces

Industrial applications are becoming increasingly complex. The demands being made of the connectivity used are growing at the same time. Functionality in the smallest of installation spaces, safe installation and a fast retrofitting process are just some of the product properties being called for.

Not only does our RockStar® ModuPlug modular plug-in connector system meet current market requirements; it has been specially designed with the future in mind too. Thanks to the new variety of module sizes, you can fit more applications than ever before in one plug-in connector. The modules reduce the amount of space required and cut costs when compared with fixed-pole inserts and other modular plug-in connector systems.

The sophisticated frames and modules can be installed with extreme ease and integrated into HDC enclosures with the IP65 and IP68 protection classes. You can even use the RockStar® ModuPlug to supplement existing applications without any need to make system adjustments.

Pneumatic modules

The new pneumatic modules can be integrated into any connector configuration. They enable the safe and efficient supply of compressed air to drives, controls, braking systems, holding, and unloading devices.



Terminal block modules

The new terminal block modules with PUSH IN connection technology open up unexpected possibilities – especially for distribution solutions in the otherwise unused area on the control cabinet wall. With up to 48 poles in one connector, they enable particularly efficient wiring from the field to the devices in the control cabinet.

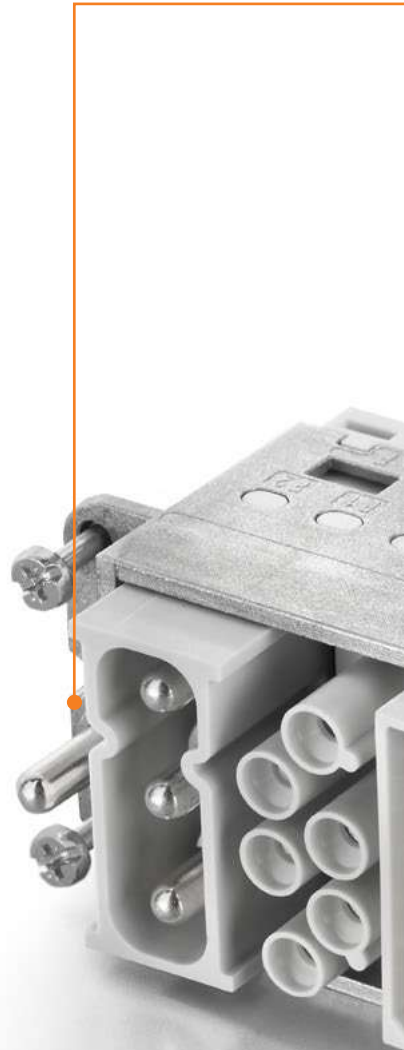

Simple

The innovative sliding frame has two defined locking positions for opening and closing – thus enabling simple, tool-free module installation.



Secure

The round and rectangular coding on the frame enables intuitive module plug-in. The two-point fixation prevents incorrect connection and keeps the modules tilt and vibration-resistant.

C

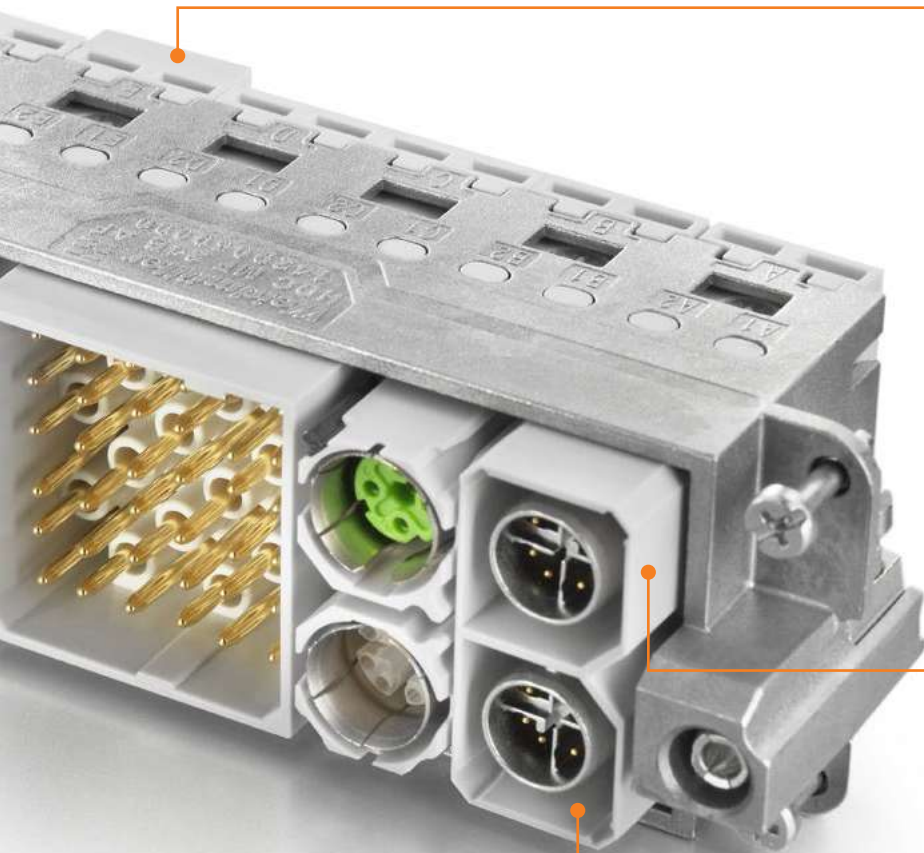

Flexible

The four module sizes make for individual plug solutions that save a huge amount of space. The smaller pitch translates into an optimised design too.

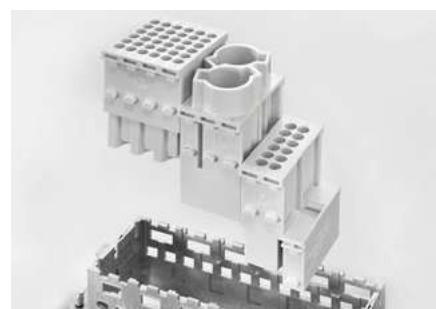





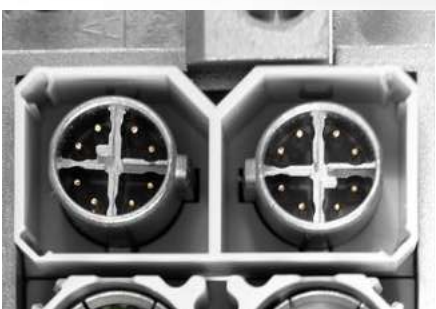

















Compact

The new two-pole bus module is particularly compact and can accommodate megabit and gigabit data inserts. It enables the transmission of two Gigabit Cat 6A (10Gbit) cables in one module.







RockStar® ModuPlug modular system

Data inserts





		Size	Rated voltage	Rated current	No. of poles	Connection	Wire cross-section	Type	Order No. Male	Order No. Female	Page
		1.5	1,000 V	200 A	1	Crimp	25 – 70 mm ²	HDC MHP 200	2548900000	2549260000	C.12
		2	1,000 V	200 A	1	Axial screw	25 – 70 mm ²	HDC MHP 200	2748240000	2748250000	C.13
		2	1,000 V	200 A	1	Axial screw	25 – 70 mm ²	HDC MHP 200 PE	2748260000	2748270000	C.14
		1.5	1,000 V	100 A	2	Crimp	10 – 35 mm ²	HDC MHP 100	1429060000	1429080000	C.15
		2	1,000 V	100 A	2	Axial screw	10 – 35 mm ²	HDC MHP 100	2748280000	2748290000	C.16
		2	2,900 V	16 A	2	Crimp	0.5 – 4 mm ²	HDC MHE 2 HV	2748380000	2748390000	C.17
		1	1,000 V	70 A	2	Crimp	6 – 25 mm ²	HDC MHP 70	2668190000	2668180000	C.18
		1	1,000 V	70 A	2	Axial screw	4 – 25 mm ²	HDC MHP 70	2748300000	2748310000	C.19
		1	830 V	40 A	2	Crimp	1.5 – 10 mm ²	HDC MHX 2	2748340000	2748350000	C.20
		1	830 V	40 A	2	Axial screw	2.5 – 10 mm ²	HDC MHX 2	2748320000	2748330000	C.21
		1	830 V	40 A	4	Crimp	1.5 – 6 mm ²	HDC MHX 4P	1428950000	1428970000	C.22
		1	830 V	40 A	4	PUSH IN	2.5 – 6 mm ²	HDC MHX 4P	2772800000	2772810000	C.23
		1	690 V	40 A	3	Crimp	1.5 – 10 mm ²	HDC MHX 3	1429340000	1429350000	C.24
		1	690 V	40 A	3	PUSH IN	2.5 – 6 mm ²	HDC MHX 3	2772780000	2772790000	C.25
		1	500 V	40 A / 10 A	3/4	Crimp	1.5 – 6 mm ² / 0.14 – 2.5 mm ²	HDC MHX 3/4	2748360000	2748370000	C.26
		1	830 V	16 A	6	Crimp	0.5 – 4 mm ²	HDC MHE 6P	1505650000	1505660000	C.27
		2	500 V	16 A	20	Crimp	0.5 – 4 mm ²	HDC MHE 20	1428910000	1428930000	C.28
		1	400 V	16 A	8	Crimp	0.5 – 4 mm ²	HDC MHE 8	1428880000	1428890000	C.29
		1	400 V	16 A	6	PUSH IN	0.5 – 2.5 mm ²	HDC MHE 8	2748440000	2748450000	C.30

Data inserts

		Size	Rated voltage	Rated current	No. of poles	Connection	Wire cross-section	Type	Order No. Male	Order No. Female	Page
		1	500 V	16 A	6	Crimp	0.5 - 4 mm ²	HDC MHE 6	1429360000	1429370000	C.31
		1	500 V	16 A	6	PUSH IN	0.5 - 2.5 mm ²	HDC MHE 6	2748420000	2748430000	C.32
		1	400 V	16 A	5	PUSH IN	0.5 - 2.5 mm ²	HDC MHE 5	2636180000	2636190000	C.33
		1	230 V	16 A	5	PUSH IN	0.25 - 1.5 mm ²	HDC MHE 5L	2748400000	2748410000	C.34
		0.5	250 V	16 A	4	PUSH IN	0.5 - 2.5 mm ²	HDC MHE 4	2635980000	2635990000	C.35
		0.5	250 V	16 A	4	PUSH IN	0.5 - 2.5 mm ²	HDC MHE 4X	2636070000	2636060000	C.36
		0.5	250 V	16 A	4	PUSH IN	0.5 - 2.5 mm ²	HDC MHE 4X2	2635980000	2635990000	C.37
		2	250 V	10 A	36	Crimp	0.14 - 2.5 mm ²	HDC MHD 36	1428860000	1428870000	C.38
		1	160 V	10 A	17	Crimp	0.14 - 2.5 mm ²	HDC MHD 17	2748480000	2748490000	C.39
		1	250 V	10 A	12	Crimp	0.14 - 2.5 mm ²	HDC MHD 12	1428840000	1428850000	C.40
		1	250 V	10 A	12	PUSH IN	0.14 - 1.5 mm ²	HDC MHD 12	2748460000	2748470000	C.41
		1	50 V	5 A	8	Crimp	0.08 - 0.5 mm ²	HDC MGBIT 8	2748520000	2748530000	C.42
		2	–	–	2	Crimp	0.14 - 2.5 mm ²	HDC MEMC 2	2748560000	2748570000	C.43
		1	50 V	1,5 A	4	Crimp, Lötanschluss	0.14 - 2.5 mm ²	HDC MCOAX 4	2748540000	2748550000	C.45

RockStar® ModuPlug modular system

Data inserts

		Size	Rated voltage	Rated current	No. of poles	Connection	Wire cross-section	Type	Order No. Male	Order No. Female	Page
		1	–	–	2	Data module	–	HDC MBUS 2	1428990000	1429020000	C.46
		0.5	–	–	–	Dummy module	–	HDC MDU	1429040000		C.47
		1	50 V	1 A	1	RJ45 module		HDC MRJ45	2592250000	2592030000	C.63
		1	–	–	2 - 3	Pneumatic module		HDC MPN	2637320000 2637340000		C.65 C.66

RockStar® ModuPlug frames

Size 3

ModuPlug® metal frame

Frame



Version	Type	Order No.
	HDC MF 6B AB	1428920000
	HDC MF 6B BA	1428940000

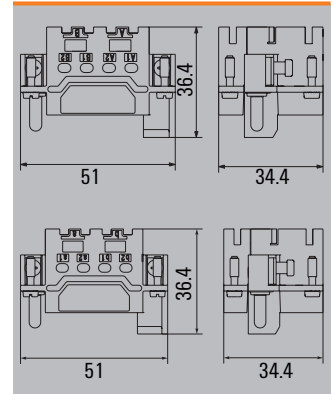

Note 2 module slots; double-sided PE screw connection: 0.5 - 10 mm² (AWG 20 ... 8); prepared conductor in accordance with IEC 60999-1

Frame with short guiding pin



Version	Type	Order No.
	HDC MFGS 6B AB	2736890000
	HDC MFGS 6B BA	2736900000

Note 2 module slots. With this variant, the PE connection on both sides is not required.

Frame with long guiding pin



Version	Type	Order No.
	HDC MFGL 6B AB	2736970000
	HDC MFGL 6B BA	2736980000

Note 2 module slots. With this variant, the PE connection on both sides is not required.

Transport lock



Transport lock for ModuPlug® metal frame		Order No.
HDC MF FIXING		1480290000

Size 4

ModuPlug® metal frame

Frame



Version	Type	Order No.
	HDC MF 10B AC	1428960000
	HDC MF 10B CA	1428980000

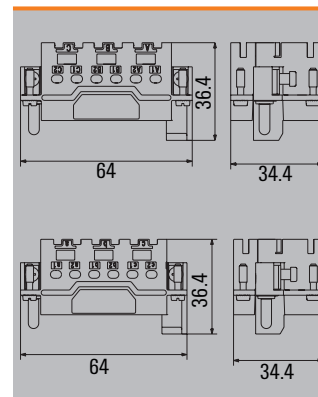

Note 3 module slots; double-sided PE screw connection: 0.5 - 10 mm² (AWG 20 ... 8); prepared conductor in accordance with IEC 60999-1

Frame with short guiding pin



Version	Type	Order No.
	HDC MFGS 10B AC	2736910000
	HDC MFGS 10B CA	2736920000

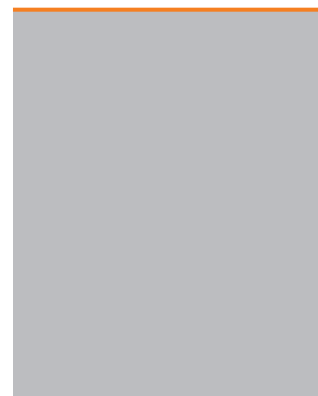

Note 3 module slots. With this variant, the PE connection on both sides is not required.

Frame with long guiding pin



Version	Type	Order No.
	HDC MFGL 10B AC	2736990000
	HDC MFGL 10B CA	2737000000

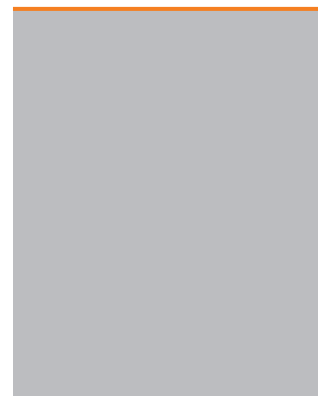

Note 3 module slots. With this variant, the PE connection on both sides is not required.

Transport lock



Transport lock for ModuPlug® metal frame		Order No.
HDC MF FIXING		1480290000



RockStar® ModuPlug frames

Size 6

ModuPlug® metal frame

Frame



Version	Type	Order No.
	HDC MF 16B AD	1429010000
	HDC MF 16B DA	1429030000

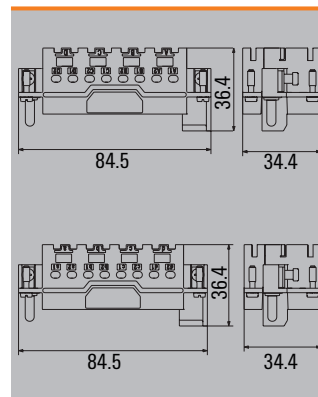

Note 4 module slots; double-sided PE screw connection: 0.5 - 10 mm² (AWG 20 ... 8); prepared conductor in accordance with IEC 60999-1

Frame with short guiding pin



Version	Type	Order No.
	HDC MFGS 16B AD	2736930000
	HDC MFGS 16B DA	2736940000

Note 4 module slots. With this variant, the PE connection on both sides is not required.

Frame with long guiding pin



Version	Type	Order No.
	HDC MFGL 16B AD	2737010000
	HDC MFGL 16B DA	2737020000

Note 4 module slots. With this variant, the PE connection on both sides is not required.

Transport lock



Transport lock for ModuPlug® metal frame		Order No.
HDC MF FIXING		1480290000

Size 8

ModuPlug® metal frame

Frame



Version	Type	Order No.
	HDC MF 24B AF	1429050000
	HDC MF 24B FA	1429070000

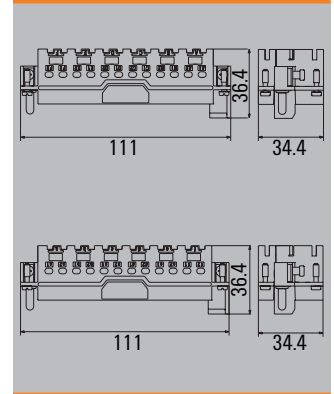

Note 6 module slots; double-sided PE screw connection: 0.5 - 10 mm² (AWG 20 ... 8); prepared conductor in accordance with IEC 60999-1

Frame with short guiding pin



Version	Type	Order No.
	HDC MFGS 24B AF	2736950000
	HDC MFGS 24B FA	2736960000



Note 6 module slots. With this variant, the PE connection on both sides is not required.

Frame with long guiding pin



Version	Type	Order No.
	HDC MFGL 24B AF	2737030000
	HDC MFGL 24B FA	2737040000



Note 6 module slots. With this variant, the PE connection on both sides is not required.

Transport lock



Transport lock for ModuPlug® metal frame	Order No.
HDC MF FIXING	1480290000

RockStar® ModuPlug modules

**ModuPlug®
HDC MHP 200
Crimp connection**

Technical data

Contact inserts	
Number of poles	1
Rated current (DIN EN 61984)	200 A
Rated voltage (DIN EN 61984)	1000 V
Rated impulse voltage (DIN EN 61984)	8 kV
Pollution severity	3
Rated voltage according to UL/CSA	600 V
Insulation strength	10 ¹² Ω
Surge voltage category	III
Limit temperature	-40 °C ... 125 °C
UL 94 flammability rating	V-0
Plugging cycles	≥ 500
Material	Polycarbonate, glass fibre reinforced
Required plug-in slots	1.5

Note

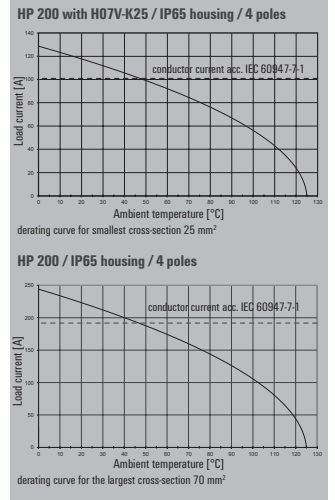

Crimp connection



Version	Type	Order No.
Male	HDC MHP 200 MC	2548900000
Female	HDC MHP 200 FC	2549260000

Note

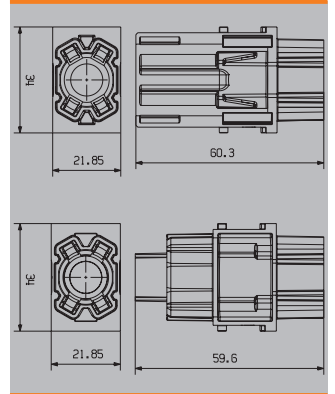

Accessories

Crimping contact

Surface finish silver



Male			Female		
Qty.	Type	Order No.	Type	Order No.	Order No.
10	HDC MHP200 M 25	2514860000	HDC MHP200 F 25	2514820000	2514820000
10	HDC MHP200 M 35	2514870000	HDC MHP200 F 35	2514830000	2514830000
10	HDC MHP200 M 50	2514880000	HDC MHP200 F 50	2514840000	2514840000
10	HDC MHP200 M 70	2514890000	HDC MHP200 F 70	2514850000	2514850000

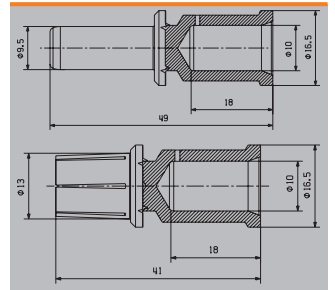

EPG 45



Contact Removal Tool	
HDC MHP200 REMOVAL TOOL	2617240000
Pressing tool	
EPG 45	1500830000
Note	

ModuPlug®
HDC MHP 200
 Axial screw connection

Technical data

Contact inserts	
Number of poles	1
Rated current (DIN EN 61984)	200 A
Rated voltage (DIN EN 61984)	1000 V
Rated impulse voltage (DIN EN 61984)	8 kV
Pollution severity	3
Rated voltage according to UL/CSA	600 V
Conductor cross-section	25...70 mm ²
Surge voltage category	III
Limit temperature	-40 °C ... 125 °C
UL 94 flammability rating	V-0
Plugging cycles	≥ 500
Material	Polycarbonate
Required plug-in slots	2

Note

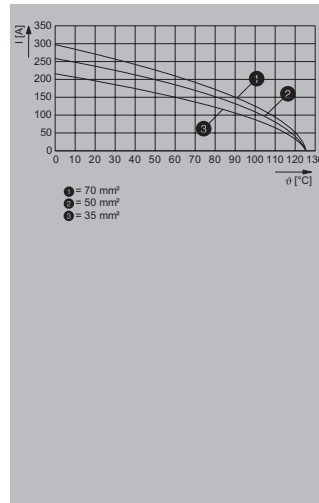

Axial screw connection



Version	Type	Order No.
Male	HDC MHP 200 MAS	2748240000
Female	HDC MHP 200 FAS	2748250000

Note A hexagon socket with SW5 is required for the axial screw contact.

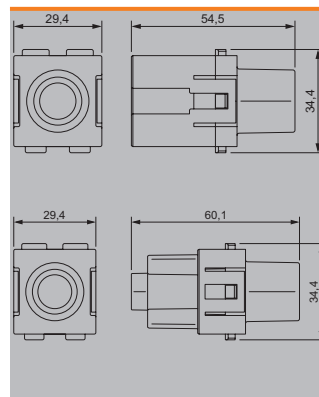

RockStar® ModuPlug modules

ModuPlug®
HDC MHP 200 PE

Axial screw connection

Technical data

Contact inserts

Number of poles	1
Conductor cross-section	25...70 mm ²
Limit temperature	-40 °C ... 125 °C
UL 94 flammability rating	V-0
Plugging cycles	≥ 500
Material	Polycarbonate
Required plug-in slots	2

Note

Axial screw connection



Version	Type	Order No.
Male	HDC MHP 200 PE MAS	2748260000
Female	HDC MHP 200 PE FAS	2748270000

Note

A hexagon socket with SW5 is required for the axial screw contact.

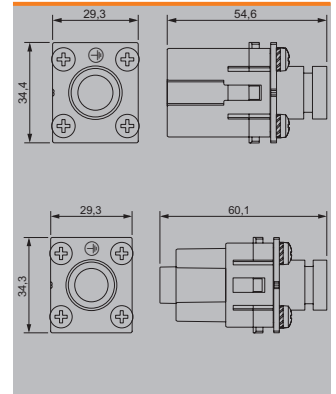

ModuPlug®
HDC MHP 100
Crimp connection

Technical data

Contact inserts	
Number of poles	2
Rated current (DIN EN 61984)	100 A
Rated voltage (DIN EN 61984)	1000 V
Rated impulse voltage (DIN EN 61984)	8 kV
Pollution severity	3
Rated voltage according to UL/CSA	600 V
Insulation strength	10 ¹² Ω
Surge voltage category	III
Limit temperature	-40 °C ... 125 °C
UL 94 flammability rating	V-0
Plugging cycles	≥ 500
Material	Polycarbonate, glass fibre reinforced
Required plug-in slots	1.5

Note

HDC-MHP100-modules in the IP65-housing, Conductor H07V-K10:

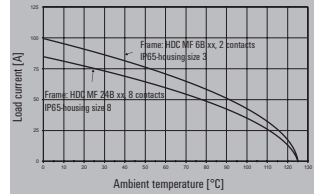

HDC-MHP100-modules in the IP65-housing, Conductor H07V-K35:

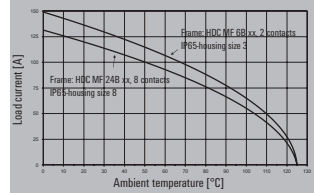

Crimp connection



Version	Type	Order No.
Male	HDC MHP 100 MC	1429060000
Female	HDC MHP 100 FC	1429080000

Note

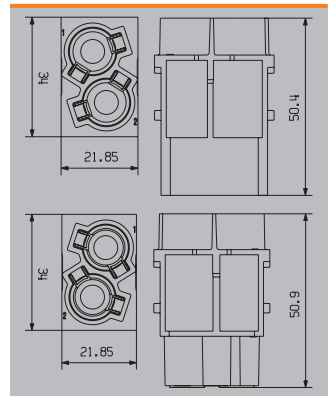

Accessories

Crimping contact

Surface finish silver



Male			Female		
Qty.	Type	Order No.	Type	Order No.	Order No.
10	HDC MHP100 M 10	1435750000	HDC MHP100 F 10	1435790000	1435790000
10	HDC MHP100 M 16	1435760000	HDC MHP100 F 16	1435810000	1435810000
10	HDC MHP100 M 25	1435770000	HDC MHP100 F 25	1435820000	1435820000
10	HDC MHP100 M 35	1435780000	HDC MHP100 F 35	1435830000	1435830000

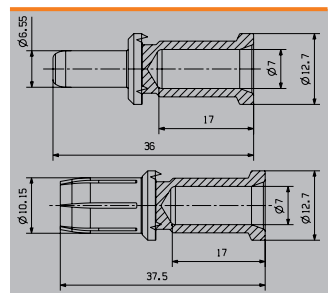

EPG 45



Contact Removal Tool	
HDC MHP100 REMOVAL TOOL	1480380000
Pressing tool	
EPG 45	1500830000
Note	

RockStar® ModuPlug modules

**ModuPlug®
HDC MHP 100
Axial screw connection**

Technical data

Contact inserts	
Number of poles	2
Rated current (DIN EN 61984)	100 A
Rated voltage (DIN EN 61984)	1000 V
Rated impulse voltage (DIN EN 61984)	8 kV
Pollution severity	3
Rated voltage according to UL/CSA	600 V
Conductor cross-section	10...35 mm ²
Surge voltage category	III
Limit temperature	-40 °C ... 125 °C
UL 94 flammability rating	V-0
Plugging cycles	≥ 500
Material	Polycarbonate
Required plug-in slots	2

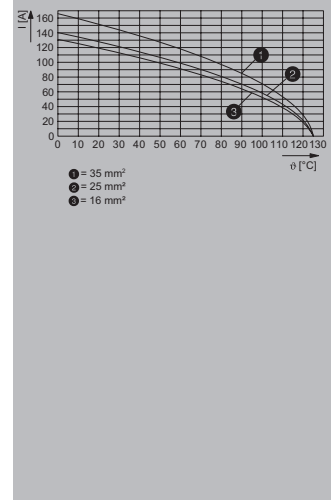

Note

Axial screw connection



Version	Type	Order No.
Male	HDC MHP 100 MAS	2748280000
Female	HDC MHP 100 FAS	2748290000

Note A hexagon socket with SW5 is required for the axial screw contact.

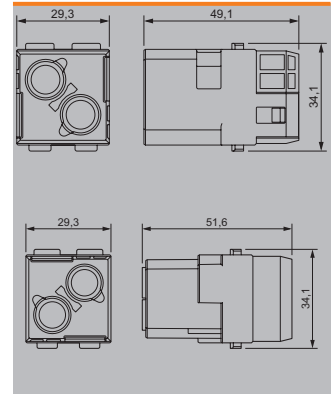

ModuPlug®
HDC MHE 2 HV
Crimp connection

Technical data

Contact inserts	
Number of poles	2
Rated current (DIN EN 61984)	16 A
Rated voltage (DIN EN 61984)	2900 V
Rated impulse voltage (DIN EN 61984)	15 kV
Pollution severity	3
Rated voltage according to UL/CSA	600 V
Surge voltage category	III
Limit temperature	-40 °C ... 125 °C
UL 94 flammability rating	V-0
Plugging cycles	≥ 500
Material	Polycarbonate
Required plug-in slots	2

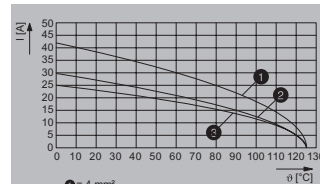

Note

Crimp connection



Version	Type	Order No.
Male	HDC MHE 2 HV MC	2748380000
Female	HDC MHE 2 HV FC	2748390000

Note

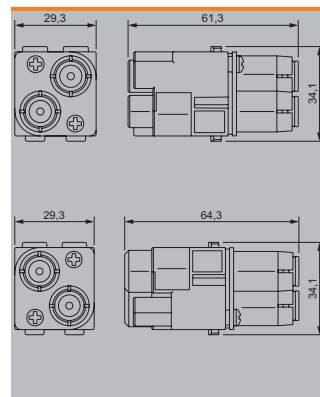

Accessories

Crimping contact

Surface finish gold



Surface finish silver



Male			Female		
Qty.	Type	Order No.	Type	Order No.	Order No.
100	HDC-C-HE-SM0.5AU	1651420000	HDC-C-HE-BM0.5AU	1651470000	1651470000
100	HDC-C-HE-SM0.75-1.00AU	1651430000	HDC-C-HE-BM0.75-1.00AU	1651480000	1651480000
100	HDC-C-HE-SM1.5AU	1651440000	HDC-C-HE-BM1.5AU	1651490000	1651490000
100	HDC-C-HE-SM2.5AU	1651450000	HDC-C-HE-BM2.5AU	1651500000	1651500000
100	HDC-C-HE-SM4.0AU	1651460000	HDC-C-HE-BM4.0AU	1651510000	1651510000
100	HDC-C-HE-SM4.65AU	1116540000	HDC-C-HE-BM4.65AU	1116530000	1116530000
100	HDC-C-HE-SM0.5AG	1200500000	HDC-C-HE-BM0.5AG	1201100000	1201100000
100	HDC-C-HE-SM0.75-1.00AG	1200600000	HDC-C-HE-BM0.75-1.00AG	1201200000	1201200000
100	HDC-C-HE-SM1.5AG	1200700000	HDC-C-HE-BM1.5AG	1201300000	1201300000
100	HDC-C-HE-SM2.5AG	1200800000	HDC-C-HE-BM2.5AG	1201400000	1201400000
100	HDC-C-HE-SM4.0AG	1200900000	HDC-C-HE-BM4.0AG	1201500000	1201500000



Conductor cross-section	Insulation stripping length
0.50 mm²	AWG 20 7.5 mm
0.75 - 1.00 mm²	AWG 18 7.5 mm
1.50 mm²	AWG 16 7.5 mm
2.50 mm²	AWG 14 7.5 mm
4.00 mm²	AWG 12 7.5 mm

Tools



Contact Removal Tool	
REMOVAL TOOL HE	1866750000
Pressing tool	
CTX CM 1.6/2.5	9018490000
CTIN CM 1.6/2.5	9205430000

Note Overview of the crimp inserts in the chapter RockStar® Accessories, tools and cable entries.

RockStar® ModuPlug modules

**ModuPlug®
HDC MHP 70
Crimp connection**

Technical data

Contact inserts	
Number of poles	2
Rated current (DIN EN 61984)	70 A
Rated voltage (DIN EN 61984)	1000 V
Rated impulse voltage (DIN EN 61984)	8 kV
Pollution severity	3
Rated voltage according to UL/CSA	600 V
Insulation strength	10 ¹² Ω
Surge voltage category	III
Limit temperature	-40 °C ... 125 °C
UL 94 flammability rating	V-0
Plugging cycles	≥ 500
Material	Polycarbonate, glass fibre reinforced
Required plug-in slots	1

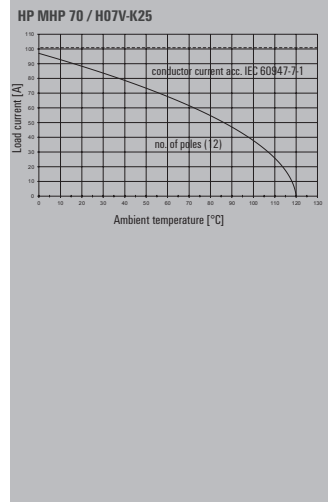

Note

Crimp connection



Version	Type	Order No.
Male	HDC MHP 70 MC	2668190000
Female	HDC MHP 70 FC	2668180000

Note

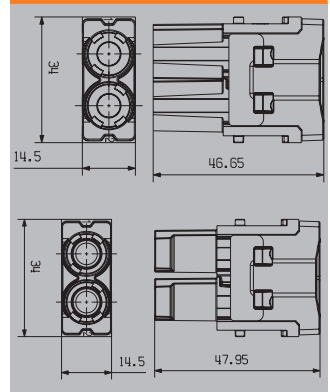

Accessories

Crimping contact

Surface finish silver

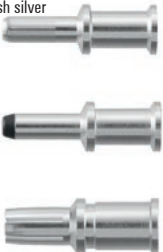

Male			Female		
Qty.	Type	Order No.	Type	Order No.	Order No.
10	HDC MHP70 M 6	2668280000	HDC MHP70 F 6	2668210000	
10	HDC MHP70 M 6 P	2691190000	HDC MHP70 F 10	2668200000	
10	HDC MHP70 M 10	2668350000	HDC MHP70 F 16	2668220000	
10	HDC MHP70 M 10 P	2691240000	HDC MHP70 F 25	2668260000	
10	HDC MHP70 M 16	2668360000			
10	HDC MHP70 M 16 P	2691250000			
10	HDC MHP70 M 25	2668370000			
10	HDC MHP70 M 25 P	2691260000			

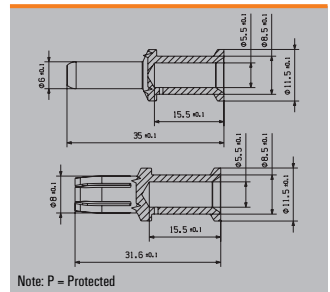

Note: P = Protected

EPG 45



Pressing tool	
EPG 45	1500830000

Note

ModuPlug®
HDC MHP 70
 Axial screw connection

Technical data

Contact inserts

Number of poles	2
Rated current (DIN EN 61984)	70 A
Rated voltage (DIN EN 61984)	1000 V
Rated impulse voltage (DIN EN 61984)	8 kV
Pollution severity	3
Rated voltage according to UL/CSA	600 V
Conductor cross-section	4...25 mm ²
Surge voltage category	III
Limit temperature	-40 °C ... 125 °C
UL 94 flammability rating	V-0
Plugging cycles	≥ 500
Material	Polycarbonate
Required plug-in slots	1

Note

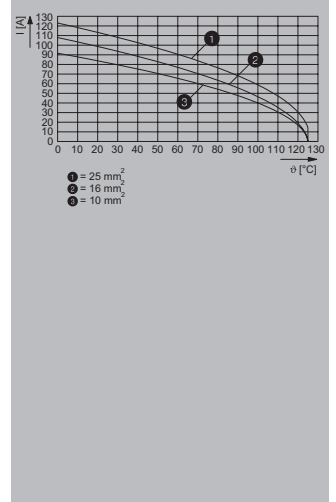

Axial screw connection



Version	Type	Order No.
Male	HDC MHP 70 MAS	2748300000
Female	HDC MHP 70 FAS	2748310000

Note A hexagon socket with SW2.5 is required for the axial screw contact.

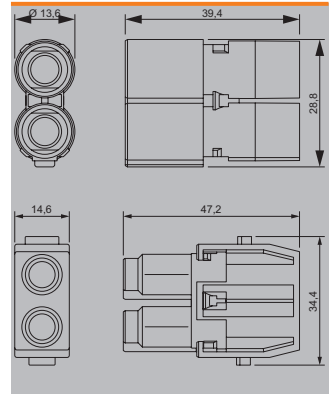

RockStar® ModuPlug modules

**ModuPlug®
HDC MHX 2
Crimp connection**

Technical data

Contact inserts	
Number of poles	2
Rated current (DIN EN 61984)	40 A
Rated voltage (DIN EN 61984)	830 V
Rated impulse voltage (DIN EN 61984)	8 kV
Pollution severity	3
Rated voltage according to UL/CSA	600 V
Surge voltage category	III
Limit temperature	-40 °C ... 125 °C
UL 94 flammability rating	V-0
Plugging cycles	≥ 500
Material	Polycarbonate
Required plug-in slots	1

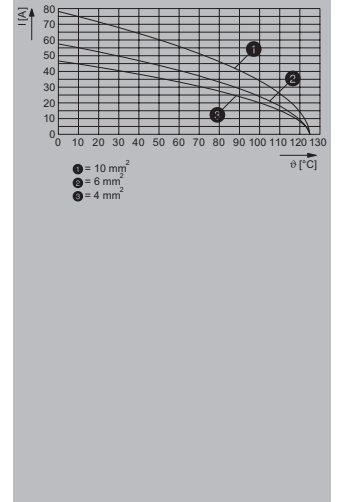

Note

Crimp connection



Version	Type	Order No.
Male	HDC MHX 2 MC	2748340000
Female	HDC MHX 2 FC	2748350000

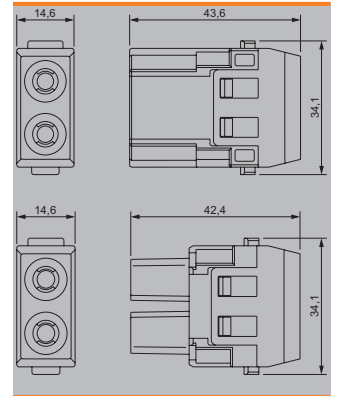

Note

Accessories

Crimping contact

Surface finish silver



Male			Female		
Qty.	Type	Order No.	Type	Order No.	Order No.
25	HDC C HX SM1.5AG	1002910000	HDC C HX BM1.5AG	1002950000	1002950000
25	HDC C HX SM2.5AG	1002920000	HDC C HX BM2.5AG	1002960000	1002960000
25	HDC C HX SM4.0AG	1002930000	HDC C HX BM4.0AG	1002970000	1002970000
25	HDC C HX SM6.0AG	1002940000	HDC C HX BM6.0AG	1002980000	1002980000
25	HDC C MHX SM10.0AG	2494550000	HDC C MHX BM10.0AG	2494560000	2494560000

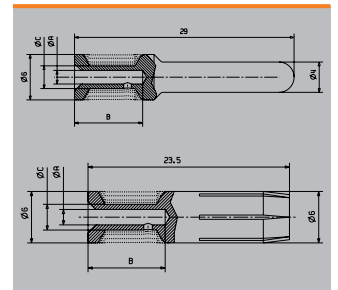

Tools



Contact Removal Tool	
REMOVAL TOOL HX	1002990000
Pressing tool	
CTIN CM 1.6/2.5	9205430000

Note Overview of the crimp inserts in the chapter RockStar® Accessories, tools and cable entries.

ModuPlug®
HDC MHX 2
 Axial screw connection

Technical data

Contact inserts	
Number of poles	2
Rated current (DIN EN 61984)	40 A
Rated voltage (DIN EN 61984)	690 V
Rated impulse voltage (DIN EN 61984)	8 kV
Pollution severity	3
Rated voltage according to UL/CSA	600 V
Conductor cross-section	2.5...10 mm ²
Surge voltage category	III
Limit temperature	-40 °C ... 125 °C
UL 94 flammability rating	V-0
Plugging cycles	≥ 500
Material	Polycarbonate
Required plug-in slots	1

Note

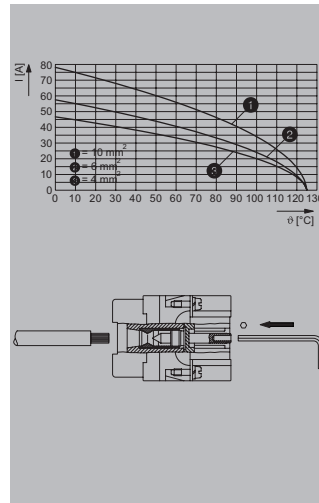

Axial screw connection



Version	Type	Order No.
Male	HDC MHX 2 MAS	2748320000
Female	HDC MHX 2 FAS	2748330000

Note

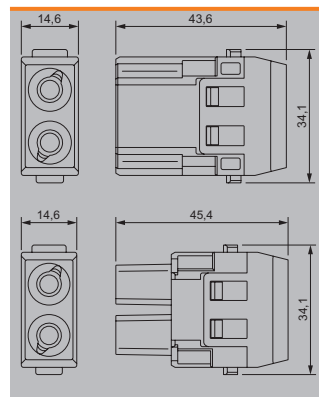

RockStar® ModuPlug modules

ModuPlug® HDC MHX 4P Crimp connection

Technical data

Contact inserts	
Number of poles	4
Rated current (DIN EN 61984)	40 A
Rated voltage (DIN EN 61984)	830 V
Rated impulse voltage (DIN EN 61984)	8 kV
Pollution severity	3
Rated voltage according to UL/CSA	600 V
Insulation strength	10 ¹² Ω
Surge voltage category	III
Limit temperature	-40 °C ... 125 °C
UL 94 flammability rating	V-0
Plugging cycles	≥ 500
Material	Polycarbonate, glass fibre reinforced
Required plug-in slots	1

Note

HDC-MHX 4P - modules in IP65 housing / H07V-K1.5 / 8 or 24 poles

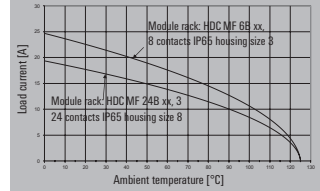

HDC-MHX 4P - modules in IP65 housing / H07V-K6.0 / 8 or 24 poles

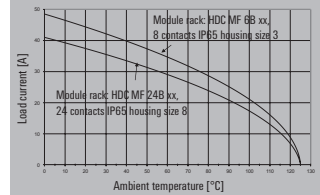

Crimp connection



Version	Type	Order No.
Pin	HDC MHX 4P MC	1428950000
Female	HDC MHX 4P FC	1428970000

Note

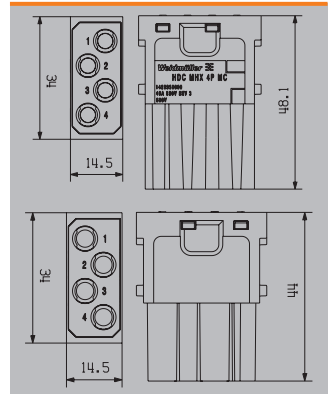

Accessories

Crimping contact

Surface finish silver



Male			Female		
Qty.	Type	Order No.	Type	Order No.	Order No.
25	HDC C HX SM1.5AG	1002910000	HDC C HX BM1.5AG	1002950000	1002950000
25	HDC C HX SM2.5AG	1002920000	HDC C HX BM2.5AG	1002960000	1002960000
25	HDC C HX SM4.0AG	1002930000	HDC C HX BM4.0AG	1002970000	1002970000
25	HDC C HX SM6.0AG	1002940000	HDC C HX BM6.0AG	1002980000	1002980000

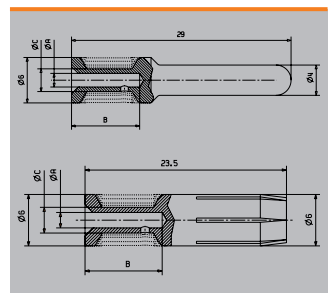

Tools



Contact Removal Tool	
REMOVAL TOOL HX	1002990000
Pressing tool	
CTIN CM 1.6/2.5	9205430000
Note	Overview of the crimp inserts in the chapter RockStar® Accessories, tools and cable entries.

ModuPlug®
HDC MHX 4P
PUSH IN connection

Technical data

Contact inserts	
Number of poles	4
Rated current (DIN EN 61984)	40 A
Rated voltage (DIN EN 61984)	830 V
Rated impulse voltage (DIN EN 61984)	8 kV
Pollution severity	3
Conductor cross-section	2.5...66
Insulation strength	10 ¹² Ω
Surge voltage category	III
Limit temperature	-40 °C ... 125 °C
UL 94 flammability rating	V-0
Plugging cycles	≥ 500
Material	Polycarbonate
Required plug-in slots	1

Note

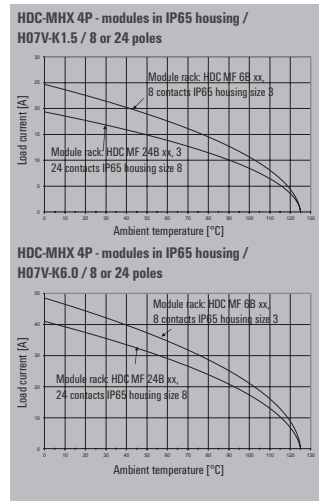

PUSH IN with actuator



Version	Type	Order No.
Male	HDC MHX 4 MP	2772800000
Female	HDC MHX 4 FP	2772810000

Note

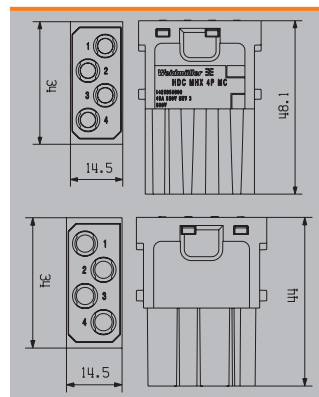

RockStar® ModuPlug modules

**ModuPlug®
HDC MHX 3
Crimp connection**

Technical data

Contact inserts	
Number of poles	3
Rated current (DIN EN 61984)	40 A
Rated voltage (DIN EN 61984)	690 V
Rated impulse voltage (DIN EN 61984)	8 kV
Pollution severity	3
Rated voltage according to UL/CSA	600 V
Insulation strength	10 ¹² Ω
Surge voltage category	III
Limit temperature	-40 °C ... 125 °C
UL 94 flammability rating	V-0
Plugging cycles	≥ 500
Material	Polycarbonate, glass fibre reinforced
Required plug-in slots	1

Note

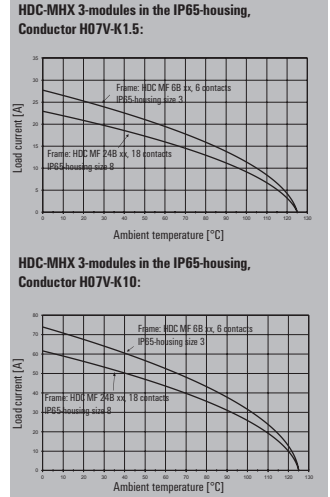

Crimp connection



Version	Type	Order No.
Pin	HDC MHX 3 MC	1429340000
Female	HDC MHX 3 FC	1429350000

Note

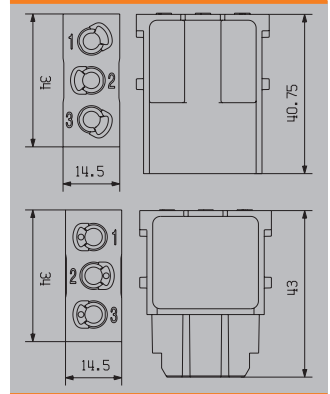

Accessories

Crimping contact

Surface finish silver



Male			Female		
Qty.	Type	Order No.	Type	Order No.	Order No.
25	HDC C HX SM1.5AG	1002910000	HDC C HX BM1.5AG	1002950000	1002950000
25	HDC C HX SM2.5AG	1002920000	HDC C HX BM2.5AG	1002960000	1002960000
25	HDC C HX SM4.0AG	1002930000	HDC C HX BM4.0AG	1002970000	1002970000
25	HDC C HX SM6.0AG	1002940000	HDC C HX BM6.0AG	1002980000	1002980000
25	HDC C MHX SM10.0AG	2494550000	HDC C MHX BM10.0AG	2494560000	2494560000

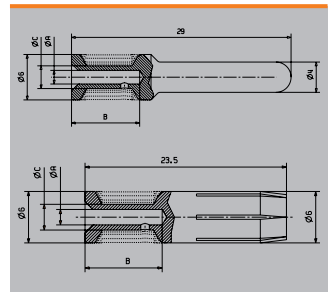

Tools



Contact Removal Tool	
REMOVAL TOOL HX	1002990000
Pressing tool	
CTIN CM 1.6/2.5	9205430000

Note Overview of the crimp inserts in the chapter RockStar® Accessories, tools and cable entries.

ModuPlug®
HDC MHX 3
PUSH IN connection

Technical data

Contact inserts	
Number of poles	3
Rated current (DIN EN 61984)	40 A
Rated voltage (DIN EN 61984)	690 V
Rated impulse voltage (DIN EN 61984)	8 kV
Pollution severity	3
Conductor cross-section	2.5...6 mm ²
Insulation strength	10 ¹² Ω
Surge voltage category	III
Limit temperature	-40 °C ... 125 °C
UL 94 flammability rating	V-0
Plugging cycles	≥ 500
Material	Polycarbonate
Required plug-in slots	1

Note

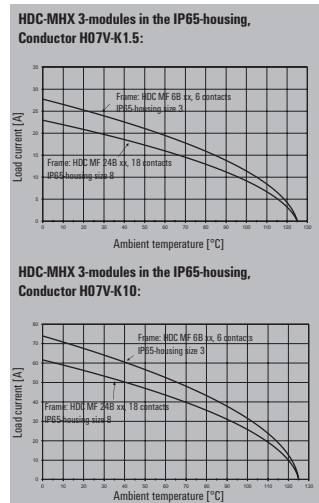

PUSH IN with actuator



Version	Type	Order No.
Male	HDC MHX 3 MP	2772780000
Female	HDC MHX 3 FP	2772790000

Note

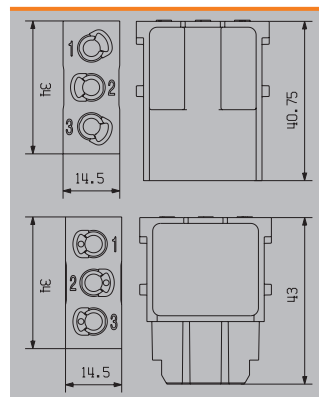

RockStar® ModuPlug modules

ModuPlug® HDC MHX 3/4 Crimp connection

Technical data

Power contact	
Clamping range, power contact, min.	1.5...6 mm ²
Number of poles, performance contact	3
Rated current (DIN EN 61984), power contact	40 A
Rated impulse voltage (DIN EN 61984), power contact	8 kV
Rated voltage (DIN EN 61984), power contact	500 V
Stripping length, performance contact	9 mm
Signal contact	
Clamping range, signal contact, min.	0.14...2.5 mm ²
Number of poles, signal	4
Rated current (DIN EN 61984), signal	10 A
Rated impulse voltage (DIN EN 61984), signal	8 kV
Rated voltage (DIN EN 61984), signal contact	500 V
Stripping length, signal	8 mm

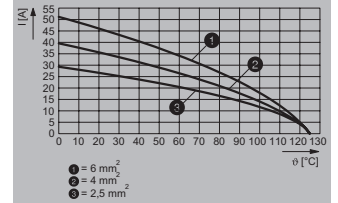

Note

Crimp connection



Version	Type	Order No.
Male	HDC MHX 3/4 MC	2748360000
Female	HDC MHX 3/4 FC	2748370000

Hinweis

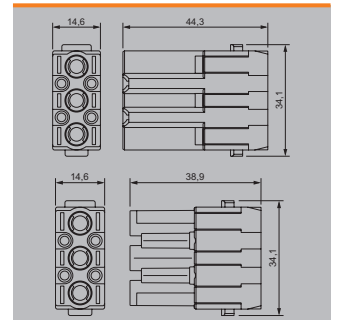

Accessories

Crimping contact

Surface finish gold



Surface finish silver



Surface finish silver



Male			Female		
Qty.	Type	Order No.	Type	Order No.	Order No.
100	HDC-C-HD-SM0.14-0.37AU	1651620000	HDC-C-HD-BM0.14-0.37AU	1651670000	
100	HDC-C-HD-SM0.5AU	1651630000	HDC-C-HD-BM0.5AU	1651680000	
100	HDC-C-HD-SM0.75-1.00AU	1651640000	HDC-C-HD-BM0.75-1.00AU	1651690000	
100	HDC-C-HD-SM1.5AU	1651650000	HDC-C-HD-BM1.5AU	1651700000	
100	HDC-C-HD-SM2.5AU	1651660000	HDC-C-HD-BM2.5AU	1651710000	
100	HDC-C-HD-SM0.14-0.37AG	1651520000	HDC-C-HD-BM0.14-0.37AG	1651570000	
100	HDC-C-HD-SM0.5AG	1651530000	HDC-C-HD-BM0.5AG	1651580000	
100	HDC-C-HD-SM0.75-1.00AG	1601750000	HDC-C-HD-BM0.75-1.00AG	1601760000	
100	HDC-C-HD-SM1.5AG	1651550000	HDC-C-HD-BM1.5AG	1651600000	
100	HDC-C-HD-SM2.5AG	1651560000	HDC-C-HD-BM2.5AG	1651610000	
25	HDC C HX SM1.5AG	1002910000	HDC C HX BM1.5AG	1002950000	
25	HDC C HX SM2.5AG	1002920000	HDC C HX BM2.5AG	1002960000	
25	HDC C HX SM4.0AG	1002930000	HDC C HX BM4.0AG	1002970000	
25	HDC C HX SM6.0AG	1002940000	HDC C HX BM6.0AG	1002980000	

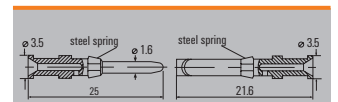

Conductor cross-section	Insulation stripping length	
0.14 - 0.37 mm ²	AWG 26-22	8 mm
0.50 mm ²	AWG 20	8 mm
0.75 - 1.00 mm ²	AWG 18	8 mm
1.50 mm ²	AWG 16	8 mm
2.50 mm ²	AWG 14	6 mm

Tools



Crimping tool	
CTX CM 1.6/2.5	9018490000
CTIN CM 1.6/2.5*	9205430000
Contact removal tool	
REMOVAL TOOL HD	1866730000
REMOVAL TOOL HX	1002990000

Note *for the power jumper contacts (HDC C HX...)

ModuPlug®
HDC MHE 6P
Crimp connection

Technical data

Contact inserts	
Number of poles	6
Rated current (DIN EN 61984)	16 A
Rated voltage (DIN EN 61984)	830 V
Rated impulse voltage (DIN EN 61984)	8 kV
Pollution severity	3
Rated voltage according to UL/CSA	600 V
Insulation strength	10 ¹² Ω
Surge voltage category	III
Limit temperature	-40 °C ... 125 °C
UL 94 flammability rating	V-0
Plugging cycles	≥ 500
Material	Polycarbonate, glass fibre reinforced
Required plug-in slots	1

Note

HDC-MHE 6P-modules in the IP65-housing,
Conductor H05V-K0.5:

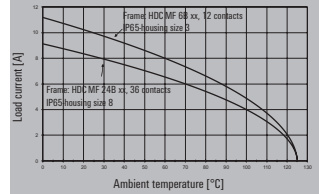

HDC-MHE 6P-modules in the IP65-housing,
Conductor H07V-K4.0:

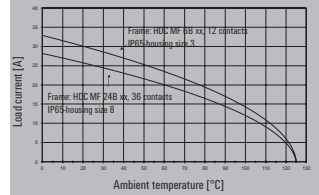

Crimp connection



Version	Type	Order No.
Male	HDC MHE 6P MC	1505650000
Female	HDC MHE 6P FC	1505660000

Note

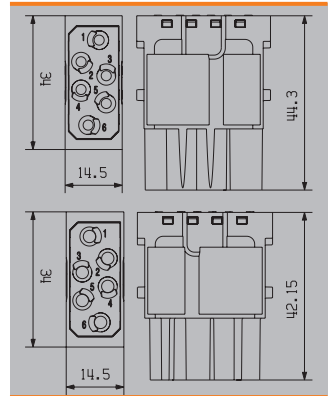

Accessories

Crimping contact

Surface finish gold



Surface finish silver



Male			Female		
Qty.	Type	Order No.	Type	Order No.	Order No.
100	HDC-C-HE-SM0.5AU	1651420000	HDC-C-HE-BM0.5AU	1651470000	
100	HDC-C-HE-SM0.75-1.00AU	1651430000	HDC-C-HE-BM0.75-1.00AU	1651480000	
100	HDC-C-HE-SM1.5AU	1651440000	HDC-C-HE-BM1.5AU	1651490000	
100	HDC-C-HE-SM2.5AU	1651450000	HDC-C-HE-BM2.5AU	1651500000	
100	HDC-C-HE-SM4.0AU	1651460000	HDC-C-HE-BM4.0AU	1651510000	
100	HDC-C-HE-SM4.65AU	1116540000	HDC-C-HE-BM4.65AU	1116530000	
100	HDC-C-HE-SM0.5AG	1200500000	HDC-C-HE-BM0.5AG	1201100000	
100	HDC-C-HE-SM0.75-1.00AG	1200600000	HDC-C-HE-BM0.75-1.00AG	1201200000	
100	HDC-C-HE-SM1.5AG	1200700000	HDC-C-HE-BM1.5AG	1201300000	
100	HDC-C-HE-SM2.5AG	1200800000	HDC-C-HE-BM2.5AG	1201400000	
100	HDC-C-HE-SM4.0AG	1200900000	HDC-C-HE-BM4.0AG	1201500000	

Conductor cross-section	Insulation stripping length
0.50 mm ²	AWG 20 7.5 mm
0.75 - 1.00 mm ²	AWG 18 7.5 mm
1.50 mm ²	AWG 16 7.5 mm
2.50 mm ²	AWG 14 7.5 mm
4.00 mm ²	AWG 12 7.5 mm

Tools



Contact Removal Tool	
REMOVAL TOOL HE	1866750000
Pressing tool	
CTX CM 1.6/2.5	9018490000
CTIN CM 1.6/2.5	9205430000

Note Overview of the crimp inserts in the chapter RockStar® Accessories, tools and cable entries.

RockStar® ModuPlug modules

**ModuPlug®
HDC MHE 20
Crimp connection**

Technical data

Contact inserts	
Number of poles	20
Rated current (DIN EN 61984)	16 A
Rated voltage (DIN EN 61984)	500 V
Rated impulse voltage (DIN EN 61984)	6 kV
Pollution severity	3
Rated voltage according to UL/CSA	600 V
Insulation strength	10 ¹² Ω
Surge voltage category	III
Limit temperature	-40 °C ... 125 °C
UL 94 flammability rating	V-0
Plugging cycles	≥ 500
Material	Polycarbonate, glass fibre reinforced
Required plug-in slots	2

Note

**HDC-MHE 20-modules in the IP65-housing,
Conductor H05V-K0.5:**

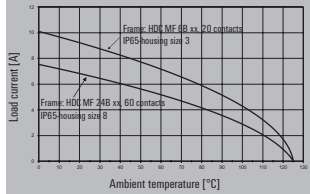

**HDC-MHE 20-moduls in the IP65-housing,
Conductor H07V-K4.0:**

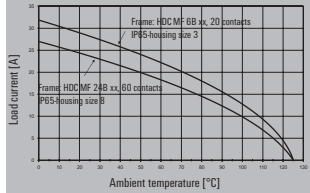

Crimp connection



Version	Type	Order No.
Male	HDC MHE 20 MC	1428910000
Female	HDC MHE 20 FC	1428930000

Note

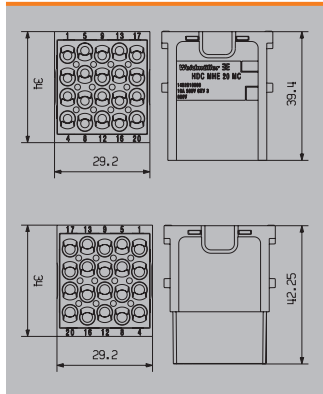

Accessories

Crimping contact

Surface finish gold



Surface finish silver



Male			Female		
Qty.	Type	Order No.	Type	Order No.	Order No.
100	HDC-C-HE-SM0.5AU	1651420000	HDC-C-HE-BM0.5AU	1651470000	
100	HDC-C-HE-SM0.75-1.00AU	1651430000	HDC-C-HE-BM0.75-1.00AU	1651480000	
100	HDC-C-HE-SM1.5AU	1651440000	HDC-C-HE-BM1.5AU	1651490000	
100	HDC-C-HE-SM2.5AU	1651450000	HDC-C-HE-BM2.5AU	1651500000	
100	HDC-C-HE-SM4.0AU	1651460000	HDC-C-HE-BM4.0AU	1651510000	
100	HDC-C-HE-SM4.65AU	1116540000	HDC-C-HE-BM4.65AU	1116530000	
100	HDC-C-HE-SM0.5AG	1200500000	HDC-C-HE-BM0.5AG	1201100000	
100	HDC-C-HE-SM0.75-1.00AG	1200600000	HDC-C-HE-BM0.75-1.00AG	1201200000	
100	HDC-C-HE-SM1.5AG	1200700000	HDC-C-HE-BM1.5AG	1201300000	
100	HDC-C-HE-SM2.5AG	1200800000	HDC-C-HE-BM2.5AG	1201400000	
100	HDC-C-HE-SM4.0AG	1200900000	HDC-C-HE-BM4.0AG	1201500000	



Conductor cross-section	Insulation stripping length
0.50 mm ²	AWG 20 7.5 mm
0.75 - 1.00 mm ²	AWG 18 7.5 mm
1.50 mm ²	AWG 16 7.5 mm
2.50 mm ²	AWG 14 7.5 mm
4.00 mm ²	AWG 12 7.5 mm

Tools



Contact Removal Tool	
REMOVAL TOOL HE	1866750000
Pressing tool	
CTX CM 1.6/2.5	9018490000
CTIN CM 1.6/2.5	9205430000

Note Overview of the crimp inserts in the chapter RockStar® Accessories, tools and cable entries.

ModuPlug®
HDC MHE 8
Crimp connection

Technical data

Contact inserts	
Number of poles	8
Rated current (DIN EN 61984)	16 A
Rated voltage (DIN EN 61984)	400 V
Rated impulse voltage (DIN EN 61984)	6 kV
Pollution severity	3
Rated voltage according to UL/CSA	600 V
Insulation strength	10 ¹² Ω
Surge voltage category	III
Limit temperature	-40 °C ... 125 °C
UL 94 flammability rating	V-0
Plugging cycles	≥ 500
Material	Polycarbonate, glass fibre reinforced
Required plug-in slots	1

Note

HDC-MHE 8-modules in the IP65-housing, Conductor H05V-K0.5:

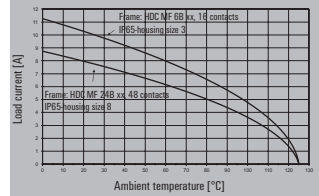

HDC-MHE 8-modules in the IP65-housing, Conductor H07V-K4.0:

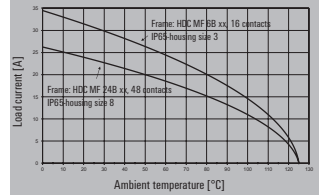

Crimp connection



Version	Type	Order No.
Male	HDC MHE 8 MC	1428880000
Female	HDC MHE 8 FC	1428890000

Note

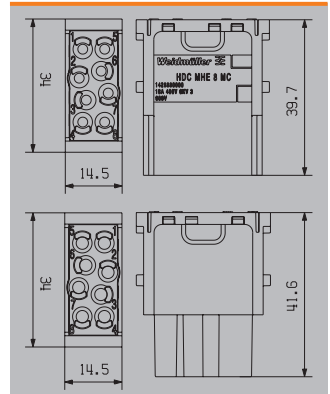

Accessories

Crimping contact

Surface finish gold



Surface finish silver



Male			Female		
Qty.	Type	Order No.	Type	Order No.	Order No.
100	HDC-C-HE-SM0.5AU	1651420000	HDC-C-HE-BM0.5AU	1651470000	1651470000
100	HDC-C-HE-SM0.75-1.00AU	1651430000	HDC-C-HE-BM0.75-1.00AU	1651480000	1651480000
100	HDC-C-HE-SM1.5AU	1651440000	HDC-C-HE-BM1.5AU	1651490000	1651490000
100	HDC-C-HE-SM2.5AU	1651450000	HDC-C-HE-BM2.5AU	1651500000	1651500000
100	HDC-C-HE-SM4.0AU	1651460000	HDC-C-HE-BM4.0AU	1651510000	1651510000
100	HDC-C-HE-SM4.65AU	1116540000	HDC-C-HE-BM4.65AU	1116530000	1116530000
100	HDC-C-HE-SM0.5AG	1200500000	HDC-C-HE-BM0.5AG	1201100000	1201100000
100	HDC-C-HE-SM0.75-1.00AG	1200600000	HDC-C-HE-BM0.75-1.00AG	1201200000	1201200000
100	HDC-C-HE-SM1.5AG	1200700000	HDC-C-HE-BM1.5AG	1201300000	1201300000
100	HDC-C-HE-SM2.5AG	1200800000	HDC-C-HE-BM2.5AG	1201400000	1201400000
100	HDC-C-HE-SM4.0AG	1200900000	HDC-C-HE-BM4.0AG	1201500000	1201500000

Conductor cross-section	Insulation stripping length
0.50 mm ²	AWG 20 7.5 mm
0.75 - 1.00 mm ²	AWG 18 7.5 mm
1.50 mm ²	AWG 16 7.5 mm
2.50 mm ²	AWG 14 7.5 mm
4.00 mm ²	AWG 12 7.5 mm

Tools



Contact Removal Tool	
REMOVAL TOOL HE	1866750000
Pressing tool	
CTX CM 1.6/2.5	9018490000
CTIN CM 1.6/2.5	9205430000

Note Overview of the crimp inserts in the chapter RockStar® Accessories, tools and cable entries.

RockStar® ModuPlug modules

ModuPlug®
HDC MHE 8
PUSH IN connection
Technical data

Contact inserts

Number of poles	8
Rated current (DIN EN 61984)	16 A
Rated voltage (DIN EN 61984)	400 V
Rated impulse voltage (DIN EN 61984)	6 kV
Pollution severity	3
Conductor cross-section	0.5...2.5 mm ²
Surge voltage category	III
Limit temperature	-40 °C ... 125 °C
UL 94 flammability rating	V-0
Plugging cycles	≥ 500
Material	Polycarbonate
Required plug-in slots	1

Note
PUSH IN with actuator

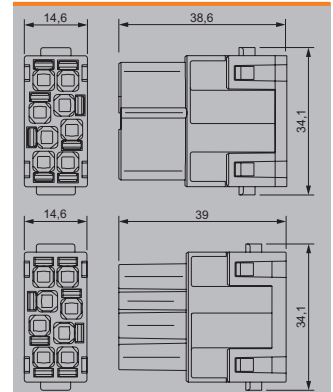

Version	Type	Order No.
Male	HDC MHE 8 MP	2748440000
Female	HDC MHE 8 FP	2748450000

Note

ModuPlug®
HDC MHE 6
Crimp connection

Technical data

Contact inserts	
Number of poles	6
Rated current (DIN EN 61984)	16 A
Rated voltage (DIN EN 61984)	500 V
Rated impulse voltage (DIN EN 61984)	6 kV
Pollution severity	3
Rated voltage according to UL/CSA	600 V
Insulation strength	10 ¹² Ω
Surge voltage category	III
Limit temperature	-40 °C ... 125 °C
UL 94 flammability rating	V-0
Plugging cycles	≥ 500
Material	Polycarbonate, glass fibre reinforced
Required plug-in slots	1

Note

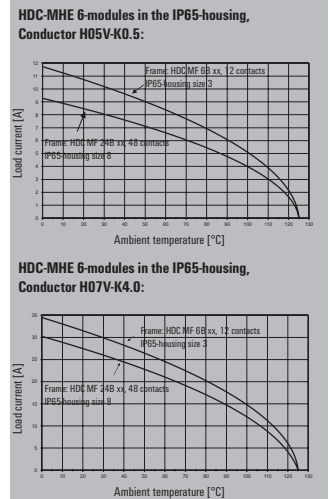

Crimp connection



Version	Type	Order No.
Male	HDC MHE 6 MC	1429360000
Female	HDC MHE 6 FC	1429370000

Note

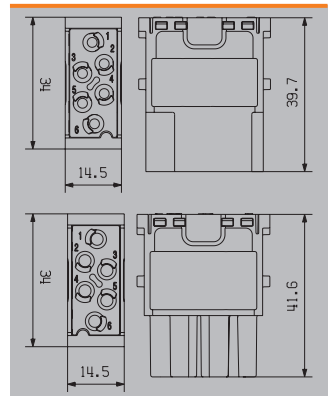

Accessories

Crimping contact

Surface finish gold



Surface finish silver



Male			Female		
Qty.	Type	Order No.	Type	Order No.	Order No.
100	HDC-C-HE-SM0.5AU	1651420000	HDC-C-HE-BM0.5AU	1651470000	1651470000
100	HDC-C-HE-SM0.75-1.00AU	1651430000	HDC-C-HE-BM0.75-1.00AU	1651480000	1651480000
100	HDC-C-HE-SM1.5AU	1651440000	HDC-C-HE-BM1.5AU	1651490000	1651490000
100	HDC-C-HE-SM2.5AU	1651450000	HDC-C-HE-BM2.5AU	1651500000	1651500000
100	HDC-C-HE-SM4.0AU	1651460000	HDC-C-HE-BM4.0AU	1651510000	1651510000
100	HDC-C-HE-SM4.65AU	1116540000	HDC-C-HE-BM4.65AU	1116530000	1116530000
100	HDC-C-HE-SM0.5AG	1200500000	HDC-C-HE-BM0.5AG	1201100000	1201100000
100	HDC-C-HE-SM0.75-1.00AG	1200600000	HDC-C-HE-BM0.75-1.00AG	1201200000	1201200000
100	HDC-C-HE-SM1.5AG	1200700000	HDC-C-HE-BM1.5AG	1201300000	1201300000
100	HDC-C-HE-SM2.5AG	1200800000	HDC-C-HE-BM2.5AG	1201400000	1201400000
100	HDC-C-HE-SM4.0AG	1200900000	HDC-C-HE-BM4.0AG	1201500000	1201500000

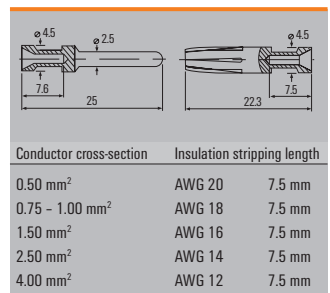

Tools



Contact Removal Tool	
REMOVAL TOOL HE	1866750000
Pressing tool	
CTX CM 1.6/2.5	9018490000
CTIN CM 1.6/2.5	9205430000

Note Overview of the crimp inserts in the chapter RockStar® Accessories, tools and cable entries.

RockStar® ModuPlug modules

**ModuPlug®
HDC MHE 6
PUSH IN connection**

Technical data

Contact inserts	
Number of poles	6
Rated current (DIN EN 61984)	16 A
Rated voltage (DIN EN 61984)	500 V
Rated impulse voltage (DIN EN 61984)	6 kV
Pollution severity	3
Conductor cross-section	0.5...2.5 mm ²
Surge voltage category	III
Limit temperature	-40 °C ... 125 °C
UL 94 flammability rating	V-0
Plugging cycles	≥ 500
Material	Polycarbonate
Required plug-in slots	1

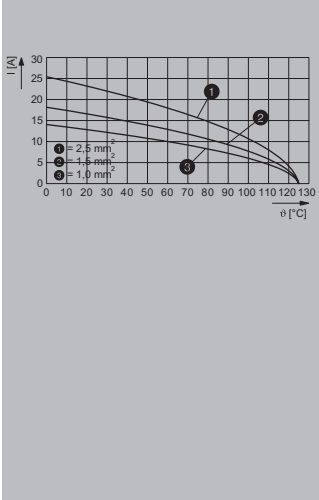

Note

PUSH IN with actuator



Version	Type	Order No.
Male	HDC MHE 6 MP	2748420000
Female	HDC MHE 6 FP	2748430000

Note

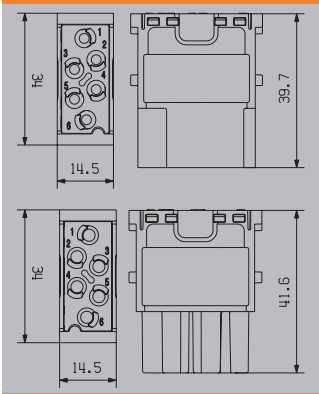

ModuPlug®
HDC MHE 5
PUSH IN connection

Technical data

Contact inserts	
Number of poles	5
Rated current (DIN EN 61984)	16 A
Rated voltage (DIN EN 61984)	400 V
Rated impulse voltage (DIN EN 61984)	6 kV
Pollution severity	3
Line connection cross-section	0.5...2.5 mm ²
Rated voltage according to UL/CSA	600 V
Insulation strength	10 ¹² Ω
Surge voltage category	III
Limit temperature	-40 °C ... 125 °C
UL 94 flammability rating	V-0
Plugging cycles	≥ 500
Material	Polycarbonate, glass fibre reinforced
Required plug-in slots	1

Note

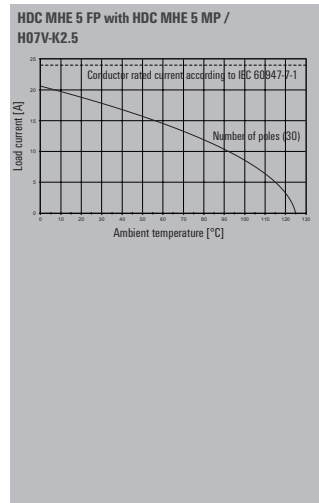

PUSH IN with actuator



Version	Type	Order No.
Male	HDC MHE 5 MP	2636180000
Female	HDC MHE 5 FP	2636190000

Note

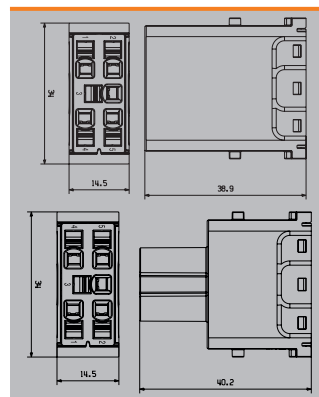

RockStar® ModuPlug modules

ModuPlug®
HDC MHE 5L
PUSH IN connection
Technical data

Contact inserts	
Number of poles	5
Rated current (DIN EN 61984)	16 A
Rated voltage (DIN EN 61984)	230 V
Rated impulse voltage (DIN EN 61984)	4 kV
Pollution severity	3
Rated voltage according to UL/CSA	600 V
Conductor cross-section	0.25...1.5 mm ²
Surge voltage category	III
Limit temperature	-40 °C ... 125 °C
UL 94 flammability rating	V-0
Plugging cycles	≥ 500
Material	Polycarbonate
Required plug-in slots	1

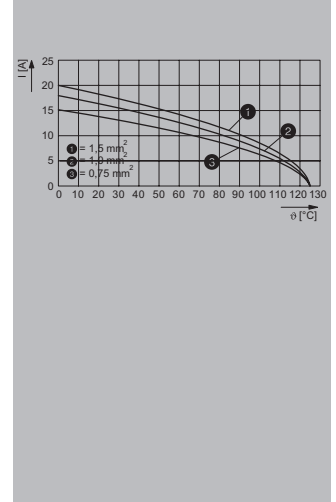
Note

PUSH IN with actuator



Version	Type	Order No.
Male	HDC MHE 5L MP	274840000
Female	HDC MHE 5L FP	274841000

Note

ModuPlug®
HDC MHE 4
PUSH IN connection

Technical data

Contact inserts	
Number of poles	4
Number of potentials	4
Rated current (DIN EN 61984)	16 A
Rated voltage (DIN EN 61984)	250 V
Rated impulse voltage (DIN EN 61984)	4 kV
Pollution severity	3
Rated voltage according to UL/CSA	600 V
Insulation strength	10 ¹² Ω
Surge voltage category	III
Limit temperature	-40 °C ... 125 °C
UL 94 flammability rating	V-0
Plugging cycles	≥ 500
Material	Polycarbonate, glass fibre reinforced
Required plug-in slots	0.5
Line connection cross-section	0.5...2.5 mm ²
Note	

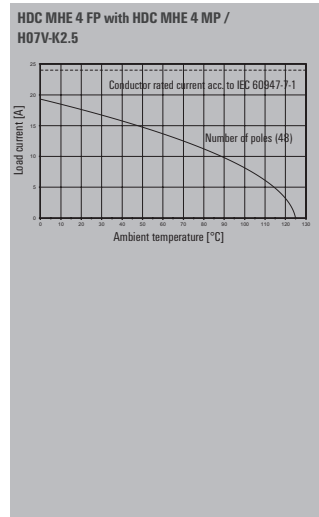

PUSH IN with actuator



Version	Type	Order No.
Male	HDC MHE 4 MP	2635980000
Female	HDC MHE 4 FP	2635990000
Note		

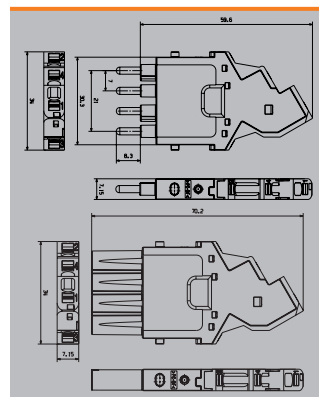

RockStar® ModuPlug modules

ModuPlug®
HDC MHE 4X
PUSH IN connection
Technical data

Contact inserts	
Number of poles	4
Number of potentials	4
Rated current (DIN EN 61984)	16 A
Rated voltage (DIN EN 61984)	250 V
Rated impulse voltage (DIN EN 61984)	4 kV
Pollution severity	3
Rated voltage according to UL/CSA	600 V
Insulation strength	10 ¹² Ω
Surge voltage category	III
Limit temperature	-40 °C ... 125 °C
UL 94 flammability rating	V-0
Plugging cycles	≥ 500
Material	Polycarbonate, glass fibre reinforced
Required plug-in slots	0.5
Line connection cross-section	0.5...2.5 mm ²
Note	

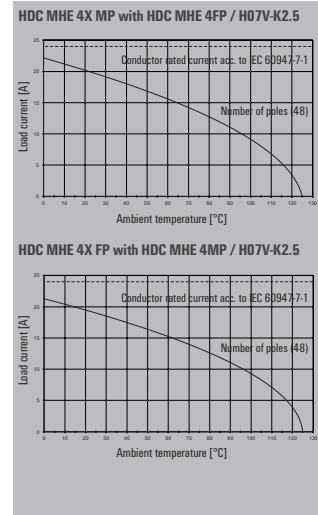
PUSH IN with actuator

Version	Type	Order No.
Pin	HDC MHE 4X MP	2636070000
Female	HDC MHE 4X FP	2636060000

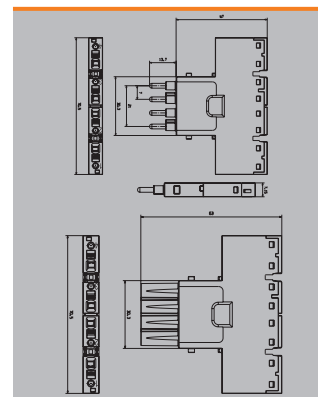
Note

Accessories

Cross connections	
HDC MXCC2 4X	2709710000
HDC MXCC3 4X	2709720000
HDC MXCC4 4X	2709730000
HDC MXCC5 4X	2709740000
HDC MXCC6 4X	2709750000
HDC MXCC7 4X	2709770000
HDC MXCC8 4X	2709780000
HDC MXCC9 4X	2709790000
HDC MXCC10 4X	2709800000
HDC MXCC11 4X	2709810000
HDC MXCC12 4X	2709820000
Markers	
HDC MMARK 4	2710590000
Note	

ModuPlug®
HDC MHE 4X2
PUSH IN connection

Technical data

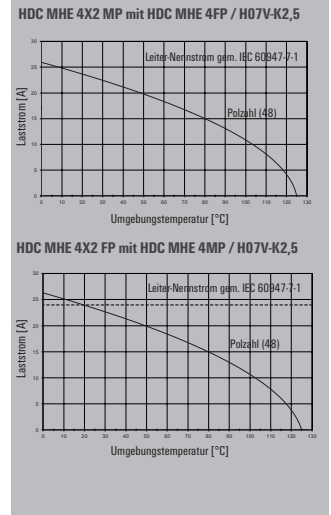
Contact inserts	
Number of poles	4
Number of potentials	2
Rated current (DIN EN 61984)	16 A
Rated voltage (DIN EN 61984)	250 V
Rated impulse voltage (DIN EN 61984)	4 kV
Pollution severity	3
Rated voltage according to UL/CSA	600 V
Insulation strength	10 ¹² Ω
Surge voltage category	III
Limit temperature	-40 °C ... 125 °C
UL 94 flammability rating	V-0
Plugging cycles	≥ 500
Material	Polycarbonate, glass fibre reinforced
Required plug-in slots	0.5
Line connection cross-section	0.5...2.5 mm ²
Note	



PUSH IN with actuator



Version	Type	Order No.
Pin	HDC MHE 4X2 MP	2636090000
Female	HDC MHE 4X2 FP	2636080000

Note

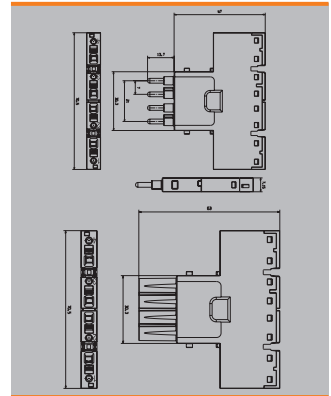

Accessories



Cross connections	
HDC MXCC2 4X	2709710000
HDC MXCC3 4X	2709720000
HDC MXCC4 4X	2709730000
HDC MXCC5 4X	2709740000
HDC MXCC6 4X	2709750000
HDC MXCC7 4X	2709770000
HDC MXCC8 4X	2709780000
HDC MXCC9 4X	2709790000
HDC MXCC10 4X	2709800000
HDC MXCC11 4X	2709810000
HDC MXCC12 4X	2709820000

Markers	
HDC MMARK 4	2710590000

Note

RockStar® ModuPlug modules

**ModuPlug®
HDC MHD 36
Crimp connection**

Technical data

Contact inserts	
Number of poles	36
Rated current (DIN EN 61984)	10 A
Rated voltage (DIN EN 61984)	250 V
Rated impulse voltage (DIN EN 61984)	4 kV
Pollution severity	3
Rated voltage according to UL/CSA	600 V
Insulation strength	10 ¹² Ω
Surge voltage category	III
Limit temperature	-40 °C ... 125 °C
UL 94 flammability rating	V-0
Plugging cycles	≥ 500
Material	Polycarbonate, glass fibre reinforced
Required plug-in slots	2

Note

**HDC-MHD 36-modules in the IP65-housing,
Conductor H05V-K0.5:**

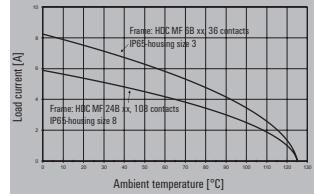

**HDC-MHD 36-modules in the IP65-housing,
Conductor H07V-K2.5:**

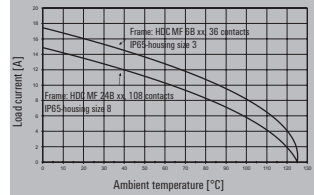

Crimp connection



Version	Type	Order No.
Male	HDC MHD 36 MC	1428860000
Female	HDC MHD 36 FC	1428870000

Note

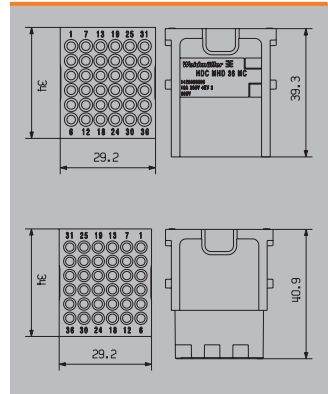

Accessories

Crimping contact

Surface finish gold



Surface finish silver



Male			Female		
Qty.	Type	Order No.	Type	Order No.	Order No.
100	HDC-C-HD-SM0.14-0.37AU	1651620000	HDC-C-HD-BM0.14-0.37AU	1651670000	1651670000
100	HDC-C-HD-SM0.5AU	1651630000	HDC-C-HD-BM0.5AU	1651680000	1651680000
100	HDC-C-HD-SM0.75-1.00AU	1651640000	HDC-C-HD-BM0.75-1.00AU	1651690000	1651690000
100	HDC-C-HD-SM1.5AU	1651650000	HDC-C-HD-BM1.5AU	1651700000	1651700000
100	HDC-C-HD-SM2.5AU	1651660000	HDC-C-HD-BM2.5AU	1651710000	1651710000
100	HDC-C-HD-SM0.14-0.37AG	1651520000	HDC-C-HD-BM0.14-0.37AG	1651570000	1651570000
100	HDC-C-HD-SM0.5AG	1651530000	HDC-C-HD-BM0.5AG	1651580000	1651580000
100	HDC-C-HD-SM0.75-1.00AG	1601750000	HDC-C-HD-BM0.75-1.00AG	1601760000	1601760000
100	HDC-C-HD-SM1.5AG	1651550000	HDC-C-HD-BM1.5AG	1651600000	1651600000
100	HDC-C-HD-SM2.5AG	1651560000	HDC-C-HD-BM2.5AG	1651610000	1651610000

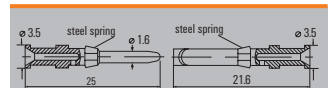

Conductor cross-section	Insulation stripping length
0.14 - 0.37 mm ²	AWG 26-22 8 mm
0.50 mm ²	AWG 20 8 mm
0.75 - 1.00 mm ²	AWG 18 8 mm
1.50 mm ²	AWG 16 8 mm
2.50 mm ²	AWG 14 6 mm

Tools



Contact Removal Tool	
REMOVAL TOOL HD	1866730000
Pressing tool	
CTX CM 1.6/2.5	9018490000
CTIN CM 1.6/2.5	9205430000
Note	Overview of the crimp inserts in the chapter RockStar® Accessories, tools and cable entries.

ModuPlug®
HDC MHD 17
Crimp connection

Technical data

Contact inserts	
Number of poles	17
Rated current (DIN EN 61984)	10 A
Rated voltage (DIN EN 61984)	160 V
Rated impulse voltage (DIN EN 61984)	2.5 kV
Pollution severity	3
Rated voltage according to UL/CSA	160 V
Conductor cross-section	0.14...2.5 mm ²
Surge voltage category	III
Limit temperature	-40 °C ... 125 °C
UL 94 flammability rating	V-0
Plugging cycles	≥ 500
Material	Polycarbonate
Required plug-in slots	1

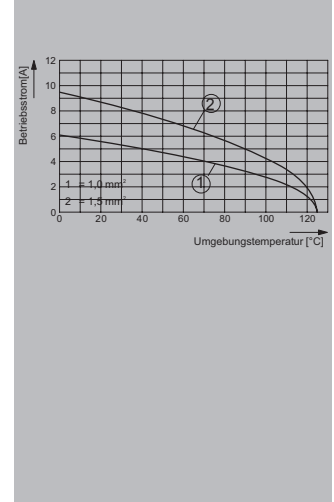

Note

Crimp connection



Version	Type	Order No.
Male	HDC MHD 17 MC	2748480000
Female	HDC MHD 17 FC	2748490000

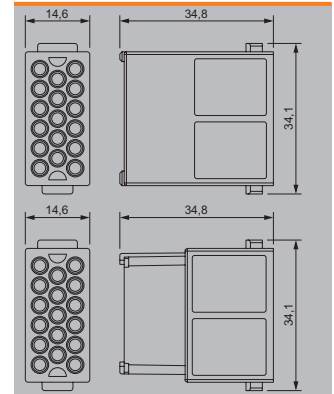

Note

Accessories

Crimping contact

Surface finish gold



Surface finish silver



Male			Female		
Qty.	Type	Order No.	Type	Order No.	Order No.
100	HDC-C-HD-SM0.14-0.37AU	1651620000	HDC-C-HD-BM0.14-0.37AU	1651670000	1651670000
100	HDC-C-HD-SM0.5AU	1651630000	HDC-C-HD-BM0.5AU	1651680000	1651680000
100	HDC-C-HD-SM0.75-1.00AU	1651640000	HDC-C-HD-BM0.75-1.00AU	1651690000	1651690000
100	HDC-C-HD-SM1.5AU	1651650000	HDC-C-HD-BM1.5AU	1651700000	1651700000
100	HDC-C-HD-SM2.5AU	1651660000	HDC-C-HD-BM2.5AU	1651710000	1651710000
100	HDC-C-HD-SM0.14-0.37AG	1651520000	HDC-C-HD-BM0.14-0.37AG	1651570000	1651570000
100	HDC-C-HD-SM0.5AG	1651530000	HDC-C-HD-BM0.5AG	1651580000	1651580000
100	HDC-C-HD-SM0.75-1.00AG	1601750000	HDC-C-HD-BM0.75-1.00AG	1601760000	1601760000
100	HDC-C-HD-SM1.5AG	1651550000	HDC-C-HD-BM1.5AG	1651600000	1651600000
100	HDC-C-HD-SM2.5AG	1651560000	HDC-C-HD-BM2.5AG	1651610000	1651610000

Conductor cross-section	Insulation stripping length
0.14 - 0.37 mm ²	AWG 26-22 8 mm
0.50 mm ²	AWG 20 8 mm
0.75 - 1.00 mm ²	AWG 18 8 mm
1.50 mm ²	AWG 16 8 mm
2.50 mm ²	AWG 14 6 mm

Tools



Contact Removal Tool	
REMOVAL TOOL HD	1866730000
Pressing tool	
CTX CM 1.6/2.5	9018490000
CTIN CM 1.6/2.5	9205430000
Note	Overview of the crimp inserts in the chapter RockStar® Accessories, tools and cable entries.

RockStar® ModuPlug modules

ModuPlug®
HDC MHD 12
Crimp connection

Technical data

Contact inserts	
Number of poles	12
Rated current (DIN EN 61984)	10 A
Rated voltage (DIN EN 61984)	250 V
Rated impulse voltage (DIN EN 61984)	4 kV
Pollution severity	3
Rated voltage according to UL/CSA	600 V
Insulation strength	10 ¹² Ω
Surge voltage category	III
Limit temperature	-40 °C ... 125 °C
UL 94 flammability rating	V-0
Plugging cycles	≥ 500
Material	Polycarbonate, glass fibre reinforced
Required plug-in slots	1

Note

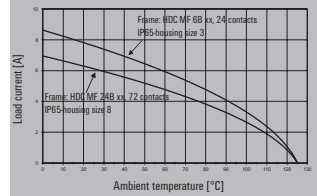
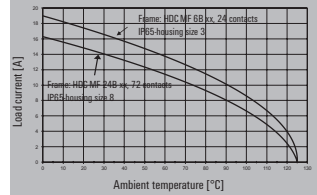
HDC-MHD 12-modules in the IP65-housing,
Conductor H05V-K0.5:HDC-MHD 12-modules in the IP65-housing,
Conductor H07V-K2.5:

Crimp connection



Version	Type	Order No.
Male	HDC MHD 12 MC	1428840000
Female	HDC MHD 12 FC	1428850000

Note

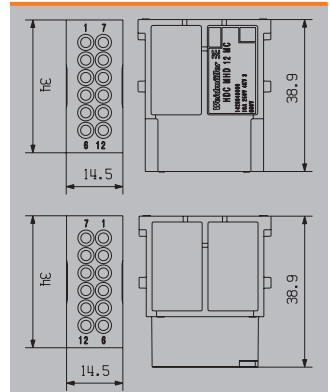

Accessories

Crimping contact

Surface finish gold



Surface finish silver



Male			Female		
Qty.	Type	Order No.	Type	Order No.	Order No.
100	HDC-C-HD-SM0.14-0.37AU	1651620000	HDC-C-HD-BM0.14-0.37AU	1651670000	1651670000
100	HDC-C-HD-SM0.5AU	1651630000	HDC-C-HD-BM0.5AU	1651680000	1651680000
100	HDC-C-HD-SM0.75-1.00AU	1651640000	HDC-C-HD-BM0.75-1.00AU	1651690000	1651690000
100	HDC-C-HD-SM1.5AG	1651650000	HDC-C-HD-BM1.5AG	1651700000	1651700000
100	HDC-C-HD-SM2.5AG	1651660000	HDC-C-HD-BM2.5AG	1651710000	1651710000
100	HDC-C-HD-SM0.14-0.37AG	1651520000	HDC-C-HD-BM0.14-0.37AG	1651570000	1651570000
100	HDC-C-HD-SM0.5AG	1651530000	HDC-C-HD-BM0.5AG	1651580000	1651580000
100	HDC-C-HD-SM0.75-1.00AG	1601750000	HDC-C-HD-BM0.75-1.00AG	1601760000	1601760000
100	HDC-C-HD-SM1.5AG	1651550000	HDC-C-HD-BM1.5AG	1651600000	1651600000
100	HDC-C-HD-SM2.5AG	1651560000	HDC-C-HD-BM2.5AG	1651610000	1651610000

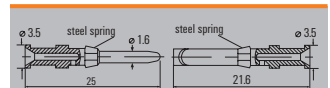

Conductor cross-section	Insulation stripping length
0.14 - 0.37 mm ²	AWG 26-22 8 mm
0.50 mm ²	AWG 20 8 mm
0.75 - 1.00 mm ²	AWG 18 8 mm
1.50 mm ²	AWG 16 8 mm
2.50 mm ²	AWG 14 6 mm

Tools



Contact Removal Tool	
REMOVAL TOOL HD	1866730000
Pressing tool	
CTX CM 1.6/2.5	9018490000
CTIN CM 1.6/2.5	9205430000
Note	Overview of the crimp inserts in the chapter RockStar® Accessories, tools and cable entries.

ModuPlug®
HDC MHD 12
PUSH IN connection

Technical data

Contact inserts

Number of poles	12
Rated current (DIN EN 61984)	10 A
Rated voltage (DIN EN 61984)	250 V
Rated impulse voltage (DIN EN 61984)	4 kV
Pollution severity	3
Rated voltage according to UL/CSA	600 V
Conductor cross-section	0.14...1.5 mm ²
Surge voltage category	III
Limit temperature	-40 °C ... 125 °C
UL 94 flammability rating	V-0
Plugging cycles	≥ 500
Material	Polycarbonate
Required plug-in slots	1

Note

PUSH IN with actuator



Version	Type	Order No.
Male	HDC MHD 12 MP	2748460000
Female	HDC MHD 12 FP	2748470000

Note

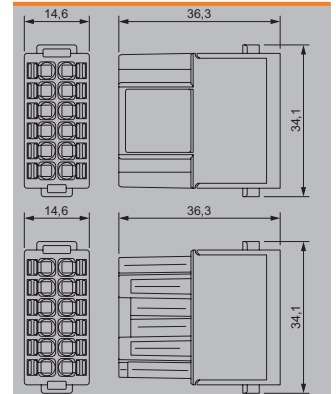

RockStar® ModuPlug modules

ModuPlug®
HDC MGBIT 8
Crimp connection
Technical data

Contact inserts	
Number of poles	8
Rated current (DIN EN 61984)	5 A
Rated voltage (DIN EN 61984)	50 V
Rated impulse voltage (DIN EN 61984)	0.8 kV
Pollution severity	3
Rated voltage according to UL/CSA	50 V
Conductor cross-section	0.08...0.5 mm ²
Category	Cat. 6A
Limit temperature	-40 °C ... 125 °C
UL 94 flammability rating	V-0
Plugging cycles	≥ 500
Material	Polycarbonate
Required plug-in slots	1

Note

Crimp connection



Version	Type	Order No.
Male	HDC MGBIT 8 MC	2748520000
Female	HDC MGBIT 8 FC	2748530000

Note

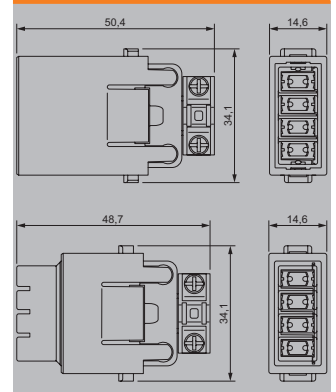
Accessories

Crimping contact

Surface finish gold



Male			Female		
Qty.	Type	Order No.	Type	Order No.	Order No.
100	HDC C HS SMO.08-0.12 AU	2748710000	HDC C HS BMO.08-0.12 AU	2748730000	
100	HDC C HS SMO.2-0.5 AU	2748700000	HDC C HS BMO.2-0.5 AU	2748720000	

ModuPlug® HDC MEMC 2 Module

Technical data

Contact inserts	
Number of poles	2
Conductor cross-section	0.14...2.5 mm ²
Limit temperature	-40 °C ... 125 °C
UL 94 flammability rating	V-0
Plugging cycles	≥ 500
Material	Polycarbonate
Required plug-in slots	2

Note

Crimp connection



Version	Type	Order No.
Male	HDC MEMC 2 MC	2748560000
Female	HDC MEMC 2 FC	2748570000

Note

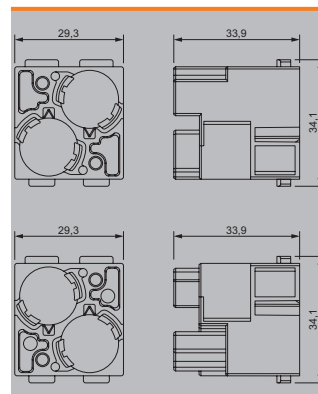

RockStar® ModuPlug modules

ModuPlug®
HDC MEMC 2
Data inserts

Technical data

Contact inserts	
Rated current (DIN EN 61984)	HDC MBUS HD 1: 10 A HDC MBUS HE 1: 16 A HDC MBUS HD 4: 10 A HDC MBUS HS 8: 5 A
Rated voltage (DIN EN 61984)	HDC MBUS HD 1: 50 V HDC MBUS HE 1: 50 V HDC MBUS HD 4: 50 V HDC MBUS HS 8: 50 V
Pollution severity	3
Conductor cross-section	0.14...2.5 mm ²
Limit temperature	-40 °C ... 125 °C
UL 94 flammability rating	V-0
Plugging cycles	≥ 500

Note

Crimp connection



Version	Type	Order No.
Male	HDC MBUS HD 1 M	2748630000
Male	HDC MBUS HE 1 M	2748610000
Male	HDC MBUS HD 4 M	2748590000
Male	HDC MBUS HS 8 M	2748650000
Female	HDC MBUS HD 1 F	2748620000
Female	HDC MBUS HE 1 F	2748600000
Female	HDC MBUS HD 4 F	2748580000
Female	HDC MBUS HS 8 F	2748640000

Note

Accessories

Crimping contact

Surface finish gold



Male			Female		
Qty.	Type	Order No.	Type	Order No.	Order No.
100	HDC-C-HD-SM0.14-0.37AU	1651620000	HDC-C-HD-BM0.14-0.37AU	1651670000	1651670000
100	HDC-C-HD-SM0.5AU	1651630000	HDC-C-HD-BM0.5AU	1651680000	1651680000
100	HDC-C-HD-SM0.75-1.00AU	1651640000	HDC-C-HD-BM0.75-1.00AU	1651690000	1651690000
100	HDC-C-HD-SM1.5AU	1651650000	HDC-C-HD-BM1.5AU	1651700000	1651700000
100	HDC-C-HD-SM2.5AU	1651660000	HDC-C-HD-BM2.5AU	1651710000	1651710000
100	HDC-C-HE-SM0.5AU	1651420000	HDC-C-HE-BM0.5AU	1651470000	1651470000
100	HDC-C-HE-SM0.75-1.00AU	1651430000	HDC-C-HE-BM0.75-1.00AU	1651480000	1651480000
100	HDC-C-HE-SM1.5AU	1651440000	HDC-C-HE-BM1.5AU	1651490000	1651490000
100	HDC-C-HE-SM2.5AU	1651450000	HDC-C-HE-BM2.5AU	1651500000	1651500000
100	HDC-C-HE-SM4.0AU	1651460000	HDC-C-HE-BM4.0AU	1651510000	1651510000
100	HDC-C-HE-SM4.65AU	1116540000	HDC-C-HE-BM4.65AU	1116530000	1116530000
100	HDC C HS SM0.08-0.12 AU	2748710000	HDC C HS BM0.08-0.12 AU	2748730000	2748730000
100	HDC C HS SM0.2-0.5 AU	2748700000	HDC C HS BM0.2-0.5 AU	2748720000	2748720000

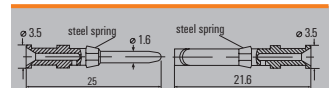

Conductor cross-section	Insulation stripping length	
0.14 - 0.37 mm ²	AWG 26-22	8 mm
0.50 mm ²	AWG 20	8 mm
0.75 - 1.00 mm ²	AWG 18	8 mm
1.50 mm ²	AWG 16	8 mm
2.50 mm ²	AWG 14	6 mm

ModuPlug®
HDC MCOAX 4
 Crimp connection, Solder connection

Technical data

Contact inserts	
Number of poles	4
Rated current (DIN EN 61984)	1.5 A
Rated voltage (DIN EN 61984)	48 V
Rated impulse voltage (DIN EN 61984)	0.8 kV
Pollution severity	3
Insulation strength	≥10 GΩ
Surge voltage category	III
Limit temperature	-40 °C ... 125 °C
UL 94 flammability rating	V-0
Plugging cycles	≥ 500
Material	Polycarbonate
Required plug-in slots	1

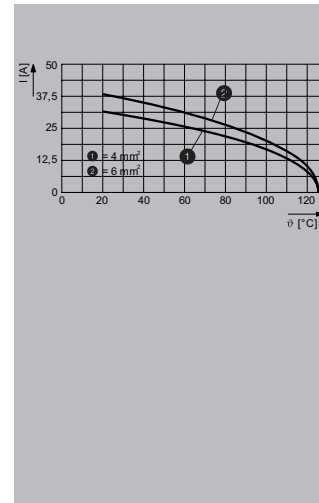

Note

Crimp connection, Solder connection



Version	Type	Order No.
Male	HDC MCOAX 4 MC	2748540000
Female	HDC MCOAX 4 FC	2748550000

Note

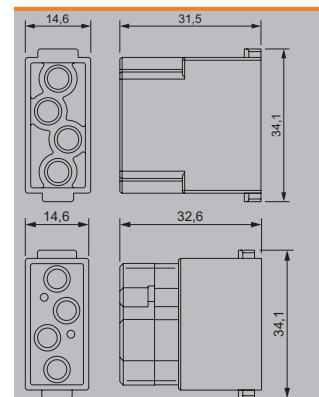

Accessories

Crimping contact

Surface finish gold



Male			Female		
Qty.	Type	Order No.	Type	Order No.	Order No.
10	HDC C COAX 50 M	2748670000	HDC C COAX 50 F	2748660000	2748660000
10	HDC C COAX 75 M	2748690000	HDC C COAX 75 F	2748680000	2748680000

Pressing tool



HTX 188	9011990000
HTG 174	9012410000

Note HTX 188 for COAX 75
 HTG 174 for COAX 50

RockStar® ModuPlug modules

ModuPlug®
HDC MBUS 2
Crimp connection
Technical data

Contact inserts	
Number of poles	2
Rated current (DIN EN 61984)	
Rated voltage (DIN EN 61984)	
Rated impulse voltage (DIN EN 61984)	
Pollution severity	3
Rated voltage according to UL/CSA	
Insulation strength	10 ¹² Ω
Surge voltage category	III
Limit temperature	-40 °C ... 125 °C
UL 94 flammability rating	V-0
Plugging cycles	≥ 500
Material	Polycarbonate, glass fibre reinforced
Required plug-in slots	1

Note

Crimp connection



Version	Type	Order No.
Male	HDC MBUS 2 MC	1428990000
Female	HDC MBUS 2 FC	1429020000

Note

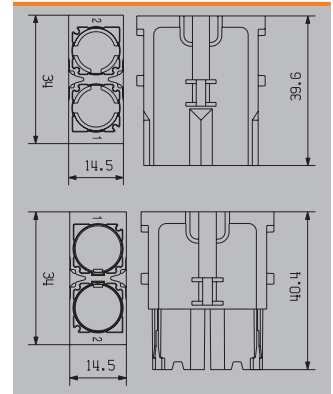
Fixing clip



Fixing clip	
HDC MBUS 2 MCLIP	1989290000
HDC MBUS 2 PCLIP	1989300000

Note MCLIP = metal version; PCLIP = plastic version

**ModuPlug®
HDC MDU**

Technical data

Contact inserts	
Number of poles	0
Rated current (DIN EN 61984)	
Rated voltage (DIN EN 61984)	
Rated impulse voltage (DIN EN 61984)	
Pollution severity	3
Rated voltage according to UL/CSA	
Insulation strength	
Surge voltage category	
Limit temperature	-40 °C ... 125 °C
UL 94 flammability rating	V-0
Plugging cycles	≥ 500
Material	Polycarbonate, glass fibre reinforced
Required plug-in slots	0.5

Note

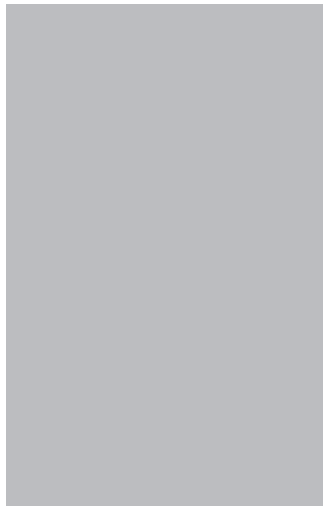

Version	Type	Order No.
other	HDC MDU	1429040000

Note

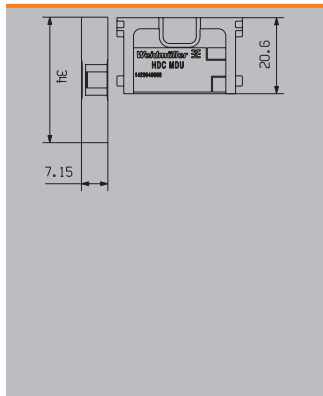

RockStar® ModuPlug Field attachable data connector

Cat. 5, D-Type

Technical data

Contact inserts	
Number of poles	4
Rated current	4 A
Rated voltage	250 V
Category	Cat. 5e
Pollution severity	2
Transmission rate	100 MBit/s
Insulation strength	≥ 100 MΩ
Coding	D
Limit temperature	-40 °C ... 90 °C
Plugging cycles	100

Note



Version	Type	Qty.	Order No.
Male	HDC MBUS4 D5E MC	2	2427920000
Female	HDC MBUS4 D5E FC	2	2427930000

Note

Accessories

Crimping contact

Surface finish gold

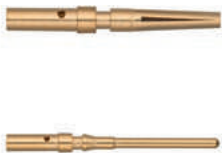

Male			Female		
Qty.	Type	Order No.	Type	Order No.	Order No.
100	HDC MBUS4 M AWG18	2565920000	HDC MBUS4 F AWG18	2565930000	2565930000
100	HDC MBUS4 M AWG22-20	2565900000	HDC MBUS4 F AWG22-20	2565910000	2565910000
100	HDC MBUS4 M AWG26-24	2565880000	HDC MBUS4 F AWG26-24	2565890000	2565890000

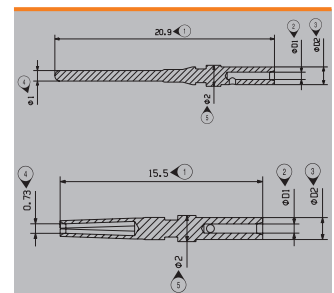

Cat. 6, X-Type

Technical data

Contact inserts	
Number of poles	8
Rated current	0.5 A
Rated voltage	50 V
Category	Cat. 6A
Pollution severity	2
Transmission rate	10 Gbps
Insulation strength	≥ 100 MΩ
Coding	X
Limit temperature	-40 °C ... 90 °C
Plugging cycles	100

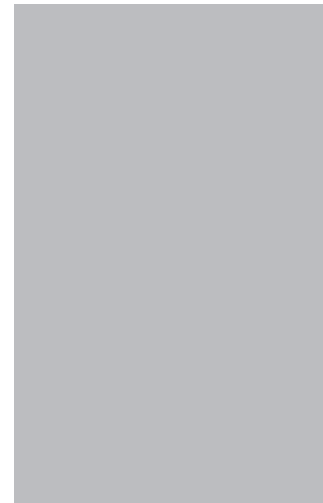

Note



Version	Type	Qty.	Order No.
Pin	HDC MBUS8 X6A MC	2	2427900000
Female	HDC MBUS8 X6A FC	2	2427910000

Note

Accessories

Crimping contact

Surface finish gold



Male			Female		
Qty.	Type	Order No.	Type	Order No.	Order No.
100	HDC MBUS8 M AWG20	2565980000	HDC MBUS8 F AWG20	2565990000	2565990000
100	HDC MBUS8 M AWG22	2565960000	HDC MBUS8 F AWG22	2565970000	2565970000
100	HDC MBUS8 M AWG26-24	2565940000	HDC MBUS8 F AWG26-24	2565950000	2565950000

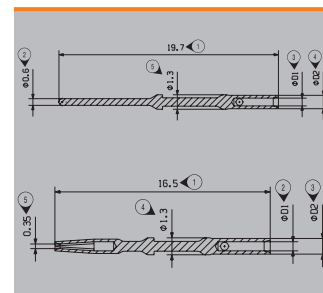

RockStar® ModuPlug Field attachable data connector

Accessories

Shielding sleeve



Outer cable diameter	Type	Order No.
3...5mm	HDC MBUS CFS 5.0	2566080000
5...7mm	HDC MBUS CFS 7.0	2566070000
6.8...7.3mm	HDC MBUS CF 7.3	2566060000
7.4...7.9mm	HDC MBUS CF 7.9	2566050000
8...8.5mm	HDC MBUS CF 8.5	2566040000
8.6...9.1mm	HDC MBUS CF 9.1	2566030000
9.2...9.7mm	HDC MBUS CF 9.7	2566020000
9.8...10.3mm	HDC MBUS CF 10.3	2566010000
10.4...11mm	HDC MBUS CF 11.0	2566000000

Note

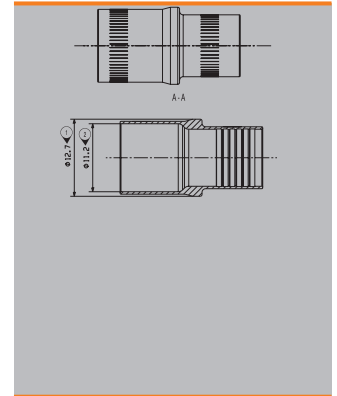

Inserts and crimping tools for shielding sleeve



Product type	Type	Order No.
Pressing tool	HDC MBUS CT A 9.2-10.3	2592690000
Pressing tool	HDC MBUS CT B 8.0-9.1	2592710000
Pressing tool	HDC MBUS CT C 6.8-7.9	2592730000
Crimping tool insert	HDC MBUS CI A 9.2-10.3	2592700000
Crimping tool insert	HDC MBUS CI B 8.0-9.1	2592720000
Crimping tool insert	HDC MBUS CI C 6.8-7.9	2592740000

Note

Crimping tool



Product type	Type	Order No.
Locator for crimping tool	HDC MBUS CL X/D 0.6/1.0	2592680000
Crimping tool for contacts	HDC MBUS CT X/D 0.6/1.0	2592650000

Note

RockStar® ModuPlug Field attachable data connector

Cat. 5e raw cable

Technical data

Number of poles	4
Category	Cat. 5e
Rated current	4 A
Rated voltage	250 V
Pollution severity	2
Operating temperature	-30...90 °C
Note	

C

Industrial cable



Module side version	Cable length	Opposite side version	Type	Order No.
open	100 m	open	HDC XX5E01 00XXXDM-1000	2712571000

Note

Railway cable



Module side version	Cable length	Opposite side version	Type	Order No.
open	100 m	open	HDC XX5E02 00XXXDM-1000	2712581000

Note

Cat. 6_A raw cable

Technical data

Number of poles	8
Category	Cat.7 (ISO/IEC 11801)
Rated current	0.5 A
Rated voltage	100 V
Pollution severity	2
Insulation strength	≥ 500 MΩ
Operating temperature	-40...80 °C
Note	

Industrial cable



Module side version	Cable length	Opposite side version	Type	Order No.
open	100 m	open	HDC XX6A02 00XXXDM-1000	2712681000

Note

Railway cable



Module side version	Cable length	Opposite side version	Type	Order No.
open	100 m	open	HDC XX6A01 00XXXDM-1000	2712671000

Note

RockStar® ModuPlug data inserts

Cat. 5e Industrial cable



Multiple cable glands for data lines in chapter J.

Technical data

Number of poles	4
Transmission rate	100 MBit/s
Category	Cat. 5e
Coding	D
Rated current	4 A
Rated voltage	250 V
Pollution severity	2
Insulation strength	≥ 10 ³ Ω
Limit temperature	-30 °C ... 90 °C
Plugging cycles	≥ 100
Contact surface	Au (Gold)
Note	Round plug-in connector in accordance with IEC 61076-2-101

Female / Female



Module side version	Cable length	Opposite side version	Type	Order No.
Female	0.5 m	Female	HDC XX5E01 FFSXXX-0050	2652760050
Female	1 m	Female	HDC XX5E01 FFSXXX-0100	2652760100
Female	1.5 m	Female	HDC XX5E01 FFSXXX-0150	2652760150
Female	3 m	Female	HDC XX5E01 FFSXXX-0300	2652760300
Female	5 m	Female	HDC XX5E01 FFSXXX-0500	2652760500
Note	Other versions and cable lengths on request			

Female / Female M12



Module side version	Cable length	Opposite side version	Type	Order No.
Female	0.5 m	Female, M12D	HDC XX5E01 FFSM12D-0050	2503540050
Female	1 m	Female, M12D	HDC XX5E01 FFSM12D-0100	2503540100
Female	1.5 m	Female, M12D	HDC XX5E01 FFSM12D-0150	2503540150
Female	3 m	Female, M12D	HDC XX5E01 FFSM12D-0300	2503540300
Female	5 m	Female, M12D	HDC XX5E01 FFSM12D-0500	2503540500
Note	Other versions and cable lengths on request			

Female / Male M12



Module side version	Cable length	Opposite side version	Type	Order No.
Female	0.5 m	Male, straight, M12D	HDC XX5E01 FMSM12D-0050	2451120050
Female	1 m	Male, straight, M12D	HDC XX5E01 FMSM12D-0100	2451120100
Female	1.5 m	Male, straight, M12D	HDC XX5E01 FMSM12D-0150	2451120150
Female	3 m	Male, straight, M12D	HDC XX5E01 FMSM12D-0300	2451120300
Female	5 m	Male, straight, M12D	HDC XX5E01 FMSM12D-0500	2451120500
Note	Other versions and cable lengths on request			

Female / Male RJ45



Module side version	Cable length	Opposite side version	Type	Order No.
Female	0.5 m	Male, straight, RJ45	HDC XX5E01 FMSRJ45-0050	2451080050
Female	1 m	Male, straight, RJ45	HDC XX5E01 FMSRJ45-0100	2451080100
Female	1.5 m	Male, straight, RJ45	HDC XX5E01 FMSRJ45-0150	2451080150
Female	3 m	Male, straight, RJ45	HDC XX5E01 FMSRJ45-0300	2451080300
Female	5 m	Male, straight, RJ45	HDC XX5E01 FMSRJ45-0500	2451080500
Note	Other versions and cable lengths on request			

Female / open end



Module side version	Cable length	Opposite side version	Type	Order No.
Female	0.5 m	open	HDC XX5E01 FOXXXXX-0050	2003920050
Female	1 m	open	HDC XX5E01 FOXXXXX-0100	2003920100
Female	1.5 m	open	HDC XX5E01 FOXXXXX-0150	2003920150
Female	3 m	open	HDC XX5E01 FOXXXXX-0300	2003920300
Female	5 m	open	HDC XX5E01 FOXXXXX-0500	2003920500
Note Other versions and cable lengths on request				

Male / Female



Module side version	Cable length	Opposite side version	Type	Order No.
Male	0.5 m	Female, straight	HDC XX5E01 MFSXXX-0050	2453550050
Male	1 m	Female, straight	HDC XX5E01 MFSXXX-0100	2453550100
Male	1.5 m	Female, straight	HDC XX5E01 MFSXXX-0150	2453550150
Male	3 m	Female, straight	HDC XX5E01 MFSXXX-0300	2453550300
Male	5 m	Female, straight	HDC XX5E01 MFSXXX-0500	2453550500
Note Other versions and cable lengths on request				

Male / Female M12



Module side version	Cable length	Opposite side version	Type	Order No.
Male	0.5 m	Female, straight, M12D	HDC XX5E01 MFMS12D-0050	2450450050
Male	1 m	Female, straight, M12D	HDC XX5E01 MFMS12D-0100	2450450100
Male	1.5 m	Female, straight, M12D	HDC XX5E01 MFMS12D-0150	2450450150
Male	3 m	Female, straight, M12D	HDC XX5E01 MFMS12D-0300	2450450300
Male	5 m	Female, straight, M12D	HDC XX5E01 MFMS12D-0500	2450450500
Note Other versions and cable lengths on request				

Male / Male M12



Module side version	Cable length	Opposite side version	Type	Order No.
Male	0.5 m	Male, straight, M12D	HDC XX5E01 MMSM12D-0050	2451110050
Male	1 m	Male, straight, M12D	HDC XX5E01 MMSM12D-0100	2451110100
Male	1.5 m	Male, straight, M12D	HDC XX5E01 MMSM12D-0150	2451110150
Male	3 m	Male, straight, M12D	HDC XX5E01 MMSM12D-0300	2451110300
Male	5 m	Male, straight, M12D	HDC XX5E01 MMSM12D-0500	2451110500
Note Other versions and cable lengths on request				

Male / Male RJ45



Module side version	Cable length	Opposite side version	Type	Order No.
Male	0.5 m	Male, straight, RJ45	HDC XX5E01 MMSRJ45-0050	2450490050
Male	1 m	Male, straight, RJ45	HDC XX5E01 MMSRJ45-0100	2450490100
Male	1.5 m	Male, straight, RJ45	HDC XX5E01 MMSRJ45-0150	2450490150
Male	3 m	Male, straight, RJ45	HDC XX5E01 MMSRJ45-0300	2450490300
Male	5 m	Male, straight, RJ45	HDC XX5E01 MMSRJ45-0500	2450490500
Note Other versions and cable lengths on request				

Male / open end



Module side version	Cable length	Opposite side version	Type	Order No.
Male	0.5 m	open	HDC XX5E01 MOXXXXX-0050	2003890050
Male	1 m	open	HDC XX5E01 MOXXXXX-0100	2003890100
Male	1.5 m	open	HDC XX5E01 MOXXXXX-0150	2003890150
Male	3 m	open	HDC XX5E01 MOXXXXX-0300	2003890300
Male	5 m	open	HDC XX5E01 MOXXXXX-0500	2003890500
Note Other versions and cable lengths on request				

Cat. 5e railway cable



Multiple cable glands for data lines in chapter J.

Technical data

Number of poles	4
Transmission rate	100 MBit/s
Category	Cat. 5e
Coding	D
Rated current	4 A
Rated voltage	250 V
Pollution severity	2
Insulation strength	≥ 10 ⁹ Ω
Limit temperature	-40 °C ... 90 °C
Plugging cycles	≤ 100
Contact surface	Au (Gold)
Note	Round plug-in connector in accordance with IEC 61076-2-101

Female / Female M12



Module side version	Cable length	Opposite side version	Type	Order No.
Female	0.5 m	Female, straight, M12D	HDC XX5E02 FFSM12D-0050	2503810050
Female	1 m	Female, straight, M12D	HDC XX5E02 FFSM12D-0100	2503810100
Female	1.5 m	Female, straight, M12D	HDC XX5E02 FFSM12D-0150	2503810150
Female	3 m	Female, straight, M12D	HDC XX5E02 FFSM12D-0300	2503810300
Female	5 m	Female, straight, M12D	HDC XX5E02 FFSM12D-0500	2503810500
Note	Other versions and cable lengths on request			

Female / Male M12



Module side version	Cable length	Opposite side version	Type	Order No.
Female	0.5 m	Male, straight, M12D	HDC XX5E02 FMSM12D-0050	2503760050
Female	1 m	Male, straight, M12D	HDC XX5E02 FMSM12D-0100	2503760100
Female	1.5 m	Male, straight, M12D	HDC XX5E02 FMSM12D-0150	2503760150
Female	3 m	Male, straight, M12D	HDC XX5E02 FMSM12D-0300	2503760300
Female	5 m	Male, straight, M12D	HDC XX5E02 FMSM12D-0500	2503760500
Note	Other versions and cable lengths on request			

Female / Male RJ45



Module side version	Cable length	Opposite side version	Type	Order No.
Female	0.5 m	Male, straight, RJ45	HDC XX5E02 FMSRJ45-0050	2503720050
Female	1 m	Male, straight, RJ45	HDC XX5E02 FMSRJ45-0100	2503720100
Female	1.5 m	Male, straight, RJ45	HDC XX5E02 FMSRJ45-0150	2503720150
Female	3 m	Male, straight, RJ45	HDC XX5E02 FMSRJ45-0300	2503720300
Female	5 m	Male, straight, RJ45	HDC XX5E02 FMSRJ45-0500	2503720500
Note	Other versions and cable lengths on request			

Female / open end



Module side version	Cable length	Opposite side version	Type	Order No.
Female	0.5 m	open	HDC XX5E02 FOXXXXX-0050	2003930050
Female	1 m	open	HDC XX5E02 FOXXXXX-0100	2003930100
Female	1.5 m	open	HDC XX5E02 FOXXXXX-0150	2003930150
Female	3 m	open	HDC XX5E02 FOXXXXX-0300	2003930300
Female	5 m	open	HDC XX5E02 FOXXXXX-0500	2003930500
Note	Other versions and cable lengths on request			

Male / Female



Module side version	Cable length	Opposite side version	Type	Order No.
Male	0.5 m	Female, straight	HDC XX5E02 MFSXXXX-0050	2503790050
Male	1 m	Female, straight	HDC XX5E02 MFSXXXX-0100	2503790100
Male	1.5 m	Female, straight	HDC XX5E02 MFSXXXX-0150	2503790150
Male	3 m	Female, straight	HDC XX5E02 MFSXXXX-0300	2503790300
Male	5 m	Female, straight	HDC XX5E02 MFSXXXX-0500	2503790500
Note Other versions and cable lengths on request				

Male / Female M12



Module side version	Cable length	Opposite side version	Type	Order No.
Male	0.5 m	Female, straight, M12D	HDC XX5E02 MFSM12D-0050	2503700050
Male	1 m	Female, straight, M12D	HDC XX5E02 MFSM12D-0100	2503700100
Male	1.5 m	Female, straight, M12D	HDC XX5E02 MFSM12D-0150	2503700150
Male	3 m	Female, straight, M12D	HDC XX5E02 MFSM12D-0300	2503700300
Male	5 m	Female, straight, M12D	HDC XX5E02 MFSM12D-0500	2503700500
Note Other versions and cable lengths on request				

Male / Male



Module side version	Cable length	Opposite side version	Type	Order No.
Male	0.5 m	Male, straight	HDC XX5E02 MMSXXXX-0050	2659960050
Male	1 m	Male, straight	HDC XX5E02 MMSXXXX-0100	2659960100
Male	1.5 m	Male, straight	HDC XX5E02 MMSXXXX-0150	2659960150
Male	3 m	Male, straight	HDC XX5E02 MMSXXXX-0300	2659960300
Male	5 m	Male, straight	HDC XX5E02 MMSXXXX-0500	2659960500
Note Other versions and cable lengths on request				

Male / Male M12



Module side version	Cable length	Opposite side version	Type	Order No.
Male	0.5 m	Male, straight, M12D	HDC XX5E02 MMSM12D-0050	2503750050
Male	1 m	Male, straight, M12D	HDC XX5E02 MMSM12D-0100	2503750100
Male	1.5 m	Male, straight, M12D	HDC XX5E02 MMSM12D-0150	2503750150
Male	3 m	Male, straight, M12D	HDC XX5E02 MMSM12D-0300	2503750300
Male	5 m	Male, straight, M12D	HDC XX5E02 MMSM12D-0500	2503750500
Note Other versions and cable lengths on request				

Male / Male RJ45



Module side version	Cable length	Opposite side version	Type	Order No.
Male	0.5 m	Male, straight, RJ45	HDC XX5E02 MMSRJ45-0050	2503710050
Male	1 m	Male, straight, RJ45	HDC XX5E02 MMSRJ45-0100	2503710100
Male	1.5 m	Male, straight, RJ45	HDC XX5E02 MMSRJ45-0150	2503710150
Male	3 m	Male, straight, RJ45	HDC XX5E02 MMSRJ45-0300	2503710300
Male	5 m	Male, straight, RJ45	HDC XX5E02 MMSRJ45-0500	2503710500
Note Other versions and cable lengths on request				

Male / open end



Module side version	Cable length	Opposite side version	Type	Order No.
Male	0.5 m	open	HDC XX5E02 MOXXXXX-0050	2003900050
Male	1 m	open	HDC XX5E02 MOXXXXX-0100	2003900100
Male	1.5 m	open	HDC XX5E02 MOXXXXX-0150	2003900150
Male	3 m	open	HDC XX5E02 MOXXXXX-0300	2003900300
Male	5 m	open	HDC XX5E02 MOXXXXX-0500	2003900500
Note Other versions and cable lengths on request				

Cat. 6_A Industrial cable

Multiple cable glands for data lines in chapter J.

Technical data

Number of poles	8
Transmission rate	10 GBit/s
Category	Cat. 6A
Coding	X
Rated current	0.5 A
Rated voltage	50 V
Pollution severity	2
Insulation strength	≥ 10 ³ Ω
Limit temperature	-30 °C ... 90 °C
Plugging cycles	≥ 100
Contact surface	Au (Gold)
Note	Round plug-in connector in accordance with IEC 61076-2-101

Female / Female



Module side version	Cable length	Opposite side version	Type	Order No.
Female	0.5 m	Female, straight	HDC XX6A02 FFSXXX-0050	2634700050
Female	1 m	Female, straight	HDC XX6A02 FFSXXX-0100	2634700100
Female	1.5 m	Female, straight	HDC XX6A02 FFSXXX-0150	2634700150
Female	3 m	Female, straight	HDC XX6A02 FFSXXX-0300	2634700300
Female	5 m	Female, straight	HDC XX6A02 FFSXXX-0500	2634700500
Note	Other versions and cable lengths on request			

Female / Female M12



Module side version	Cable length	Opposite side version	Type	Order No.
Female	0.5 m	Female, straight, M12X	HDC XX6A02 FFSM12X-0050	2503820050
Female	1 m	Female, straight, M12X	HDC XX6A02 FFSM12X-0100	2503820100
Female	1.5 m	Female, straight, M12X	HDC XX6A02 FFSM12X-0150	2503820150
Female	3 m	Female, straight, M12X	HDC XX6A02 FFSM12X-0300	2503820300
Female	5 m	Female, straight, M12X	HDC XX6A02 FFSM12X-0500	2503820500
Note	Other versions and cable lengths on request			

Female / Male M12



Module side version	Cable length	Opposite side version	Type	Order No.
Female	0.5 m	Male, straight, M12X	HDC XX6A02 FMSM12X-0050	2503780050
Female	1 m	Male, straight, M12X	HDC XX6A02 FMSM12X-0100	2503780100
Female	1.5 m	Male, straight, M12X	HDC XX6A02 FMSM12X-0150	2503780150
Female	3 m	Male, straight, M12X	HDC XX6A02 FMSM12X-0300	2503780300
Female	5 m	Male, straight, M12X	HDC XX6A02 FMSM12X-0500	2503780500
Note	Other versions and cable lengths on request			

Female / Male RJ45



Module side version	Cable length	Opposite side version	Type	Order No.
Female	0.5 m	Male, straight, RJ45	HDC XX6A02 FMSRJ45-0050	2503740050
Female	1 m	Male, straight, RJ45	HDC XX6A02 FMSRJ45-0100	2503740100
Female	1.5 m	Male, straight, RJ45	HDC XX6A02 FMSRJ45-0150	2503740150
Female	3 m	Male, straight, RJ45	HDC XX6A02 FMSRJ45-0300	2503740300
Female	5 m	Male, straight, RJ45	HDC XX6A02 FMSRJ45-0500	2503740500
Note	Other versions and cable lengths on request			

Female / open end



Module side version	Cable length	Opposite side version	Type	Order No.
Female	0.5 m	open	HDC XX6A02 FOXXXXX-0050	2003860050
Female	1 m	open	HDC XX6A02 FOXXXXX-0100	2003860100
Female	1.5 m	open	HDC XX6A02 FOXXXXX-0150	2003860150
Female	3 m	open	HDC XX6A02 FOXXXXX-0300	2003860300
Female	5 m	open	HDC XX6A02 FOXXXXX-0500	2003860500
Note Other versions and cable lengths on request				

Male / Female



Module side version	Cable length	Opposite side version	Type	Order No.
Male	0.5 m	Female, straight	HDC XX6A02 MFSXXXX-0050	2503800050
Male	1 m	Female, straight	HDC XX6A02 MFSXXXX-0100	2503800100
Male	1.5 m	Female, straight	HDC XX6A02 MFSXXXX-0150	2503800150
Male	3 m	Female, straight	HDC XX6A02 MFSXXXX-0300	2503800300
Male	5 m	Female, straight	HDC XX6A02 MFSXXXX-0500	2503800500
Note Other versions and cable lengths on request				

Male / Female M12



Module side version	Cable length	Opposite side version	Type	Order No.
Male	0.5 m	Female, straight, M12X	HDC XX6A02 MFSM12X-0050	2503690050
Male	1 m	Female, straight, M12X	HDC XX6A02 MFSM12X-0100	2503690100
Male	1.5 m	Female, straight, M12X	HDC XX6A02 MFSM12X-0150	2503690150
Male	3 m	Female, straight, M12X	HDC XX6A02 MFSM12X-0300	2503690300
Male	5 m	Female, straight, M12X	HDC XX6A02 MFSM12X-0500	2503690500
Note Other versions and cable lengths on request				

Male / Male M12



Module side version	Cable length	Opposite side version	Type	Order No.
Male	0.5 m	Male, straight, M12X	HDC XX6A02 MMSM12X-0050	2503770050
Male	1 m	Male, straight, M12X	HDC XX6A02 MMSM12X-0100	2503770100
Male	1.5 m	Male, straight, M12X	HDC XX6A02 MMSM12X-0150	2503770150
Male	3 m	Male, straight, M12X	HDC XX6A02 MMSM12X-0300	2503770300
Male	5 m	Male, straight, M12X	HDC XX6A02 MMSM12X-0500	2503770500
Note Other versions and cable lengths on request				

Male / Male RJ45



Module side version	Cable length	Opposite side version	Type	Order No.
Male	0.5 m	Male, straight, RJ45	HDC XX6A02 MMSRJ45-0050	2503730050
Male	1 m	Male, straight, RJ45	HDC XX6A02 MMSRJ45-0100	2503730100
Male	1.5 m	Male, straight, RJ45	HDC XX6A02 MMSRJ45-0150	2503730150
Male	3 m	Male, straight, RJ45	HDC XX6A02 MMSRJ45-0300	2503730300
Male	5 m	Male, straight, RJ45	HDC XX6A02 MMSRJ45-0500	2503730500
Note Other versions and cable lengths on request				

Male / open end



Module side version	Cable length	Opposite side version	Type	Order No.
Male	0.5 m	open	HDC XX6A02 MOXXXXX-0050	2003830050
Male	1 m	open	HDC XX6A02 MOXXXXX-0100	2003830100
Male	1.5 m	open	HDC XX6A02 MOXXXXX-0150	2003830150
Male	3 m	open	HDC XX6A02 MOXXXXX-0300	2003830300
Male	5 m	open	HDC XX6A02 MOXXXXX-0500	2003830500
Note Other versions and cable lengths on request				

RockStar® ModuPlug data inserts

Cat. 6_A railway cable

Multiple cable glands for data lines in chapter J.

Technical data

Number of poles	8
Transmission rate	10 GBit/s
Category	Cat. 6A
Coding	X
Rated current	0.5 A
Rated voltage	50 V
Pollution severity	2
Insulation strength	≥ 10 ⁹ Ω
Limit temperature	-40 °C ... 90 °C
Plugging cycles	100
Contact surface	Au (Gold)
Note	Round plug-in connector in accordance with IEC 61076-2-109

Female / Female M12



Module side version	Cable length	Opposite side version	Type	Order No.
Female	0.5 m	Female, straight, M12X	HDC XX6A01 FFSM12X-0050	2503550050
Female	1 m	Female, straight, M12X	HDC XX6A01 FFSM12X-0100	2503550100
Female	1.5 m	Female, straight, M12X	HDC XX6A01 FFSM12X-0150	2503550150
Female	3 m	Female, straight, M12X	HDC XX6A01 FFSM12X-0300	2503550300
Female	5 m	Female, straight, M12X	HDC XX6A01 FFSM12X-0500	2503550500
Note	Other versions and cable lengths on request			

Female / Male M12



Module side version	Cable length	Opposite side version	Type	Order No.
Female	0.5 m	Male, straight, M12X	HDC XX6A01 FMSM12X-0050	2451140050
Female	1 m	Male, straight, M12X	HDC XX6A01 FMSM12X-0100	2451140100
Female	1.5 m	Male, straight, M12X	HDC XX6A01 FMSM12X-0150	2451140150
Female	3 m	Male, straight, M12X	HDC XX6A01 FMSM12X-0300	2451140300
Female	5 m	Male, straight, M12X	HDC XX6A01 FMSM12X-0500	2451140500
Note	Other versions and cable lengths on request			

Female / Male RJ45



Module side version	Cable length	Opposite side version	Type	Order No.
Female	0.5 m	Male, straight, RJ45	HDC XX6A01 FMSRJ45-0050	2451100050
Female	1 m	Male, straight, RJ45	HDC XX6A01 FMSRJ45-0100	2451100100
Female	1.5 m	Male, straight, RJ45	HDC XX6A01 FMSRJ45-0150	2451100150
Female	3 m	Male, straight, RJ45	HDC XX6A01 FMSRJ45-0300	2451100300
Female	5 m	Male, straight, RJ45	HDC XX6A01 FMSRJ45-0500	2451100500
Note	Other versions and cable lengths on request			

Female / open end



Module side version	Cable length	Opposite side version	Type	Order No.
Female	0.5 m	open	HDC XX6A01 FOXXXXX-0050	2003850050
Female	1 m	open	HDC XX6A01 FOXXXXX-0100	2003850100
Female	1.5 m	open	HDC XX6A01 FOXXXXX-0150	2003850150
Female	3 m	open	HDC XX6A01 FOXXXXX-0300	2003850300
Female	5 m	open	HDC XX6A01 FOXXXXX-0500	2003850500
Note	Other versions and cable lengths on request			

Male / Female



Module side version	Cable length	Opposite side version	Type	Order No.
Male	0.5 m	Female, straight	HDC XX6A01 MFSXXXX-0050	2453540050
Male	1 m	Female, straight	HDC XX6A01 MFSXXXX-0100	2453540100
Male	1.5 m	Female, straight	HDC XX6A01 MFSXXXX-0150	2453540150
Male	3 m	Female, straight	HDC XX6A01 MFSXXXX-0300	2453540300
Male	5 m	Female, straight	HDC XX6A01 MFSXXXX-0500	2453540500
Note	Other versions and cable lengths on request			

Male / Female M12



Module side version	Cable length	Opposite side version	Type	Order No.
Male	0.5 m	Female, straight, M12X	HDC XX6A01 MFSM12X-0050	2450440050
Male	1 m	Female, straight, M12X	HDC XX6A01 MFSM12X-0100	2450440100
Male	1.5 m	Female, straight, M12X	HDC XX6A01 MFSM12X-0150	2450440150
Male	3 m	Female, straight, M12X	HDC XX6A01 MFSM12X-0300	2450440300
Male	5 m	Female, straight, M12X	HDC XX6A01 MFSM12X-0500	2450440500
Note	Other versions and cable lengths on request			

Male / Male M12



Module side version	Cable length	Opposite side version	Type	Order No.
Male	0.5 m	Male, straight, M12X	HDC XX6A01 MMSM12X-0050	2451130050
Male	1 m	Male, straight, M12X	HDC XX6A01 MMSM12X-0100	2451130100
Male	1.5 m	Male, straight, M12X	HDC XX6A01 MMSM12X-0150	2451130150
Male	3 m	Male, straight, M12X	HDC XX6A01 MMSM12X-0300	2451130300
Male	5 m	Male, straight, M12X	HDC XX6A01 MMSM12X-0500	2451130500
Note	Other versions and cable lengths on request			

Male / Male RJ45



Module side version	Cable length	Opposite side version	Type	Order No.
Male	0.5 m	Male, straight, RJ45	HDC XX6A01 MMSRJ45-0050	2451090050
Male	1 m	Male, straight, RJ45	HDC XX6A01 MMSRJ45-0100	2451090100
Male	1.5 m	Male, straight, RJ45	HDC XX6A01 MMSRJ45-0150	2451090150
Male	3 m	Male, straight, RJ45	HDC XX6A01 MMSRJ45-0300	2451090300
Male	5 m	Male, straight, RJ45	HDC XX6A01 MMSRJ45-0500	2451090500
Note	Other versions and cable lengths on request			

Male / open end



Module side version	Cable length	Opposite side version	Type	Order No.
Male	0.5 m	open	HDC XX6A01 MOXXXX-0050	2003820050
Male	1 m	open	HDC XX6A01 MOXXXX-0100	2003820100
Male	1.5 m	open	HDC XX6A01 MOXXXX-0150	2003820150
Male	3 m	open	HDC XX6A01 MOXXXX-0300	2003820300
Male	5 m	open	HDC XX6A01 MOXXXX-0500	2003820500
Note	Other versions and cable lengths on request			

Male / Male



Module side version	Cable length	Opposite side version	Type	Order No.
Male	0.5 m	Male	HDC XX6A01 MMSXXXX-0050	2659970050
Male	1 m	Male	HDC XX6A01 MMSXXXX-0100	2659970100
Male	1.5 m	Male	HDC XX6A01 MMSXXXX-0150	2659970150
Male	3 m	Male	HDC XX6A01 MMSXXXX-0300	2659970300
Male	5 m	Male	HDC XX6A01 MMSXXXX-0500	2659970500
Note	Other versions and cable lengths on request			

RockStar® ModuPlug data inserts

Cat. 6_A Industrial cable, suitable for drag chains

Multiple cable glands for data lines in chapter J.

Technical data

Number of poles	8
Transmission rate	10 GBit/s
Category	Cat. 6A
Coding	X
Rated current	0.5 A
Rated voltage	50 V
Pollution severity	2
Insulation strength	≥ 5 GΩ
Limit temperature	-30 °C ... 90 °C
Plugging cycles	≥ 100
Contact surface	Au (Gold)
Note	

Female / Male RJ45



Module side version	Cable length	Opposite side version	Type	Order No.
Female	3 m	Male	HDC XX6A03 FMSRJ45-0300	2546830300
Female	6 m	Male	HDC XX6A03 FMSRJ45-0600	2546830600

Note

Male / Female



Module side version	Cable length	Opposite side version	Type	Order No.
Male	30 m	Female	HDC XX6A03 MFSXXX-3000	25468113000

Note

Male / Male



Module side version	Cable length	Opposite side version	Type	Order No.
Male	30 m	Male	HDC XX6A03 MMSXXX-3000	2546843000
Male	50 m	Male	HDC XX6A03 MMSXXX-5000	2546845000

Note

MRJ45 modules

Technical data

Number of poles	8
Rated current (DIN EN 61984)	1 A
Rated voltage (DIN EN 61984)	50 V
Pollution severity	3
Insulation strength	10 ¹² Ω
Limit temperature	-40 °C ... 70 °C
Plugging cycles	750 (RJ45)
Surge voltage category	III
Note	

Crimp connection



Version	Type	Order No.
Plug insert, RJ45 crimp	HDC MRJ45 8PLUG MC	2592250000
Note Suitable pressing tool: 9202800000 TT 8 RS MP 8		

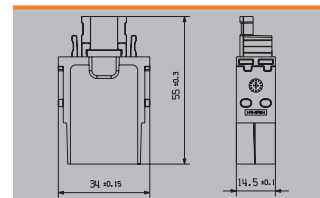

IDC terminal



Version	Type	Order No.
Plug insert, RJ45 tool-free, TIA-568A	HDC MRJ45 A MI	2592220000
Plug insert, RJ45 tool-free, TIA-568A, EIA/TIA T568 B, PROFINET	HDC MRJ45 ABP MI	2592210000
Plug insert, RJ45 tool-free, EIA/TIA T568 B	HDC MRJ45 B MI	2592230000
Plug insert, RJ45 tool-free, PROFINET	HDC MRJ45 P MI	2592240000
Note		

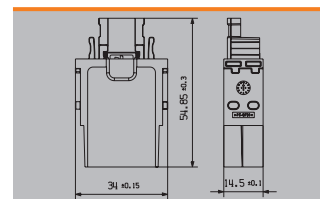

Version	Type	Order No.
Adapter module, RJ45 for patch cable	HDC MRJ45 PCADP MC	2592260000
Note		

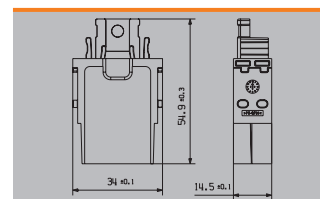

Version	Type	Order No.
RJ45 Gender Changer	HDC MRJ45 GC F	2592030000
Note		

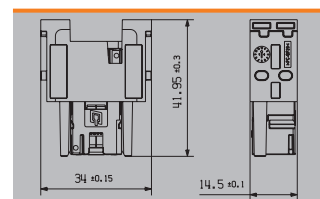

RockStar® ModuPlug RJ45 modules

MRJ45 patch cable

Technical data

Number of wires	8
Speed	10 GBit/s
Category	Cat. 6A
Operating voltage	48 V AC / DC
Sheath diameter, max.	5.9 mm
Cross-section	4*2*AWG 27/7 - 4*2*0.1 mm ²
Shielding	S/FTP
Material sheath	LSZH
Operating temperature	-20...60 °C
Contact surface	Au ≥ 0.8 µm
Note	



Cable length	Type	Order No.
0.2 m	HDC RJ4501 MMSCAT6-0020	2661950020
0.3 m	HDC RJ4501 MMSCAT6-0030	2661950030
0.4 m	HDC RJ4501 MMSCAT6-0040	2661950040
0.5 m	HDC RJ4501 MMSCAT6-0050	2661950050
0.6 m	HDC RJ4501 MMSCAT6-0060	2661950060
0.7 m	HDC RJ4501 MMSCAT6-0070	2661950070
0.8 m	HDC RJ4501 MMSCAT6-0080	2661950080
0.9 m	HDC RJ4501 MMSCAT6-0090	2661950090
1 m	HDC RJ4501 MMSCAT6-0100	2661950100
1.5 m	HDC RJ4501 MMSCAT6-0150	2661950150
2 m	HDC RJ4501 MMSCAT6-0200	2661950200
2.5 m	HDC RJ4501 MMSCAT6-0250	2661950250
3 m	HDC RJ4501 MMSCAT6-0300	2661950300
4 m	HDC RJ4501 MMSCAT6-0400	2661950400
5 m	HDC RJ4501 MMSCAT6-0500	2661950500
6 m	HDC RJ4501 MMSCAT6-0600	2661950600
7 m	HDC RJ4501 MMSCAT6-0700	2661950700
7.5 m	HDC RJ4501 MMSCAT6-0750	2661950750
8 m	HDC RJ4501 MMSCAT6-0800	2661950800
9 m	HDC RJ4501 MMSCAT6-0900	2661950900
10 m	HDC RJ4501 MMSCAT6-1000	2661951000
15 m	HDC RJ4501 MMSCAT6-1500	2661951500
20 m	HDC RJ4501 MMSCAT6-2000	2661952000
Note		



Adapter module	Order No.
HDC MRJ45 PCADP MC	2592260000
Note	

ModuPlug®
Pneumatic Modules

Technical data

Contact inserts	
Number of poles	2
Type of connection	Hose connection (pneumatic)
Module operating pressure	8 bar
Inner hose diameter, min.	6 mm
Inner hose diameter, max.	6 mm
Limit temperature	-40 °C ... 80 °C
UL 94 flammability rating	V-0
Plugging cycles	≥ 500
Material	Polycarbonate, glass fibre reinforced
Required plug-in slots	1

Note

Hose connection (pneumatic)



Deployment	Type	Order No.
Male, Female	HDC MPN 2	2637320000

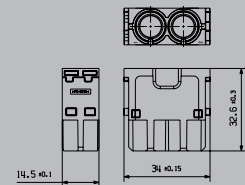

Note

Pneumatic contacts



Female	HDC MPN 6.0 F	2637390000
Male	HDC MPN 6.0 M	2637350000
Female with shut-off valve	HDC MPN 6.0 SOF	2637400000
Note		

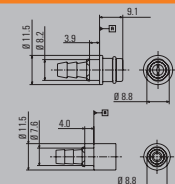

RockStar® ModuPlug pneumatic modules

**ModuPlug®
Pneumatic contacts**

Technical data

Contact inserts	
Number of poles	3
Type of connection	Hose connection (pneumatic)
Module operating pressure	8 bar
Inner hose diameter, min.	1.6 mm
Inner hose diameter, max.	4 mm
Limit temperature	-40 °C ... 80 °C
UL 94 flammability rating	V-0
Plugging cycles	≥ 500
Material	Polycarbonate, glass fibre reinforced
Required plug-in slots	1

Note



Hose connection (pneumatic)



Deployment	Type	Order No.
Male, Female	HDC MPN 3	2637340000

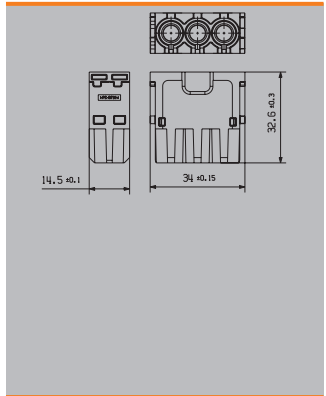

Note

Pneumatic contacts



Female		
HDC MPN 4.0 F		2637420000
HDC MPN 3.0 F		2637450000
HDC MPN 1.6 F		2637480000
Male		
HDC MPN 4.0 M		2637410000
HDC MPN 3.0 M		2637440000
HDC MPN 1.6 M		2637470000
Female with shut-off valve		
HDC MPN 4.0 SOF		2637430000
HDC MPN 3.0 SOF		2637460000
HDC MPN 1.6 SOF		2637490000
Note		

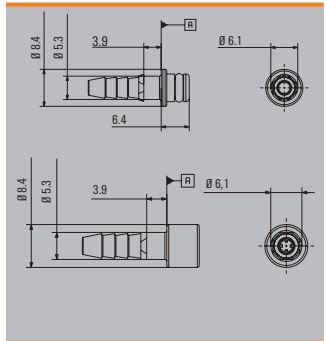

RockStar® Housings IP65 / NEMA Type 12, 4X

RockStar® Housings IP65 / NEMA Type 12, 4X	Introduction	D.2
	RockStar® Housings IP65 / NEMA Type 12, 4X	D.4
	Size 1 - 12	

D

RockStar® Housings IP65 / NEMA Type 12, 4X

Where something extra comes as standard. The high quality workmanship of RockStar® IP65 housings begins with the material from which all interlock mechanisms are made: stainless steel. It guarantees a long lifespan with high resistance to corrosion and impact. For the die-cast aluminium variants, a high-quality, multi-stage surface sealing provides years of safety and reliability – even under the most extreme conditions. With just one housing series, Weidmüller delivers the proper protective solution for your heavy-duty connector – so your choice is simple.

Other standard extras:

- A patented spring system provides a secure interlock and easier handling.
- Integrated threads: your choice of cable glands
- Integrated insulation strips: for worry-free transmission of higher voltages

RockStar® IP65 housings are available in twelve sizes and can be combined with all fixed-pole and modular inserts.



Sturdy

Stainless steel interlock systems and multi-stage surface sealing results in high durability



Reliable

Guaranteed protection against jets of water, corrosion, ice and rain, according to IEC 60529 and UL.



Practical

Laser labelling for permanent identification and faster allocation



RockStar® IP65 Housings / NEMA Type 12, 4X

Plastic housing

Size 1

Hood

Plug housing, cable entry sideways



Colour	Version	b (mm)	Type	Order No.
beige	w. thread	49.2	HDC 07A TWLU 1M20G	1788510000
beige	w. thread	49.2	HDC 07A TWLU 1PG11G	1652400000
black	w. thread	50	HDC 07A TOLU 1M20G BLK	2089000000

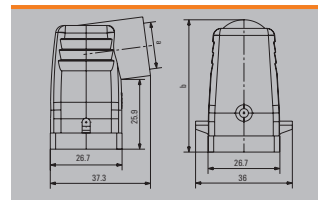

Plug housing, cable entry at top



Colour	Version	b (mm)	Type	Order No.
beige	w. thread	50	HDC 07A TOLU 1M20G	1788520000
beige	w. thread	50	HDC 07A TOLU 1PG11G	1652380000
black	w. thread	50	HDC 07A TOLU 1M20G BLK	2089000000

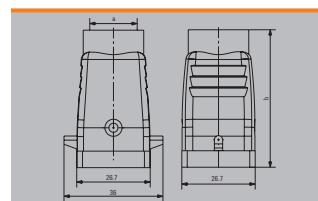

D

Plastic housing

Size 1

Base

Bulkhead housing



Colour	Version	b (mm)	Type	Order No.
beige	Side-locking	23	HDC 07A ALU	1652410000
black	Side-locking	23	HDC 07A ALU BLK	2088980000

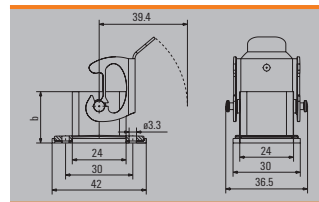

Bulkhead housing, angled



Colour	Version	b (mm)	Type	Order No.
beige	Side-locking	26.7	HDC 07A AWLU	1652420000

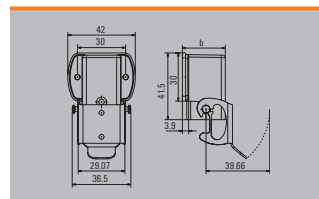

Base housing



Colour	Version	b (mm)	Type	Order No.
beige	Side-locking	41.5	HDC 07A SLU 1M20G	1788530000
beige	Side-locking	41.5	HDC 07A SLU 1PG11S	1652440000

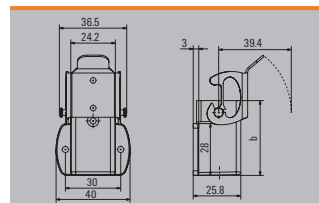

Coupling housing



Colour	Version	b (mm)	Type	Order No.
beige	w. thread	53.5	HDC 07A KOLU 1M20G	1788540000
beige	w. thread	53.5	HDC 07A KOLU 1PG11G	1652460000

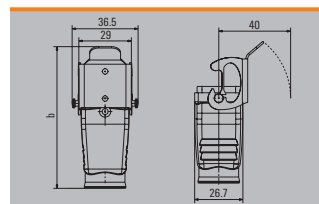

Screw mounting housing



Colour	Version	b (mm)	Type	Order No.
beige	w. thread	54	HDC 07A ELU 1PG13G	1900990000

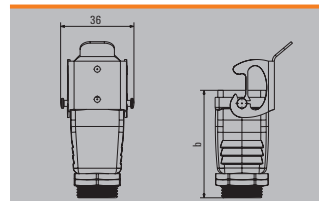

Cover



Version	Type	Order No.
with female	HDC 07A DMDL 2B0	1665770000
with male	HDC 07A DDDL 2B0	1665760000

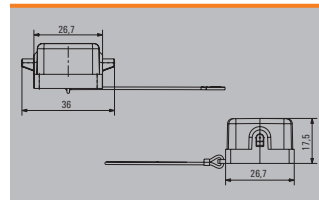

RockStar® IP65 Housings / NEMA Type 12, 4X

Metal housing

Size 1

Hood

Plug housing, cable entry sideways



Colour	Version	b (mm)	Type	Order No.
grey	w. thread	49.2	HDC 04A TWLW 1M20G	1788810000
grey	w. thread	49.2	HDC 04A TWLW 1PG11G	1652480000

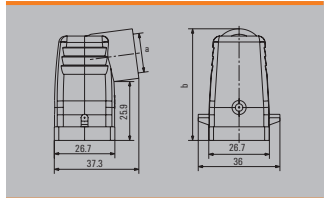

Plug housing, cable entry at top



Colour	Version	b (mm)	Type	Order No.
grey	w. thread	50	HDC 04A TOLU 1M16G	1206090000
grey	w. thread	50	HDC 04A TOLU 1M20G	1788820000
grey	w. thread	50	HDC 04A TOLU 1PG11G	1652470000

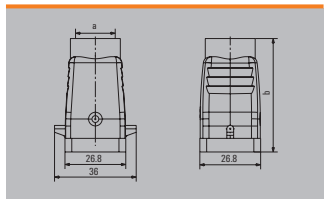

Cover



Version	Type	Order No.
with male	HDC 04A DDDL 1LB	1963690000

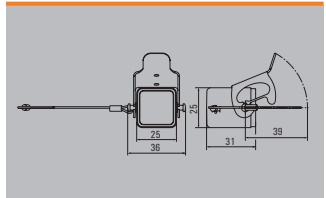

Metal housing

Size 1

Base

Bulkhead housing



Colour	Version	b (mm)	Type	Order No.
grey	Side-locking	23	HDC 04A ALU	1497600000

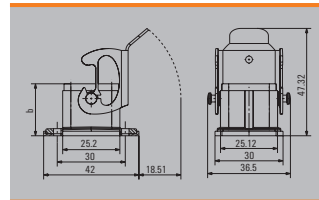

Bulkhead housing, angled



Colour	Version	b (mm)	Type	Order No.
grey	Side-locking	26.7	HDC 04A AWLU	1497700000

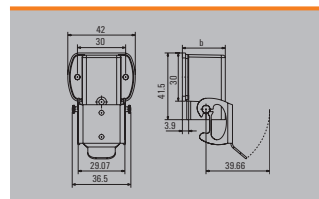

Base housing



Colour	Version	b (mm)	Type	Order No.
grey	Side-locking	41.5	HDC 04A SLU 1M20G	1788830000
grey	Side-locking	41.5	HDC 04A SLU 1PG11G	1652490000

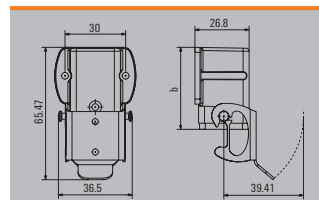

Coupling housing



Colour	Version	b (mm)	Type	Order No.
grey	w. thread	53.5	HDC 04A KOLU 1M20G	1788840000
grey	w. thread	53.5	HDC 04A KOLU 1PG11G	1652500000

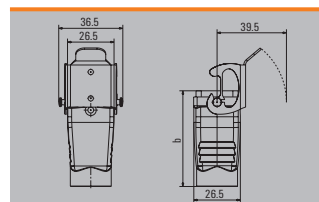

Screw mounting housing



Colour	Version	b (mm)	Type	Order No.
grey	w. thread	54	HDC 04A ELU 1M20G	1900320000
grey	w. thread	54	HDC 04A ELU 1PG13S	1900330000

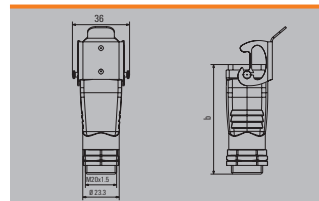

Cover



Version	Type	Order No.
with female	HDC 04A DMDL 2B0	1665750000
with male	HDC 04A DDDL 2B0	1665740000

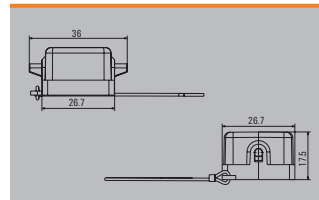

RockStar® IP65 Housings / NEMA Type 12, 4X

Plastic housing

Size HQ

Hood

Plug housing, cable entry sideways



Colour	Version	b (mm)	Type	Order No.
beige	w. thread	54	HDC HQP TSLU 1PG16	1003090000

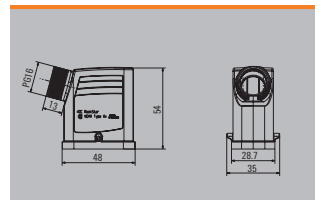

Plug housing, cable entry at top



Colour	Version	b (mm)	Type	Order No.
beige	w. thread	67	HDC HQP TOLU 1PG16	1003070000

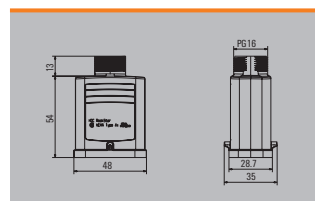

Base

Bulkhead housing



Colour	Version	b (mm)	Type	Order No.
beige	Side-locking	19.5	HDC HQP ALU	1003040000
beige	Side-locking	19.5	HDC HQP ALU CS	1354950000

Note CS: with lockable lever

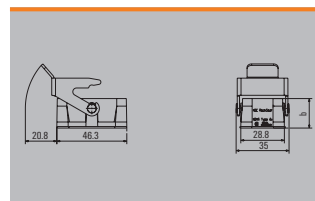

Bulkhead housing, angled



Colour	Version	b (mm)	Type	Order No.
beige	Side-locking	54.5	HDC HQP AWLU	1003060000

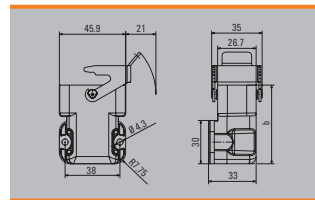

Base housing



Colour	Version	b (mm)	Type	Order No.
beige	Side-locking	54.5	HDC HQP SLU 1PG16	1003110000

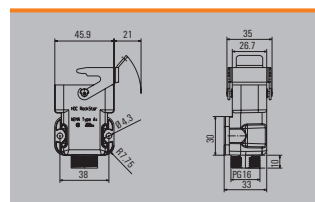

Coupling housing



Colour	Version	b (mm)	Type	Order No.
beige	w. thread	63.5	HDC HQP KOLU 1PG16	1003120000

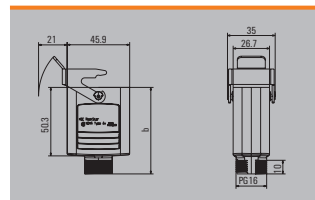

Cover



Version	Type	Order No.
with female	HDC HQP DMD 2B0	1003130000
with male	HDC HQP DOD 2B0	1003140000
with female	HDC HQP DMD 2B0 CS	1251660000
with male	HDC HQP DOD 2B0 CS	1251670000

Note for plastic and metal housings, with lockable lever

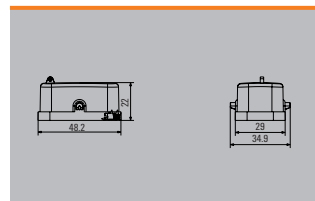

Die cast zinc housing (EMC)

Size HQ

Hood

Plug housing, cable entry sideways



Colour	Version	b (mm)	Type	Order No.
Silver grey	w. thread	60.5	HDC HQM TSLU 1PG21	1003100000

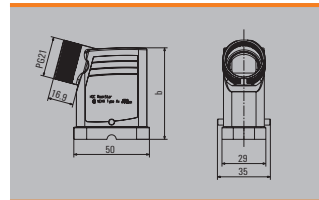

Plug housing, cable entry at top



Colour	Version	b (mm)	Type	Order No.
Silver grey	w. thread	77.5	HDC HQM TOLU 1PG21	1003080000

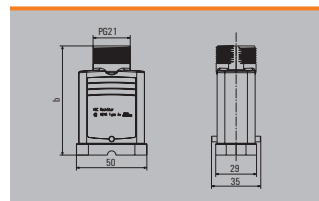

Base

Bulkhead housing



Colour	Version	b (mm)	Type	Order No.
Silver grey	Side-locking	20.5	HDC HQM ALU	1003050000
Silver grey	Side-locking	20.5	HDC HQM ALU CS	1251680000

Note CS: with lockable lever

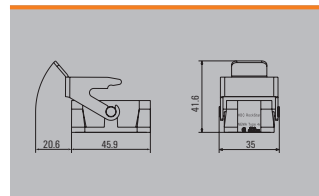

Cover



Version	Type	Order No.
with female	HDC HQP DMD 2B0	1003130000
with male	HDC HQP DOD 2B0	1003140000
with female	HDC HQP DMD 2B0 CS	1251660000
with male	HDC HQP DOD 2B0 CS	1251670000

Note for plastic and metal housings, with lockable lever

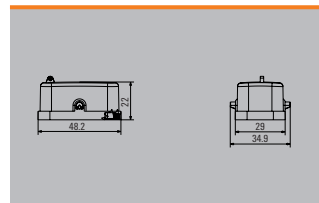

RockStar® IP65 Housings / NEMA Type 12, 4X

End locking, lower side

Size 2

Hood

Plug housing, cable entry sideways



Colour	Version	b (mm)	Type	Order No.
grey	w. thread	54	HDC 10A TSLU 1M20G	1967660000
grey	w. thread	68	HDC 15A TSLU 1M20G	1788860000
grey	w. thread	68	HDC 15A TSLU 1M25G	1788850000
grey	w. thread	54	HDC 10A TSLU 1PG16G	1663810000
grey	w. thread	68	HDC 15A TSLU 1PG16G	1663850000
grey	w. thread	68	HDC 15A TSLU 1PG21G	1663870000

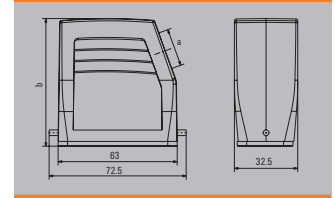

Plug housing, cable entry at top



Colour	Version	b (mm)	Type	Order No.
grey	w. thread	54	HDC 10A TOLU 1M20G	1788620000
grey	w. thread	54	HDC 10A TOLU 1M25G	1788610000
grey	w. thread	54	HDC 10A TOLU 2PG11G	1746170000
grey	w. thread	54	HDC 10A TOLU 1PG16G	1663930000
grey	w. thread	68	HDC 15A TOLU 1PG21G	1663990000

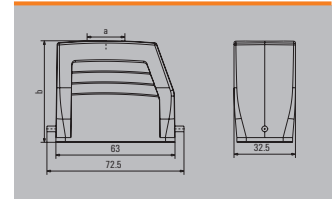

Cover



Version	Type	Order No.
For hoods	HDC 10A DDDL 1LB	1665890000

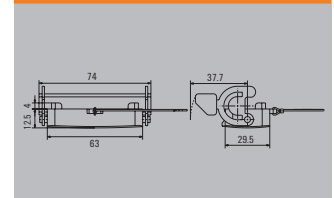

End locking, lower side

Size 2

Base

Bulkhead housing



Colour	Version	b (mm)	Type	Order No.
grey	End-locking	25	HDC 10A ALU	1664040000
grey	End-locking	37.5	HDC 10A ADLU	1664060000

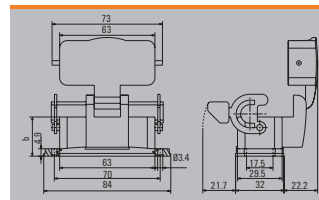

Bulkhead housing



Colour	Version	b (mm)	Type	Order No.
grey	End-locking	26	HDC 10A ALU SL	1021450000

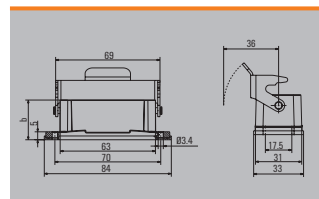

Base housing



Colour	Version	b (mm)	Type	Order No.
grey	End-locking	57	HDC 10A SLU 1M20G	1901100000
grey	End-locking	69.5	HDC 10A SDLU 1M20G	1901010000
grey	End-locking	57	HDC 10A SLU 2M20G	1788640000
grey	End-locking	69.5	HDC 10A SDLU 2M20G	1788660000
grey	End-locking	57	HDC 10A SLU 1M25G	1901160000
grey	End-locking	69.5	HDC 10A SDLU 1M25G	1901040000
grey	End-locking	57	HDC 10A SLU 2M25G	1788630000
grey	End-locking	69.5	HDC 10A SDLU 2M25G	1788650000
grey	End-locking	57	HDC 10A SLU 1PG16G	1664170000
grey	End-locking	69.5	HDC 10A SDLU 1PG16G	1664410000
grey	End-locking	57	HDC 10A SLU 2PG16G	1664190000
grey	End-locking	69.5	HDC 10A SDLU 2PG16G	1664420000
grey	End-locking	57	HDC 10A SLU 1PG21G	1664210000

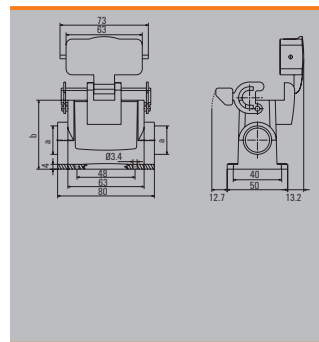

Coupling housing



Colour	Version	b (mm)	Type	Order No.
grey	w. thread	48	HDC 10A KLU 1M25G	1788670000
grey	w. thread	48	HDC 10A KLU 2PG09G	1783250000
grey	w. thread	48	HDC 10A KLU 1PG16G	1664560000

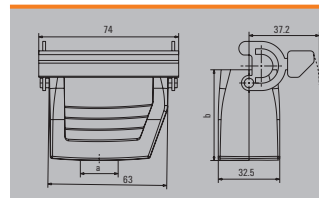

Cover



Version	Type	Order No.
For bases	HDC 10A DMDL 2B0	1665880000

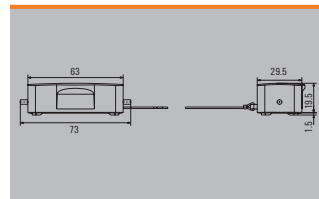

RockStar® IP65 Housings / NEMA Type 12, 4X

End locking, lower side

Size 3

Hood

Plug housing, cable entry sideways



Colour	Version	b (mm)	Type	Order No.
grey	w. thread	52	HDC 06B TSLU 1M20G	1788100000
grey	w. thread	52	HDC 06B TSLU 1M25G	1788090000
grey	w. thread	72	HDC 16D TSLU 1M25G	1787480000
grey	w. thread	72	HDC 16D TSLU 1M32G	1787470000
grey	w. thread	52	HDC 06B TSLU 1PG13G	1670530000
grey	w. thread	52	HDC 06B TSLU 1PG16G	1652520000
grey	w. thread	72	HDC 16D TSLU 1PG21G	1652560000
grey	w. thread	72	HDC 16D TSLU 1PG29G	1652580000

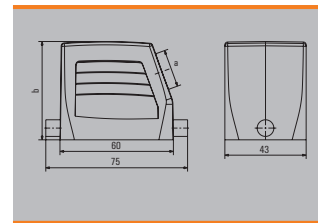

Plug housing, cable entry at top



Colour	Version	b (mm)	Type	Order No.
grey	w. thread	52	HDC 06B TOLU 1M20G	1788120000
grey	w. thread	52	HDC 06B TOLU 1M25G	1788110000
grey	w. thread	72	HDC 16D TOLU 1M25G	1787500000
grey	w. thread	72	HDC 16D TOLU 1M32G	1787490000
grey	w. thread	52	HDC 06B TOLU 1PG13G	1670500000
grey	w. thread	52	HDC 06B TOLU 1PG16G	1652640000
grey	w. thread	72	HDC 16D TOLU 1PG21G	1652680000
grey	w. thread	72	HDC 16D TOLU 1PG29G	1652700000

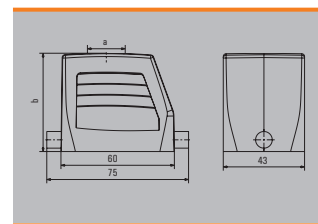

Cover



Version	Type	Order No.
For hoods	HDC 06B DMDL 1LB	1665210000
For hoods	HDC 06B DMDL 1LB N	2559730000

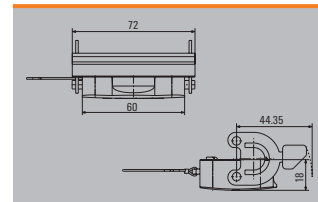

Note Note: N = Plastic locking lever with stainless steel inlay

End locking, lower side

Size 3

Base

Bulkhead housing



Colour	Version	b (mm)	Type	Order No.
grey	End-locking	29.3	HDC 06B ALU	1202100000
grey	End-locking	29.3	HDC 06B ALU N	2488560000
grey	End-locking	29.3	HDC 06B ADLU	1202500000
grey	End-locking	27.8	HDC 06B ALU O-RING	1019870000
grey	End-locking	29.3	HDC 06B ADLU N	2559320000

Note Note: N = Plastic locking lever with stainless steel inlay

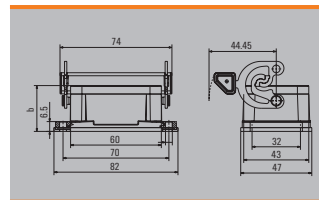

Base housing



Colour	Version	b (mm)	Type	Order No.
grey	End-locking	54	HDC 06B SLU 1M20G	1900460000
grey	End-locking	54	HDC 06B SLU 1M20G N	2637080000
grey	End-locking	54	HDC 06B SDLU 1M20G N	2560720000
grey	End-locking	54	HDC 06B SDLU 1M20G	1900360000
grey	End-locking	54	HDC 06B SLU 2M20G	1788140000
grey	End-locking	54	HDC 06B SDLU 2M20G	1788170000
grey	End-locking	54	HDC 06B SLU 2M25G	1788130000
grey	End-locking	54	HDC 06B SLU 2M20G N	2560850000
grey	End-locking	54	HDC 06B SLU 2M25G N	2560860000
grey	End-locking	54	HDC 06B SDLU 2M25G	1788160000
grey	End-locking	54	HDC 06B SDLU 2M20G N	2560820000
grey	End-locking	54	HDC 06B SDLU 2M25G N	2560830000
grey	End-locking	54	HDC 06B SLU 1M25G	1900480000
grey	End-locking	54	HDC 06B SLU 1M25G N	2560710000
grey	End-locking	54	HDC 06B SDLU 1M25G	1900380000
grey	End-locking	74	HDC 16D SLU 1M25G	1900880000
grey	End-locking	74	HDC 16D SDLU 1M25G	1900820000
grey	End-locking	74	HDC 16D SLU 2M25G	1787520000
grey	End-locking	74	HDC 16D SDLU 2M25G	1787540000
grey	End-locking	74	HDC 16D SLU 1M32G	1900900000
grey	End-locking	74	HDC 16D SLU 2M32G	1787510000
grey	End-locking	54	HDC 06B SLU 1PG16G	1652750000
grey	End-locking	54	HDC 06B SLU 1PG16G N	2560840000
grey	End-locking	54	HDC 06B SDLU 1PG16G	1652980000
grey	End-locking	54	HDC 06B SDLU 1PG16G N	2560810000
grey	End-locking	54	HDC 06B SLU 2PG16G	1652760000
grey	End-locking	74	HDC 16D SLU 2PG21G	1652840000
grey	End-locking	54	HDC 06B SDLU 2PG16G	1652990000

Note Note: N = Plastic locking lever with stainless steel inlay

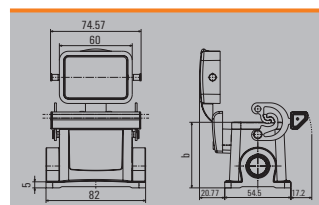

Coupling housing



Colour	Version	b (mm)	Type	Order No.
grey	w. thread	54.8	HDC 06B KLU 1M25G	1021330000
grey	w. thread	74.6	HDC 16D KLU 1PG21G	1653230000
grey	w. thread	54.8	HDC 06B KLU 1PG16G	1653200000

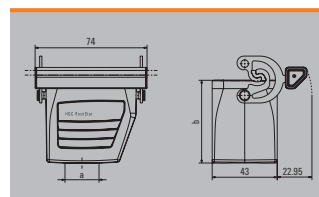

Cover



Version	Type	Order No.
For bases	HDC 06B DODL 2B0	1665200000

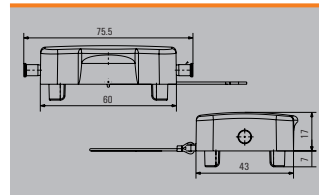

Counter-frame



Colour	Version	b (mm)	Type	Order No.
Silver grey			HDC IP65 06B FRAME M4	1081550000

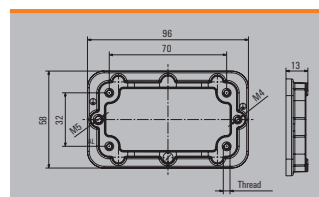

RockStar® IP65 Housings / NEMA Type 12, 4X

Side locking, lower side

Size 4

Hood

Plug housing, cable entry sideways



Colour	Version	b (mm)	Type	Order No.
grey	w. thread	52	HDC 10B TSBU 1M20G	1787560000
grey	w. thread	52	HDC 10B TSBU 1M25G	1787550000
grey	w. thread	72	HDC 24D TSBU 1M25G	1787240000
grey	w. thread	72	HDC 24D TSBU 1M32G	1787230000
grey	w. thread	52	HDC 10B TSBU 1PG16G	1654070000
grey	w. thread	52	HDC 10B TSBU 1PG21G	1654090000
grey	w. thread	72	HDC 24D TSBU 1PG21G	1654150000
grey	w. thread	72	HDC 24D TSBU 1PG29G	1654170000

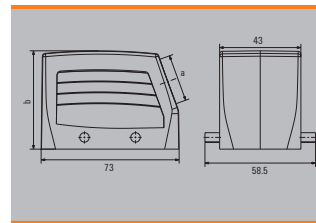

Plug housing, cable entry at top



Colour	Version	b (mm)	Type	Order No.
grey	w. thread	52	HDC 10B TOBU 1M20G	1787600000
grey	w. thread	52	HDC 10B TOBU 1M25G	1787590000
grey	w. thread	52	HDC 10B TOBU 2M25G CS	1263780000
grey	w. thread	72	HDC 24D TOBU 2M20G	1336600000
grey	w. thread	72	HDC 24D TOBU 1M25G	1787300000
grey	w. thread	72	HDC 24D TOBU 1M32G	1787290000
grey	w. thread	52	HDC 10B TOBU 1PG16G	1654220000
grey	w. thread	52	HDC 10B TOBU 1PG21G	1654240000
grey	w. thread	72	HDC 24D TOBU 1PG29G	1654320000

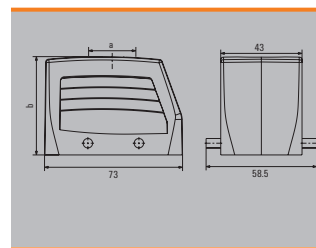

Cover



Version	Type	Order No.
For hoods	HDC 10B DMDQ 2QB	1665240000
For hoods	HDC 10B DMDQ 2QB N	2559740000

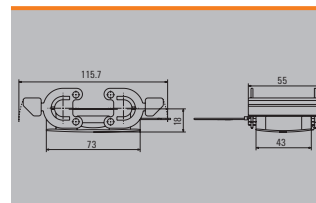

Note Note: N = Plastic locking lever with stainless steel inlay

Side locking, lower side

Size 4

Base

Bulkhead housing



Colour	Version	b (mm)	Type	Order No.
grey	Side-locking	29.5	HDC 10B ABU	1205000000
grey	Side-locking	29.5	HDC 10B ABU N	2488580000

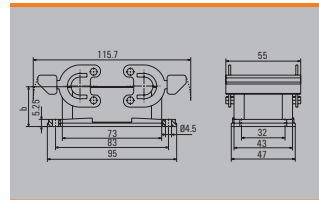

Note Note: N = Plastic locking lever with stainless steel inlay

Base housing



Colour	Version	b (mm)	Type	Order No.
grey	Side-locking	57	HDC 10B SBU 1M20G	1901360000
grey	Side-locking	57	HDC 10B SBU 1M20G N	2560880000
grey	Side-locking	57	HDC 10B SBU 2M20G	1787640000
grey	Side-locking	57	HDC 10B SBU 2M20G N	2560890000
grey	Side-locking	57	HDC 10B SBU 1M25G N	2560900000
grey	Side-locking	57	HDC 10B SBU 2M25G	1787630000
grey	Side-locking	57	HDC 10B SBU 1M25G	1901370000
grey	Side-locking	57	HDC 10B SBU 2M25G N	2560910000
grey	Side-locking	74	HDC 24D SBU 1M25G	1903210000
grey	Side-locking	74	HDC 24D SBU 2M25G	1787350000
grey	Side-locking	74	HDC 24D SBU 2M25G N	2560760000
grey	Side-locking	74	HDC 24D SBU 1M32G	1903220000
grey	Side-locking	74	HDC 24D SBU 1M32G N	2560990000
grey	Side-locking	74	HDC 24D SBU 2M32G	1787360000
grey	Side-locking	74	HDC 24D SBU 2M32G N	2561000000
grey	Side-locking	57	HDC 10B SBU 1PG16G	1654370000
grey	Side-locking	57	HDC 10B SBU 1PG16G N	2560730000
grey	Side-locking	57	HDC 10B SBU 2PG16G	1654380000
grey	Side-locking	57	HDC 10B SBU 2PG16G N	2560870000
grey	Side-locking	74	HDC 24D SBU 2PG21G	1654450000
grey	Side-locking	74	HDC 24D SBU 1PG29G	1654470000

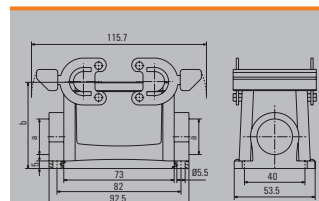

Note Note: N = Plastic locking lever with stainless steel inlay

Coupling housing



Colour	Version	b (mm)	Type	Order No.
grey	w. thread	54.65	HDC 10B KBU 1M20G	1787720000
grey	w. thread	54.65	HDC 10B KBU 1M20G N	2559860000
grey	w. thread	54.65	HDC 10B KBU 1M25G	1021250000
grey	w. thread	54.65	HDC 10B KBU 1PG16G	1654580000

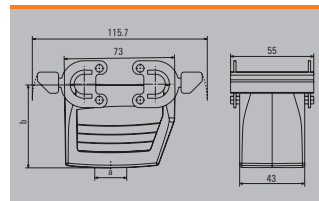

Note Note: N = Plastic locking lever with stainless steel inlay

Cover



Version	Type	Order No.
For bases	HDC 10B DDDQ 4B0	1665230000

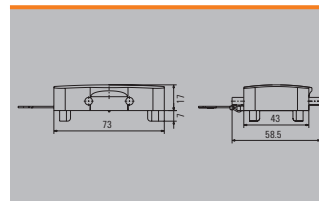

Counter-frame



Colour	Version	b (mm)	Type	Order No.
Silver grey			HDC IP65 10B FRAME M4	1081560000

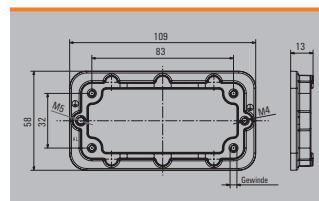

RockStar® IP65 Housings / NEMA Type 12, 4X

End locking, lower side

Size 4

Hood

Plug housing, cable entry sideways



Colour	Version	b (mm)	Type	Order No.
grey	w. thread	52	HDC 10B TSLU 1M25G	1787580000
grey	w. thread	72	HDC 24D TSLU 1M25G	1787280000
grey	w. thread	72	HDC 24D TSLU 1M32G	1787270000
grey	w. thread	52	HDC 10B TSLU 1PG16G	1655210000
grey	w. thread	72	HDC 24D TSLU 1PG21G	1655250000
grey	w. thread	72	HDC 24D TSLU 1PG29G	1655270000

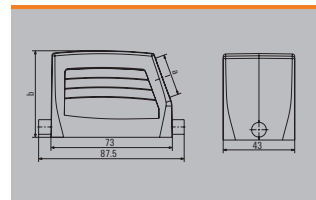

Plug housing, cable entry at top



Colour	Version	b (mm)	Type	Order No.
grey	w. thread	52	HDC 10B TOLLU 1M25G	1787620000
grey	w. thread	72	HDC 24D TOLLU 1M25G	1787340000
grey	w. thread	72	HDC 24D TOLLU 1M32G	1787330000
grey	w. thread	52	HDC 10B TOLLU 1PG16G	1655320000
grey	w. thread	72	HDC 24D TOLLU 1PG21G	1655360000
grey	w. thread	72	HDC 24D TOLLU 1PG29G	1655380000

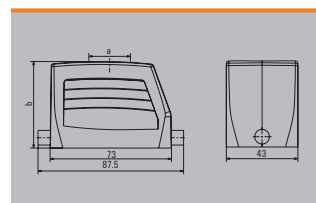

Base

Bulkhead housing



Colour	Version	b (mm)	Type	Order No.
grey	End-locking	29	HDC 10B ALU	1206100000
grey	End-locking	29	HDC 10B ADLU	1206500000

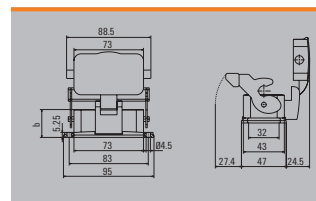

Base housing



Colour	Version	b (mm)	Type	Order No.
grey	End-locking	57	HDC 10B SLU 1M20G	1901620000
grey	End-locking	57	HDC 10B SDLU 1M20G	1901570000
grey	End-locking	57	HDC 10B SLU 2M20G	1787660000
grey	End-locking	57	HDC 10B SDLU 2M20G	1787700000
grey	End-locking	57	HDC 10B SLU 1M25G	1901640000
grey	End-locking	74	HDC 24D SDLU 1M25G	1903410000
grey	End-locking	57	HDC 10B SLU 2M25G	1787650000
grey	End-locking	74	HDC 24D SDLU 2M25G	1787420000
grey	End-locking	74	HDC 24D SDLU 1M32G	1903560000
grey	End-locking	74	HDC 24D SDLU 1M32G	1903510000
grey	End-locking	74	HDC 24D SLU 2M32G	1787370000
grey	End-locking	74	HDC 24D SDLU 2M32G	1787410000
grey	End-locking	57	HDC 10B SLU 2PG16G	1655470000
grey	End-locking	57	HDC 10B SDLU 2PG16G	1655680000

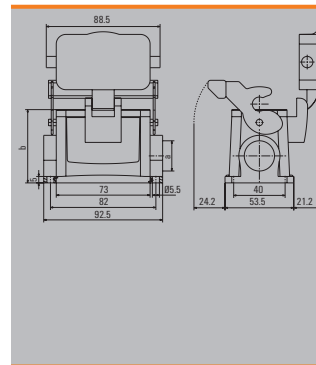

Coupling housing



Colour	Version	b (mm)	Type	Order No.
grey	w. thread	55	HDC 10B KLU 1M20G	1787740000
grey	w. thread	55	HDC 10B KLU 1M25G	1787730000
grey	w. thread	75	HDC 24D KLU 1M25G	1787460000
grey	w. thread	75	HDC 24D KLU 1M32G	1787450000
grey	w. thread	55	HDC 10B KLU 1PG16G	1655890000

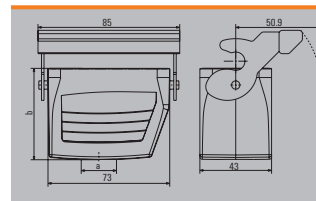

Counter-frame



Colour	Version	b (mm)	Type	Order No.
Silver grey			HDC IP65 10B FRAME M4	1081560000

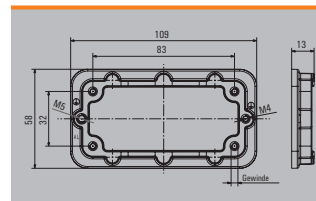

Side locking, upper side

Size 4

Hood

Plug housing, cable entry sideways



Colour	Version	b (mm)	Type	Order No.
grey	w. thread	52	HDC 10B TSBO 1M25G	1787570000
grey	w. thread	72	HDC 24D TSBO 1M25G	1787260000
grey	w. thread	72	HDC 24D TSBO 1M32G	1787250000
grey	w. thread	52	HDC 10B TSBO 1PG16G	1654750000
grey	w. thread	72	HDC 24D TSBO 1PG16G	1654810000
grey	w. thread	72	HDC 24D TSBO 1PG21G	1654790000

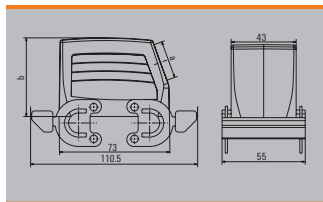

Plug housing, cable entry at top



Colour	Version	b (mm)	Type	Order No.
grey	w. thread	52	HDC 10B TOBO 1M25G	1787610000
grey	w. thread	52	HDC 10B TOBO 1PG16G	1654860000
grey	w. thread	72	HDC 24D TOBO 1PG29G	1654920000

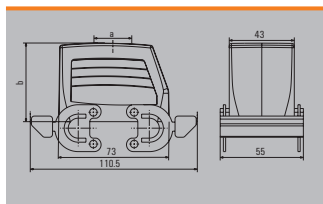

Cover



Version	Type	Order No.
For hoods	HDC 10B DMDQ 4B0	1665250000

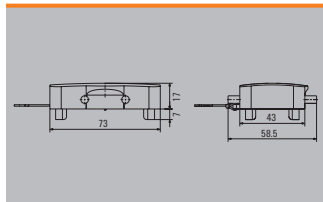

Base

Bulkhead housing



Colour	Version	b (mm)	Type	Order No.
grey		29	HDC 10B ABO	1052430000
grey	Side-locking	51.6	HDC 10B ADBO	1205600000

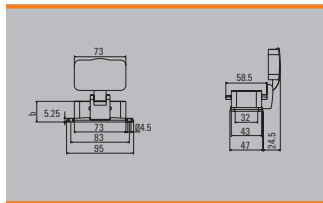

Base housing



Colour	Version	b (mm)	Type	Order No.
grey	Side-locking	57	HDC 10B SDBO 1M20G	1901490000
grey	Side-locking	57	HDC 10B SDBO 2M20G	1787680000
grey	Side-locking	57	HDC 10B SDBO 1M25G	1901510000
grey	Side-locking	74	HDC 24D SDBO 1M25G	1903370000
grey	Side-locking	57	HDC 10B SDBO 2M25G	1787670000
grey	Side-locking	74	HDC 24D SDBO 2M25G	1787400000
grey	Side-locking	57	HDC 10B SDBO 2PG16G	1655000000

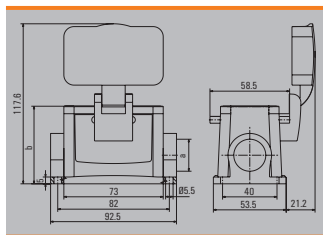

Cover



Version	Type	Order No.
For bases	HDC 10B DDDQ 2QB	1009080000

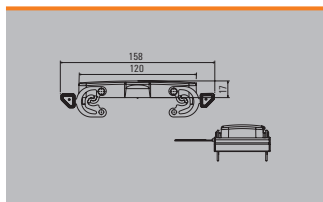

Counter-frame



Colour	Version	b (mm)	Type	Order No.
Silver grey			HDC IP65 10B FRAME M4	1081560000

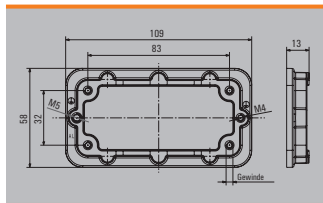

RockStar® IP65 Housings / NEMA Type 12, 4X

Central-Locking

Size 4

Hood

Plug housing, cable entry sideways



Colour	Version	b (mm)	Type	Order No.
grey	w. thread	72	HDC 24D TSZO 1M25G	1903610000
grey	w. thread	72	HDC 24D TSZO 1PG21G	1968360000

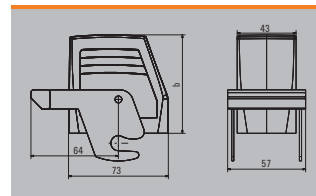

Base

Bulkhead housing



Colour	Version	b (mm)	Type	Order No.
grey	Central-Locking	29.25	HDC 10B AZO	1901700000

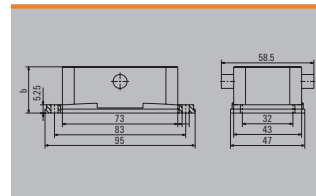

Base housing



Colour	Version	b (mm)	Type	Order No.
grey	Central-Locking	74	HDC 24D SZO 2PG21G	1968350000

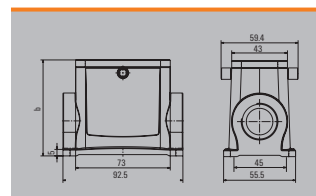

Counter-frame



Colour	Version	b (mm)	Type	Order No.
Silver grey			HDC IP65 10B FRAME M4	1081560000

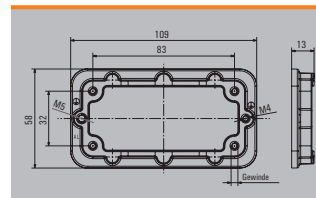

End locking, lower side

Size 5

Hood

Plug housing, cable entry sideways



Colour	Version	b (mm)	Type	Order No.
grey	w. thread	58	HDC 16A TSLU 1M20G	1041760000
grey	w. thread	72	HDC 25A TSLU 1M20G	1788680000
grey	w. thread	58	HDC 16A TSLU 1M25G	1788740000
grey	w. thread	72	HDC 25A TSLU 1M25G	1788690000
grey	w. thread	58	HDC 16A TSLU 1PG16G	1664690000
grey	w. thread	72	HDC 25A TSLU 1PG16G	1664730000
grey	w. thread	72	HDC 25A TSLU 1PG21G	1664750000

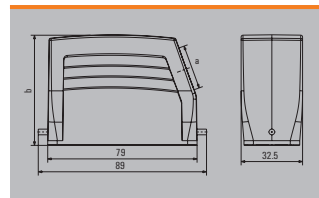

Plug housing, cable entry at top



Colour	Version	b (mm)	Type	Order No.
grey	w. thread	72	HDC 25A TOLL 1M20G	1788710000
grey	w. thread	58	HDC 16A TOLL 1M25G	1788750000
grey	w. thread	72	HDC 25A TOLL 1M25G	1788700000
grey	w. thread	58	HDC 16A TOLL 1PG16G	1664810000
grey	w. thread	72	HDC 25A TOLL 1PG21G	1664870000

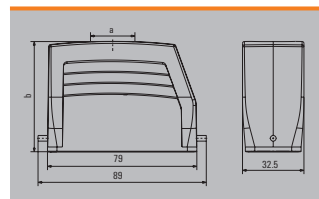

Cover



Version	Type	Order No.
For hoods	HDC 16A DDDL 1LB	1665900000

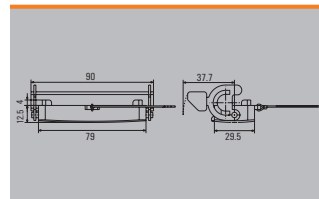

Base

Bulkhead housing



Colour	Version	b (mm)	Type	Order No.
grey	End-locking	26.25	HDC 16A ALU	1664920000
grey	End-locking	26.25	HDC 16A ADLU	1664940000

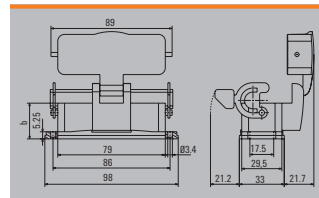

Base housing



Colour	Version	b (mm)	Type	Order No.
grey	End-locking	57	HDC 16A SLU 1M20G	1934720000
grey	End-locking	57	HDC 16A SDLU 1M20G	1934710000
grey	End-locking	57	HDC 16A SLU 2M20G	1788770000
grey	End-locking	57	HDC 16A SDLU 2M20G	1788790000
grey	End-locking	57	HDC 16A SLU 1M25G	1902330000
grey	End-locking	57	HDC 16A SLU 2M25G	1788760000
grey	End-locking	57	HDC 16A SDLU 2M25G	1788780000
grey	End-locking	57	HDC 16A SLU 2PG16G	1665070000
grey	End-locking	57	HDC 16A SDLU 2PG16G	1665300000
grey	End-locking	57	HDC 16A SLU 1PG21G	1665090000

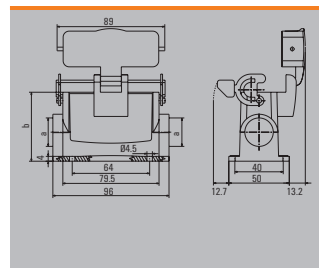

Coupling housing



Colour	Version	b (mm)	Type	Order No.
grey	w. thread	52.62	HDC 16A KLU 1M25G	1788800000
grey	w. thread	52.62	HDC 16A KLU 1PG16G	1665450000

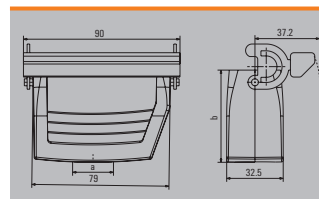

RockStar® IP65 Housings / NEMA Type 12, 4X

End locking, lower side

Size 5

Base

Cover



Version	Type	Order No.
For bases	HDC 16A DMDL 2B0	1665910000

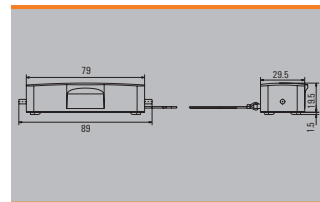

Side locking, lower side

Size 6

Hood

Plug housing, cable entry sideways



Colour	Version	b (mm)	Type	Order No.
grey	w. thread	61	HDC 16B TSBU 1M25G	1788180000
grey	w. thread	76	HDC 40D TSBU 1M25G	1787010000
grey	w. thread	76	HDC 40D TSBU 1M32G	1787000000
grey	w. thread	61	HDC 16B TSBU 1M40G	1809620000
grey	w. thread	76	HDC 40D TSBU 1M40G	1904800000
grey	w. thread	61	HDC 16B TSBU 1PG21G	1656480000
grey	w. thread	76	HDC 40D TSBU 1PG21G	1656520000
grey	w. thread	76	HDC 40D TSBU 1PG29G	1656540000

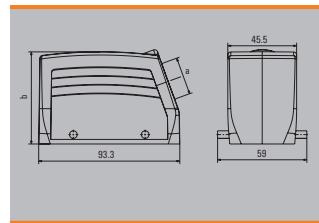

Plug housing, cable entry at top



Colour	Version	b (mm)	Type	Order No.
grey	w. thread	61	HDC 16B TOBU 1M25G	1788210000
grey	w. thread	76	HDC 40D TOBU 1M25G	1787070000
grey	w. thread	76	HDC 40D TOBU 2M25	1208380000
			HDC 40D TOBU 1M32G1M20G	1229120000
grey	w. thread	76	HDC 40D TOBU 1M32G	1787060000
grey	w. thread	76	HDC 40D TOBU 2M32G CS	1532320000
grey			HDC 40D TOBU 1M40G CS	1114890000
grey	w. thread	61	HDC 16B TOBU 1PG21G	1656590000
grey	w. thread	76	HDC 40D TOBU 1PG21G	1656630000
grey	w. thread	76	HDC 40D TOBU 1PG29G	1656650000

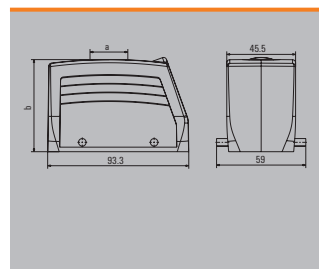

Plug housing, cable entry at top and sideways



Colour	Version	b (mm)	Type	Order No.
grey	w. thread	76	HDC 40D TBU 2M32G CSS	1927480000
grey	w. thread	76	HDC 40D TOBU 2M25G2M16G CS	1251020000



Cover



Version	Type	Order No.
For hoods	HDC 16B DMDQ 20B	1665270000

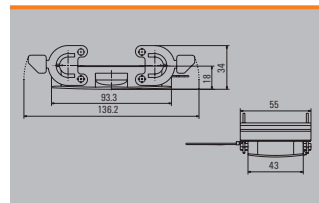

RockStar® IP65 Housings / NEMA Type 12, 4X

Side locking, lower side

Size 6

Base

Bulkhead housing



Colour	Version	b (mm)	Type	Order No.
grey	Side-locking	29	HDC 16B ABU	1208600000
grey	Side-locking	29	HDC 16B ABU N	2488590000

Note Note: N = Plastic locking lever with stainless steel inlay

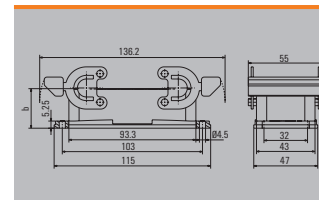

Base housing



Colour	Version	b (mm)	Type	Order No.
grey	Side-locking	64	HDC 16B SBU 1M25G	1899980000
grey	Side-locking	64	HDC 16B SBU 1M25G N	2560740000
grey	Side-locking	64	HDC 16B SBU 2M25G	1788240000
grey	Side-locking	64	HDC 16B SBU 2M25G N	2560930000
grey	Side-locking	84	HDC 40D SBU 1M25G	1902970000
grey	Side-locking	84	HDC 40D SBU 2M25G	1787120000
grey	Side-locking	84	HDC 40D SBU 2M25G N	2561020000
grey	Side-locking	84	HDC 40D SBU 1M32G	1902990000
grey	Side-locking	84	HDC 40D SBU 1M32G N	2561030000
grey	Side-locking	84	HDC 40D SBU 2M32G	1787110000
grey	Side-locking	84	HDC 40D SBU 2M32G N	2561040000
grey	Side-locking	64	HDC 16B SBU 1PG21G	1656720000
grey	Side-locking	64	HDC 16B SBU 1PG21G N	2560940000
grey	Side-locking	64	HDC 16B SBU 2PG21G	1656730000
grey	Side-locking	64	HDC 16B SBU 2PG21G N	2560950000
grey	Side-locking	84	HDC 40D SBU 2PG21G	1656810000
grey	Side-locking	84	HDC 40D SBU 1PG29G	1656830000
grey	Side-locking	84	HDC 40D SBU 2PG29G	1656840000

Note Note: N = Plastic locking lever with stainless steel inlay

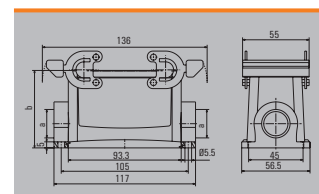

Coupling housing



Colour	Version	b (mm)	Type	Order No.
grey	w. thread	78.6	HDC 40D KBU 1M25G	1787200000
grey	w. thread	79	HDC 40D KBU 1M25G N	2559890000
grey	w. thread	78.6	HDC 40D KBU 1M32G	1787190000
grey	w. thread	79	HDC 40D KBU 1M32G N	2559900000
grey	w. thread	79	HDC 40D KBU 2M32G N	2545510000
grey	w. thread	64	HDC 16B KBU 1PG21G	1657270000
grey	w. thread	78.6	HDC 40D KBU 1PG21G	1657310000

Note Note: N = Plastic locking lever with stainless steel inlay

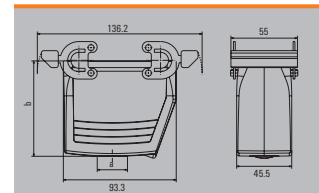

Cover



Version	Type	Order No.
For bases	HDC 16B DDDQ 480	1665260000

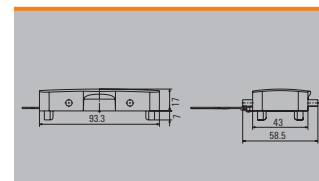

Counter-frame



Colour	Version	b (mm)	Type	Order No.
Silver grey		14	HDC IP65 16B FRAME M4	1081570000

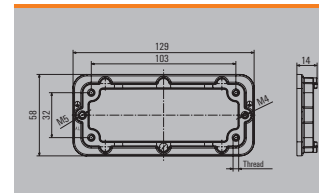

End locking, lower side

Size 6

Hood

Plug housing, cable entry sideways



Colour	Version	b (mm)	Type	Order No.
grey	w. thread	61	HDC 16B TSLU 1M25G	1788200000
grey	w. thread	76	HDC 40D TSLU 1M25G	1787050000
grey	w. thread	61	HDC 16B TSLU 1M32G	1804640000
grey	w. thread	76	HDC 40D TSLU 1M32G	1787040000
grey	w. thread	76	HDC 40D TSLU 1M40G	1804650000
grey	w. thread	61	HDC 16B TSLU 1PG21G	1657850000
grey	w. thread	76	HDC 40D TSLU 1PG21G	1657890000
grey	w. thread	76	HDC 40D TSLU 1PG29G	1657910000

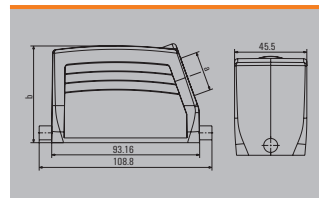

Plug housing, cable entry at top



Colour	Version	b (mm)	Type	Order No.
grey	w. thread	61	HDC 16B TOLU 1M25G	1788230000
grey	w. thread	61	HDC 16B TOLU 1M32G	1804630000
grey	w. thread	76	HDC 40D TOLU 1M32G	1787100000
grey	w. thread		HDC 40D TOLU 1M40G	1139680000
grey	w. thread	61	HDC 16B TOLU 1PG21G	1657960000
grey	w. thread	76	HDC 40D TOLU 1PG29G	1658020000

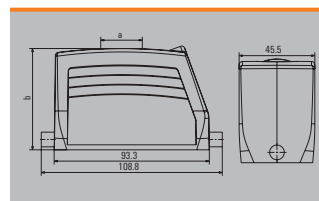

Base

Bulkhead housing



Colour	Version	b (mm)	Type	Order No.
grey	End-locking	30.3	HDC 16B ALU	1209700000
grey	End-locking	30.3	HDC 16B ADLU	1210100000

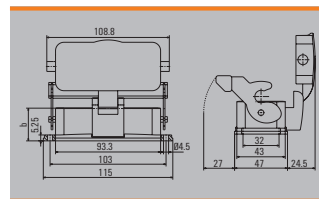

Base housing



Colour	Version	b (mm)	Type	Order No.
grey	End-locking	64	HDC 16B SLU 1M25G	1900170000
grey	End-locking	102	HDC 40D SDLU 1M25G	1903070000
grey	End-locking	64	HDC 16B SLU 2M25G	1788250000
grey	End-locking	82	HDC 16B SDLU 2M25G	1788270000
grey	End-locking	102	HDC 40D SDLU 2M25G	1787180000
grey	End-locking	84	HDC 40D SLU 1M32G	1903110000
grey	End-locking	102	HDC 40D SDLU 1M32G	1903080000
grey	End-locking	84	HDC 40D SLU 2M32G	1804660000
grey	End-locking	102	HDC 40D SDLU 2M32G	1787170000
grey	End-locking	64	HDC 16B SLU 1PG21G	1658110000
grey	End-locking	82	HDC 16B SDLU 1PG21G	1658320000
grey	End-locking	64	HDC 16B SLU 2PG21G	1658120000
grey	End-locking	82	HDC 16B SDLU 2PG21G	1658330000
grey	End-locking	102	HDC 40D SDLU 1PG29G	1658410000

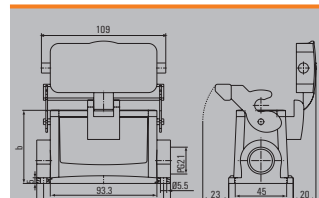

Coupling housing



Colour	Version	b (mm)	Type	Order No.
grey	w. thread	65.1	HDC 16B KLU 1M25G	1788290000
grey	w. thread	78.6	HDC 40D KLU 1M25G	1787220000

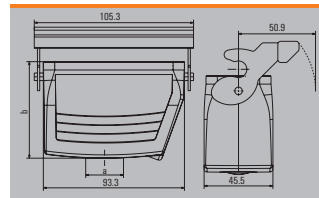

Counter-frame



Colour	Version	b (mm)	Type	Order No.
Silver grey		14	HDC IP65 16B FRAME M4	1081570000

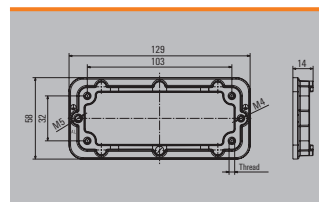

RockStar® IP65 Housings / NEMA Type 12, 4X

Side locking, upper side

Size 6

Hood

Plug housing, cable entry sideways



Colour	Version	b (mm)	Type	Order No.
grey	w. thread	61	HDC 16B TSBO 1M25G	1788190000
grey	w. thread	61	HDC 16B TSBO 1M32G	1269040000
grey	w. thread	76	HDC 40D TSBO 1M25G	1787030000
grey	w. thread	76	HDC 40D TSBO 1M32G	1787020000
grey	w. thread	76	HDC 40D TSBO 1M40G	1202230000
grey	w. thread	61	HDC 16B TSBO 1PG21G	1657380000
grey	w. thread	76	HDC 40D TSBO 1PG21G	1657420000

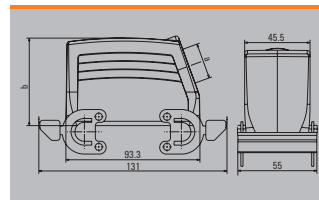

Plug housing, cable entry at top



Colour	Version	b (mm)	Type	Order No.
grey	w. thread	61	HDC 16B TOBO 1M25G	1788220000
grey	w. thread	61	HDC 16B TOBO 1PG21G	1657490000
grey	w. thread	76	HDC 40D TOBO 1PG29G	1657550000

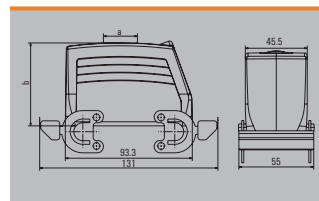

Cover



Version	Type	Order No.
For hoods	HDC 16B DMDQ 4B0	1665620000

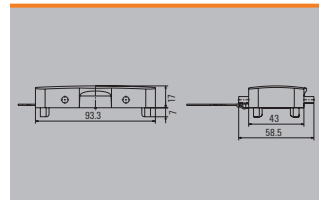

Base

Bulkhead housing



Colour	Version	b (mm)	Type	Order No.
grey	Side-locking	29.05	HDC 16B ADBO	1209200000

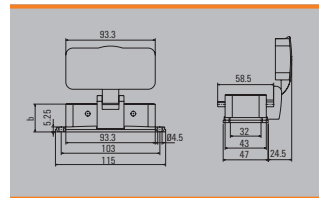

Base housing



Colour	Version	b (mm)	Type	Order No.
grey	Side-locking	64	HDC 16B SDBO 1M25G	1900080000
grey	Side-locking	64	HDC 16B SDBO 2M25G	1788260000
grey	Side-locking	64	HDC 16B SDBO 2PG21G	1657640000

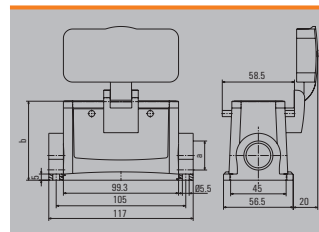

Cover



Version	Type	Order No.
For bases	HDC 16B DDDQ 2QB	1009090000

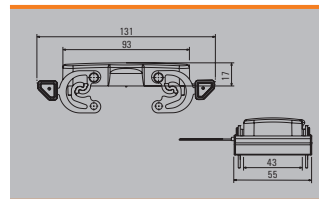

Counter-frame



Colour	Version	b (mm)	Type	Order No.
Silver grey		14	HDC IP65 16B FRAME M4	1081570000

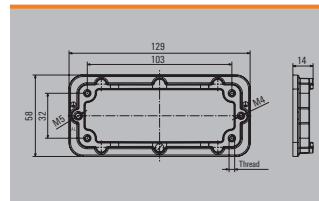

Side locking, lower side

Size 7

Hood

Plug housing, cable entry sideways



Colour	Version	b (mm)	Type	Order No.
grey	w. thread	77	HDC 32A TSBU 1M25G	1787960000
grey	w. thread	77	HDC 32A TSBU 1M32G	1787950000
grey	w. thread	77	HDC 32A TSBU 1PG21G	1665670000
grey	w. thread	77	HDC 32A TSBU 1PG29G	1665690000

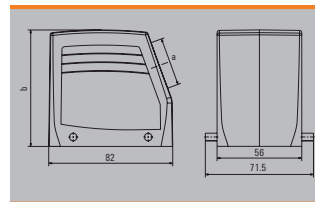

Plug housing, cable entry at top



Colour	Version	b (mm)	Type	Order No.
grey	w. thread	77	HDC 32A TOBU 1M32G	1787990000
grey	w. thread	77	HDC 32A TOBU 1PG21G	1665790000
grey	w. thread	77	HDC 32A TOBU 1PG29G	1665810000

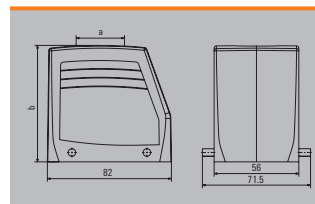

Cover



Version	Type	Order No.
For hoods	HDC 32A DMDQ 2QB	1665930000

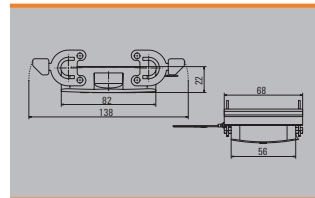

Base

Bulkhead housing



Colour	Version	b (mm)	Type	Order No.
grey	Side-locking	30	HDC 32A ABU	1665860000

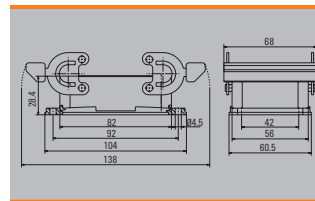

Base housing



Colour	Version	b (mm)	Type	Order No.
grey	Side-locking	75	HDC 32A SBU 1M25G	1903870000
grey	Side-locking	75	HDC 32A SBU 2M25G	1788040000
grey	Side-locking	75	HDC 32A SBU 2PG21G	1665980000
grey	Side-locking	75	HDC 32A SBU 1PG29G	1666010000

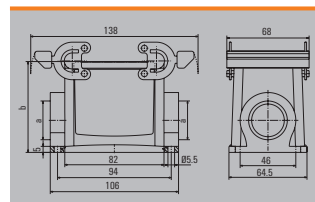

Coupling housing



Colour	Version	b (mm)	Type	Order No.
grey	w. thread	77	HDC 32A KBU 1M25G	1788080000
grey	w. thread	77	HDC 32A KBU 1M32G	1788070000

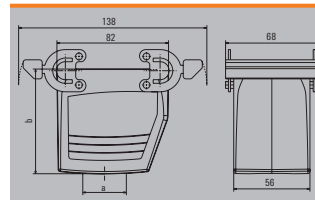

Cover



Version	Type	Order No.
For bases	HDC 32A DODQ 4B0	1665920000

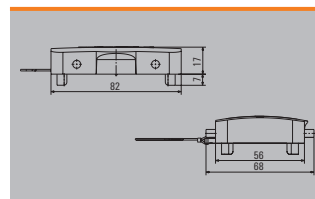

RockStar® IP65 Housings / NEMA Type 12, 4X

Side locking, upper side

Size 7

Hood

Plug housing, cable entry sideways



Colour	Version	b (mm)	Type	Order No.
grey	w. thread	77	HDC 32A TSBO 1M25G	1787980000
grey	w. thread	77	HDC 32A TSBO 1M32G	1787970000
grey	w. thread	77	HDC 32A TSBO 1PG29G	1666270000

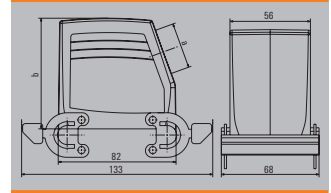

Plug housing, cable entry at top



Colour	Version	b (mm)	Type	Order No.
grey	w. thread	77	HDC 32A TOBO 1M32G	1788010000

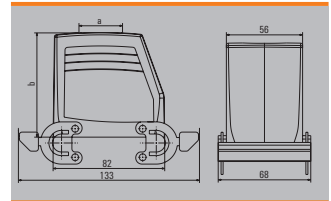

Base

Bulkhead housing



Colour	Version	b (mm)	Type	Order No.
grey	Side-locking	30	HDC 32A ADBO	1666440000

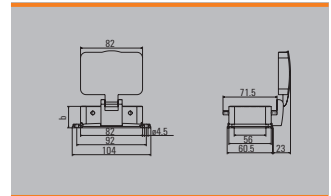

Base housing



Colour	Version	b (mm)	Type	Order No.
grey	Side-locking	75	HDC 32A SDBO 1M25G	1903900000
grey	Side-locking	75	HDC 32A SDBO 2M25G	1788060000
grey	Side-locking	75	HDC 32A SDBO 1M32G	1903910000
grey	Side-locking	75	HDC 32A SDBO 2M32G	1788050000
grey	Side-locking	75	HDC 32A SDBO 1PG21G	1666550000
grey	Side-locking	75	HDC 32A SDBO 1PG29G	1666590000

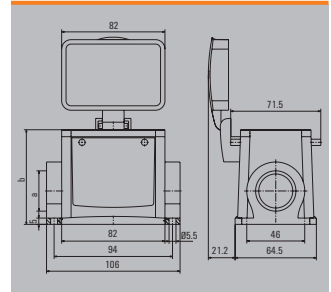

Side locking, lower side

Size 8

Hood

Plug housing, cable entry sideways



Colour	Version	b (mm)	Type	Order No.
grey	w. thread	62.58	HDC 24B TSBU 1M25G	1787760000
grey	w. thread	76	HDC 64D TSBU 1M25G	1786780000
grey	w. thread	62.58	HDC 24B TSBU 1M32G	1787750000
grey	w. thread	76	HDC 64D TSBU 1M32G	1786770000
grey	w. thread	62.58	HDC 24B TSBU 1M40G	1902480000
grey	w. thread	76	HDC 64D TSBU 1M40G	1809630000
grey	w. thread	62.58	HDC 24B TSBU 1PG21G	1661230000
grey	w. thread	76	HDC 64D TSBU 1PG21G	1661300000
grey	w. thread	62.58	HDC 24B TSBU 1PG29G	1661240000
grey	w. thread	76	HDC 64D TSBU 1PG29G	1661320000

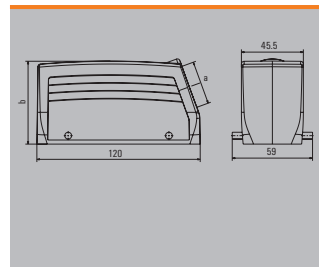

Plug housing, cable entry at top



Colour	Version	b (mm)	Type	Order No.
grey	w. thread	62.58	HDC 24B TOBU 1M25G	1787820000
grey	w. thread	62.58	HDC 24B TOBU 2M25G CS	1365030000
grey	w. thread	62.58	HDC 24B TOBU 1M32G	1787810000
grey	w. thread	76	HDC 64D TOBU 1M32G	1786830000
grey	w. thread	76	HDC 64D TOBU 2M32G	1009710000
grey	w. thread	62.58	HDC 24B TOBU 1M40G	1902980000
grey	w. thread	76	HDC 64D TOBU 1M40G	1045560000
grey	w. thread	62.58	HDC 24B TOBU 1PG21G	1661370000
grey	w. thread	76	HDC 64D TOBU 1PG21G	1661440000
grey	w. thread	62.58	HDC 24B TOBU 1PG29G	1661380000
grey	w. thread	76	HDC 64D TOBU 1PG29G	1661460000

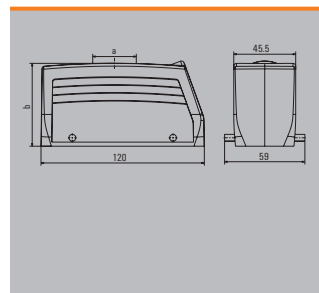

Plug housing, cable entry at top and sideways



Colour	Version	b (mm)	Type	Order No.
grey	w. thread		HDC 24B TBU 2M40G CS	1131600000
grey	w. thread	76	HDC 64D TBU 2M32G CS	1324520000



Cover



Version	Type	Order No.
For hoods	HDC 24B DMDQ 2QB	1665640000
For hoods	HDC 24B DMDQ 2QB N	2559760000

Note: N = Plastic locking lever with stainless steel inlay

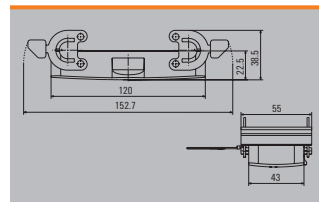

Hood

XXL plug housing, cable entry sideways



Colour	Version	b (mm)	Type	Order No.
grey	w. thread	76	HDC 64D TSBU 1M50G	1111130000

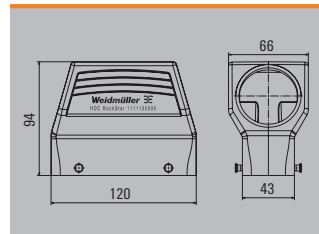

XXL plug housing, cable entry on top



Colour	Version	b (mm)	Type	Order No.
grey	w. thread	76	HDC 64D TOBU 1M50G	1111140000

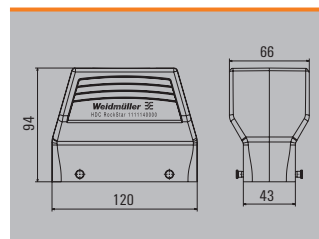

Side locking, lower side

Size 8

Base

Bulkhead housing



Colour	Version	b (mm)	Type	Order No.
grey	Side-locking	29.5	HDC 24B ABU	1212400000
grey	Side-locking	29.5	HDC 24B ABU N	2488600000

Note Note: N = Plastic locking lever with stainless steel inlay

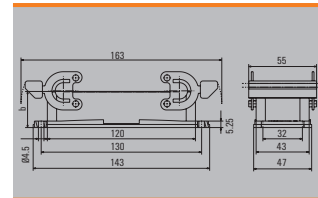

Base housing



Colour	Version	b (mm)	Type	Order No.
grey	Side-locking	64	HDC 24B SBU 2M25G	1787870000
grey	Side-locking	64	HDC 24B SBU 1M25G	1901150000
grey	Side-locking	84	HDC 64D SBU 1M25G	1904340000
grey	Side-locking	64	HDC 24B SBU 2M25G N	2560970000
grey	Side-locking	64	HDC 24B SBU 1M25G N	2560960000
grey	Side-locking	84	HDC 64D SBU 2M25G	1786890000
grey	Side-locking	84	HDC 64D SBU 2M25G N	2561060000
grey	Side-locking	84	HDC 64D SBU 1M32G N	2561050000
grey	Side-locking	84	HDC 64D SBU 2M32G	1786880000
grey	Side-locking	84	HDC 64D SBU 1M32G	1904350000
grey	Side-locking	64	HDC 24B SBU 1PG21G	1661510000
grey	Side-locking	64	HDC 24B SBU 1PG21G N	2560750000
grey	Side-locking	64	HDC 24B SBU 2PG21G	1661520000
grey	Side-locking	84	HDC 64D SBU 2PG21G	1661590000

Note Note: N = Plastic locking lever with stainless steel inlay

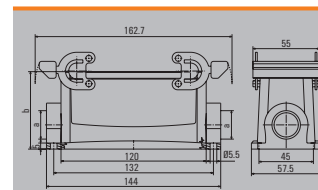

Coupling housing



Colour	Version	b (mm)	Type	Order No.
grey	w. thread	65	HDC 24B KBU 1M25G	1787920000
grey	w. thread	65	HDC 24B KBU 1M25G N	2559870000
grey	w. thread	65	HDC 24B KBU 2M32G N	2559880000
grey	w. thread	79	HDC 64D KBU 1M32G	1786960000
grey	w. thread	79	HDC 64D KBU 1M32G N	2559910000
grey	w. thread	65	HDC 24B KBU 1PG21G	1661720000
grey	w. thread	65	HDC 24B KBU 1PG29G	1661730000

Note Note: N = Plastic locking lever with stainless steel inlay

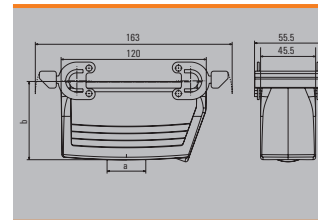

Cover



Version	Type	Order No.
For bases	HDC 24B DODQ 480	1665630000

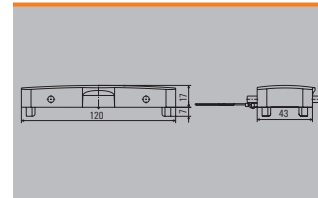

Counter-frame



Colour	Version	b (mm)	Type	Order No.
Silver grey		17	HDC IP65 24B FRAME M4	1081580000

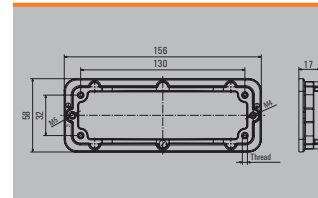

End locking, lower side

Size 8

Hood

Plug housing, cable entry sideways



Colour	Version	b (mm)	Type	Order No.
grey	w. thread	62.58	HDC 24B TSLU 1M25G	1787800000
grey	w. thread	62.58	HDC 24B TSLU 1M32G	1787790000
grey	w. thread	76	HDC 64D TSLU 1M32G	1786810000
grey	w. thread	76	HDC 64D TSLU 1M40G	1804610000
grey	w. thread	76	HDC 64D TSLU 1PG21G	1662470000
grey	w. thread	62.58	HDC 24B TSLU 1PG21G	1662390000
grey	w. thread	62.58	HDC 24B TSLU 1PG29G	1662410000
grey	w. thread	76	HDC 64D TSLU 1PG29G	1662490000

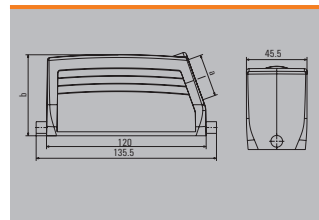

Plug housing, cable entry at top



Colour	Version	b (mm)	Type	Order No.
grey	w. thread	62.58	HDC 24B TOLU 1M25G	1787860000
grey	w. thread	76	HDC 64D TOLU 1M25G	1786870000
grey	w. thread	62.58	HDC 24B TOLU 1M32G	1787850000
grey	w. thread	76	HDC 64D TOLU 1M32G	1786860000
grey	w. thread	76	HDC 64D TOLU 1M40G	1983470000
grey	w. thread	62.58	HDC 24B TOLU 1PG21G	1662540000
grey	w. thread	76	HDC 64D TOLU 1PG21G	1662610000
grey	w. thread	62.58	HDC 24B TOLU 1PG29G	1662550000
grey	w. thread	76	HDC 64D TOLU 1PG29G	1662630000

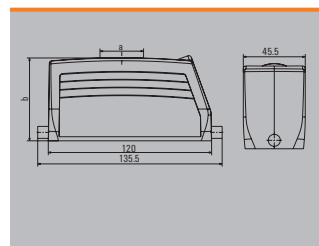

Hood

XXL plug housing, cable entry sideways



Colour	Version	b (mm)	Type	Order No.
grey	w. thread	76	HDC 64D TSLU 1M50G	1111150000

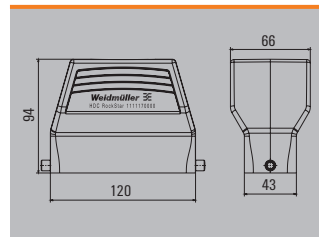

XXL plug housing, cable entry on top



Colour	Version	b (mm)	Type	Order No.
grey	w. thread	76	HDC 64D TOLU 1M50G	1111170000

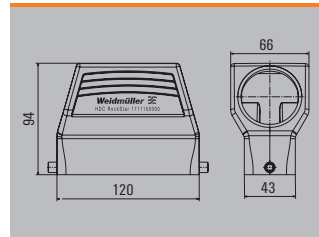

End locking, lower side

Size 8

Base

Bulkhead housing



Colour	Version	b (mm)	Type	Order No.
grey	End-locking	29.3	HDC 24B ALU	1213900000
grey	End-locking	29.3	HDC 24B ADLU	1214300000

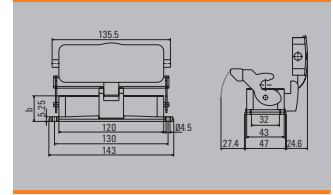

Base housing



Colour	Version	b (mm)	Type	Order No.
grey	End-locking	64	HDC 24B SLU 1M25G	1901560000
grey	End-locking	64	HDC 24B SDLU 1M25G	1901480000
grey	End-locking	84	HDC 64D SLU 1M25G	1904480000
grey	End-locking	84	HDC 64D SDLU 1M25G	1904430000
grey	End-locking	64	HDC 24B SLU 2M25G	1787880000
grey	End-locking	64	HDC 24B SDLU 2M25G	1787900000
grey	End-locking	84	HDC 64D SLU 2M25G	1786910000
grey	End-locking	84	HDC 64D SDLU 2M25G	1786950000
grey	End-locking	84	HDC 64D SLU 1M32G	1904490000
grey	End-locking	84	HDC 64D SDLU 1M32G	1904440000
grey	End-locking	84	HDC 64D SLU 2M32G	1786900000
grey	End-locking	84	HDC 64D SDLU 2M32G	1786940000
grey	End-locking	64	HDC 24B SLU 2PG21G	1662720000
grey	End-locking	64	HDC 24B SDLU 2PG21G	1214500000
grey	End-locking	84	HDC 64D SDLU 2PG29G	1663040000

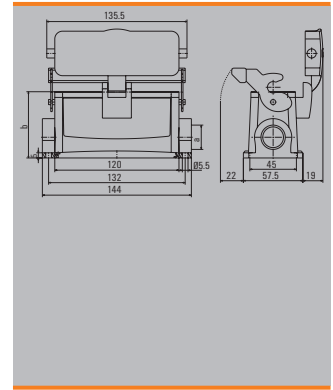

Coupling housing



Colour	Version	b (mm)	Type	Order No.
grey	w. thread	66	HDC 24B KLU 1M25G	1968340000

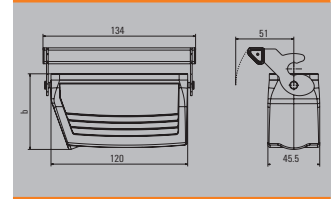

Counter-frame



Colour	Version	b (mm)	Type	Order No.
Silver grey		17	HDC IP65 24B FRAME M4	1081580000

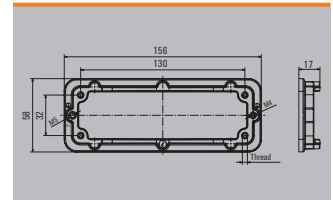

Side locking, upper side

Size 8

Hood

Plug housing, cable entry sideways



Colour	Version	b (mm)	Type	Order No.
grey	w. thread	62.58	HDC 24B TSBO 1M25G	1787780000
grey	w. thread	76	HDC 64D TSBO 1M25G	1786800000
grey	w. thread	62.58	HDC 24B TSBO 1M32G	1787770000
grey	w. thread	76	HDC 64D TSBO 1M32G	1786790000
grey	w. thread	62.58	HDC 24B TSBO 1PG21G	1661860000
grey	w. thread	76	HDC 64D TSBO 1PG21G	1661940000
grey	w. thread	62.58	HDC 24B TSBO 1PG29G	1661880000
grey	w. thread	76	HDC 64D TSBO 1PG29G	1661960000

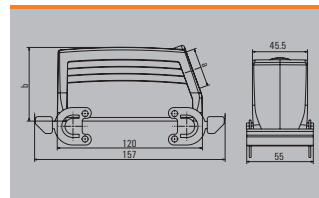

Plug housing, cable entry at top



Colour	Version	b (mm)	Type	Order No.
grey	w. thread	62.58	HDC 24B TOBO 1M32G	1787830000
grey	w. thread	76	HDC 64D TOBO 2M32G CS	1253270000
grey	w. thread	76	HDC 64D TOBO 1PG21G	1662080000
grey	w. thread	62.58	HDC 24B TOBO 1PG29G	1662020000
grey	w. thread	76	HDC 64D TOBO 1PG29G	1662100000

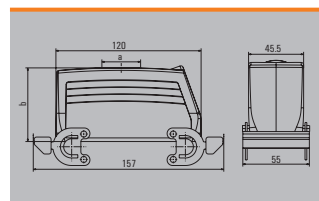

Cover



Version	Type	Order No.
For hoods	HDC 24B DMDQ 4B0	1665650000

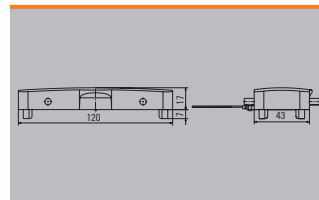

Base

Bulkhead housing



Colour	Version	b (mm)	Type	Order No.
grey	Side-locking	29	HDC 24B ABO	1967910000
grey	Side-locking	29	HDC 24B ADBO	1213300000

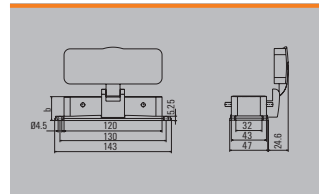

Base housing



Colour	Version	b (mm)	Type	Order No.
grey	Side-locking	84	HDC 64D SDBO 1M32G	1904400000
grey	Side-locking	84	HDC 64D SDBO 2M32G	1786920000
grey	Side-locking	64	HDC 24B SDBO 2PG21G	1662180000
grey	Side-locking	84	HDC 64D SDBO 1PG29G	1662280000

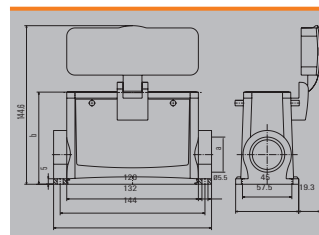

Cover



Version	Type	Order No.
For bases	HDC 24B DDDQ 20B	1009100000

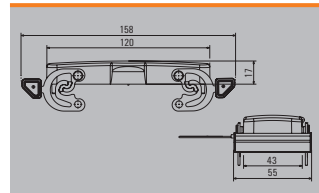

RockStar® IP65 Housings / NEMA Type 12, 4X

Central-locking

Size 8

Hood

Plug housing, cable entry sideways



Colour	Version	b (mm)	Type	Order No.
grey	w. thread	76	HDC 64D TSZO 1M40G	1904690000
grey	w. thread	76	HDC 64D TSZO 1PG21G	1663370000
grey	w. thread	76	HDC 64D TSZO 1PG29G	1663390000

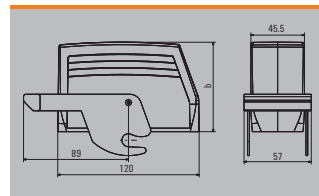

Base

Bulkhead housing



Colour	Version	b (mm)	Type	Order No.
grey	Central-locking	29	HDC 24B AZO	1611350000

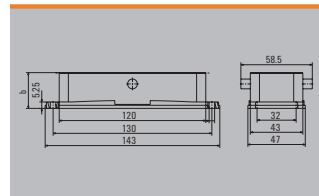

Base housing



Colour	Version	b (mm)	Type	Order No.
grey	Central-locking	79.7	HDC 64D SZO 2PG29G	1968370000

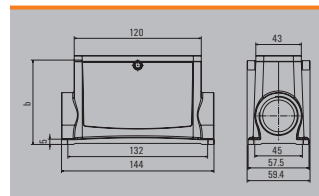

Counter-frame



Colour	Version	b (mm)	Type	Order No.
Silver grey		17	HDC IP65 24B FRAME M4	1081580000

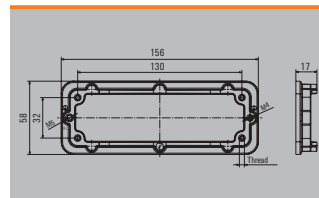

End locking, lower side

Size 9

Hood

Plug housing, cable entry sideways



Colour	Version	b (mm)	Type	Order No.
grey	w. thread	78	HDC 48A TSLU 1M32G	1788550000
grey	w. thread	78	HDC 48A TSLU 1PG29G	1666710000

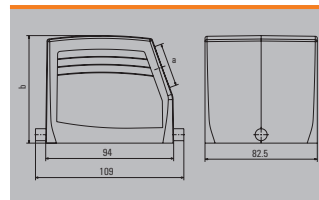

Plug housing, cable entry at top



Colour	Version	b (mm)	Type	Order No.
grey	w. thread	78	HDC 48A TOLU 1M32G	1788560000
grey	w. thread	78	HDC 48A TOLU 1PG29G	1666730000

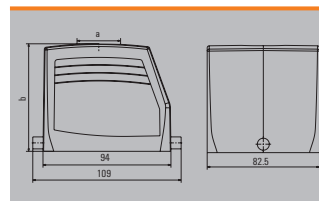

Base

Bulkhead housing



Colour	Version	b (mm)	Type	Order No.
grey	End-locking	40	HDC 48A ALU	1666740000
grey	End-locking	40	HDC 48A ADLU	1666750000

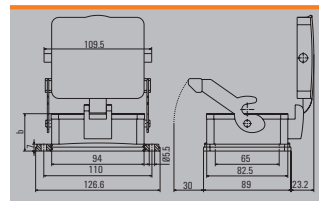

Base housing



Colour	Version	b (mm)	Type	Order No.
grey	End-locking	79	HDC 48A SLU 2M32G	1788570000
grey	End-locking	79	HDC 48A SLU 1PG29G	1666770000
grey	End-locking	79	HDC 48A SDLU 1PG29G	1666810000

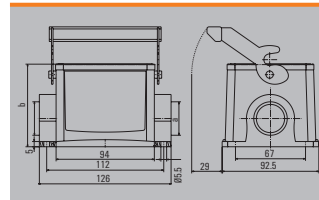

RockStar® IP65 Housings / NEMA Type 12, 4X

Side locking, lower side

Size 10

Hood

Plug housing, cable entry sideways



Colour	Version	b (mm)	Type	Order No.
grey	w. thread	79	HDC 32B TSBU 1M32G	1788400000
grey	w. thread	79	HDC 32B TSBU 1PG29G	1666840000

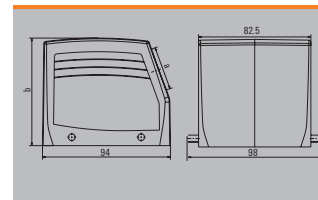

Plug housing, cable entry at top



Colour	Version	b (mm)	Type	Order No.
grey	w. thread	79	HDC 32B TOBU 1M32G	1788430000
grey	w. thread	79	HDC 32B TOBU 1PG29G	1666870000

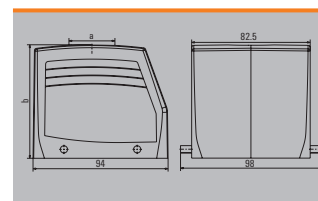

Base

Bulkhead housing



Colour	Version	b (mm)	Type	Order No.
grey	Side-locking	38	HDC 32B ABU	1217800000

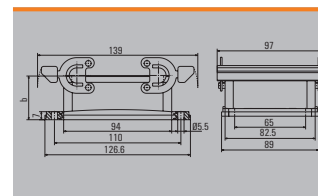

Base housing



Colour	Version	b (mm)	Type	Order No.
grey	Side-locking	79	HDC 32B SBU 1M32G	1902600000
grey	Side-locking	79	HDC 32B SBU 2M32G	1788460000
			HDC 32B SBU 2M40G CS	1301990000
grey	Side-locking	79	HDC 32B SBU 2PG29G	1666920000
grey	Side-locking	79	HDC 32B SBU 1PG36G	1902610000
grey	Side-locking	79	HDC 32B SBU 2PG36G	1902640000

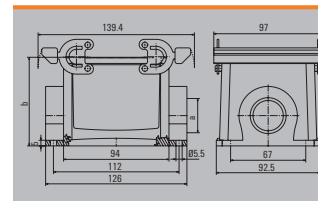

Coupling housing



Colour	Version	b (mm)	Type	Order No.
grey	w. thread	83	HDC 32B KBU 1M40G	1902730000
grey	w. thread	83	HDC 32B KBU 1PG29G	1902740000
grey	w. thread	83	HDC 32B KBU 1PG36G	1902750000

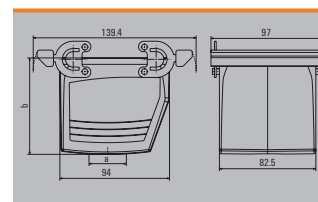

Cover



Version	Type	Order No.
For bases	HDC 32B D00Q 480	1165790000

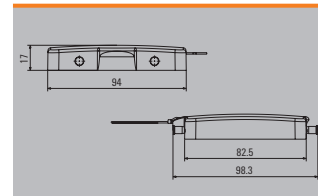

End locking, lower side

Size 10

Hood

Plug housing, cable entry sideways



Colour	Version	b (mm)	Type	Order No.
grey	w. thread	79	HDC 32B TSLU 1M32G	1788420000
grey	w. thread	79	HDC 32B TSLU 1PG29G	1667120000

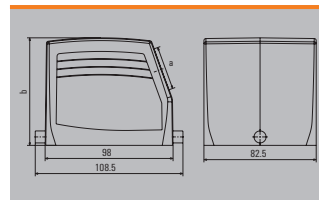

Plug housing, cable entry at top



Colour	Version	b (mm)	Type	Order No.
grey	w. thread	79	HDC 32B TOLU 1M32G	1788450000
grey	w. thread	79	HDC 32B TOLU 1PG29G	1219300000

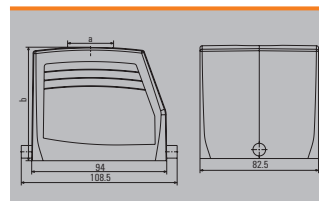

Base

Bulkhead housing



Colour	Version	b (mm)	Type	Order No.
grey	End-locking	38	HDC 32B ALU	1219500000
	End-locking	55	HDC 32B ADLU	1219800000

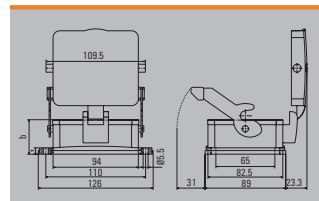

Base housing



Colour	Version	b (mm)	Type	Order No.
grey	End-locking	79	HDC 32B SLU 1M32G	1902670000
grey	End-locking	96	HDC 32B SDLU 1M32G	1902650000
grey	End-locking	79	HDC 32B SLU 2M32G	1788470000
grey	End-locking	96	HDC 32B SDLU 2M32G	1788490000

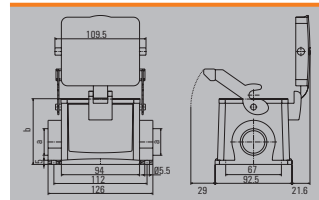

Coupling housing



Colour	Version	b (mm)	Type	Order No.
grey	w. thread	83	HDC 32B KLU 1M32G	1788500000

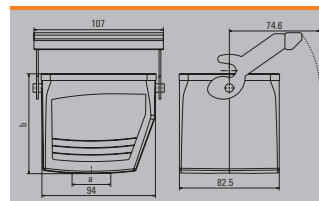

RockStar® IP65 Housings / NEMA Type 12, 4X

Side locking, upper side

Size 10

Hood

Plug housing, cable entry sideways



Colour	Version	b (mm)	Type	Order No.
grey	w. thread	79	HDC 32B TSBO 1M32G	1788410000

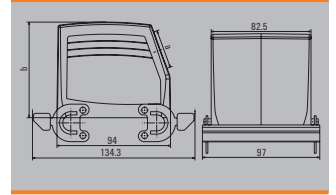

Base

Bulkhead housing



Colour	Version	b (mm)	Type	Order No.
grey	Side-locking	55	HDC 32B ADBO	1218800000

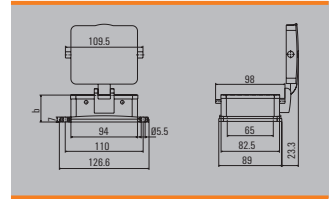

End locking, lower side

Size 12

Hood

Plug housing, cable entry sideways



Colour	Version	b (mm)	Type	Order No.
grey	w. thread	94	HDC 48B TSLU 1M32G	1788320000
grey	w. thread	94	HDC 48B TSLU 1M40G	1788310000
grey	w. thread	94	HDC 48B TSLU 1M50G	1788300000
grey	w. thread	94	HDC 48B TSLU 1PG29G	1650850000
grey	w. thread	94	HDC 48B TSLU 1PG36G	1650860000
grey	w. thread	94	HDC 48B TSLU 1PG42G	1670470000

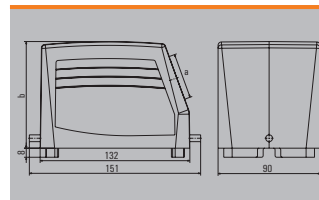

Plug housing, cable entry at top



Colour	Version	b (mm)	Type	Order No.
grey	w. thread	94	HDC 48B TOLU 1M32G	1788350000
grey	w. thread	94	HDC 48B TOLU 1M40G	1788340000
grey	w. thread	94	HDC 48B TOLU 1M50G	1788330000
grey	w. thread	94	HDC 48B TOLU 1PG29G	1650980000
grey	w. thread	94	HDC 48B TOLU 1PG36G	1651000000

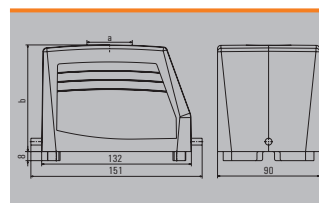

Base

Bulkhead housing



Colour	Version	b (mm)	Type	Order No.
grey	End-locking	62	HDC 48B ADLU	1222900000
grey	End-locking	41.5	HDC 48B ALU	1295600000

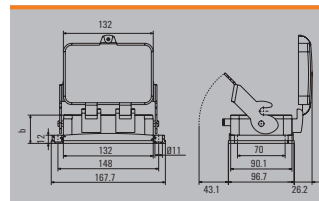

Base housing



Colour	Version	b (mm)	Type	Order No.
grey	End-locking	100	HDC 48B SLU 1M32G	1904190000
grey	End-locking	120	HDC 48B SDLU 1M32G	1904150000
grey	End-locking	100	HDC 48B SLU 2M32G	1788370000
grey	End-locking	120	HDC 48B SDLU 2M32G	1788390000
grey	End-locking	100	HDC 48B SLU 2M40G	1788360000
grey	End-locking	120	HDC 48B SDLU 2M40G	1983500000
grey	End-locking	120	HDC 48B SDLU 2M50G	1983510000
grey	End-locking	100	HDC 48B SLU 1PG29G	1651100000
grey	End-locking	120	HDC 48B SDLU 1PG29G	1799810000
grey	End-locking	120	HDC 48B SDLU 2PG29G	1667560000

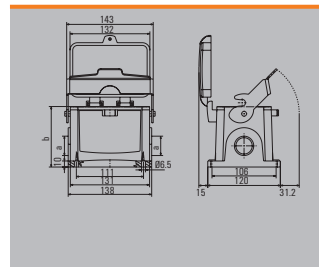

RockStar® Housings IP65 / EMC

RockStar® Housings IP65 / EMC	Introduction	E.2
	RockStar® Housings IP65 / EMC	E.4
	Size 3, 4, 6 and 8	

Optimal protection against electric or electromagnetic fields

HDC IP65 EMC enclosure with above-average shielding properties

Protection against electrical and electromagnetic influences is essential in many industries to ensure fault-free operation. RockStar® HDC IP65 EMC enclosures can be used wherever optimal shielding with low transfer impedance is required.

The labyrinth structure on the housing enables reliable data transmission, which reduces the risk of system failure and increases productivity. The FPM sealing material permits RockStar® HDC IP65 EMC enclosures to be used indoors as well as outdoors. With only one type of enclosure, the number of storage items decreases significantly. The conductive and corrosion-resistant surface coating meets increased environmental requirements and lowers procurement costs.

Your special advantages

- Effective labyrinth structure for secure data transmission
- Extremely reliable FPM seals for indoor and outdoor use
- Internal O-ring seal for quick and easy installation



Effective labyrinth structure

Excellent shielding effect is achieved due to the unique labyrinth structure and the large contact area between the bulkhead mount and hoods.



Corrosion-resistant, conductive surface

The unique surface finish makes the housing impact-resistant, electrically conductive and corrosion-resistant—even in seawater environments.

**Robust sealing material**

The ozone- and UV-resistant sealing material FPM withstands an extended temperature range from -40 to $+150$ °C.



RockStar® Housing IP65 / EMC

Housing selection RockStar® IP65 EMC

Size 3

Hood

Plug housing, cable entry sideways



Version	b (mm)	Type	Order No.
w. thread		HDC 16D TSLU 1M32G EMC	2543960000

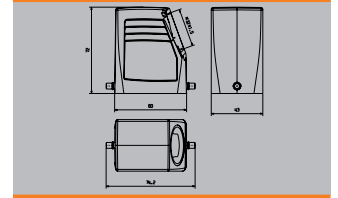

Plug housing, cable entry at top



Version	b (mm)	Type	Order No.
w. thread		HDC 16D TOLU 1M32G EMC	2543970000

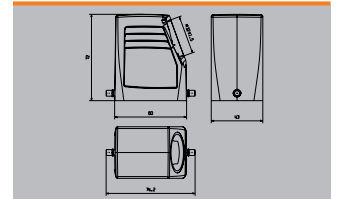

Base

Bulkhead housing



Version	b (mm)	Type	Order No.
End-locking		HDC 06B ALU EMC	2542230000

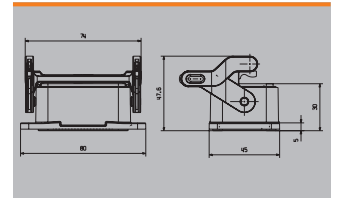

Housing selection RockStar® IP65 EMC

Size 4

Hood

Plug housing, cable entry sideways



Version	b (mm)	Type	Order No.
w. thread		HDC 24D TSBU 1M32G EMC	2544010000

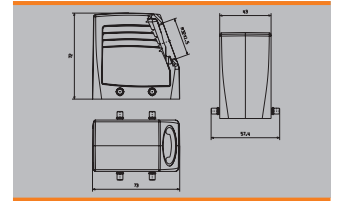

Plug housing, cable entry at top



Version	b (mm)	Type	Order No.
w. thread		HDC 24D TOBU 1M32G EMC	2544020000

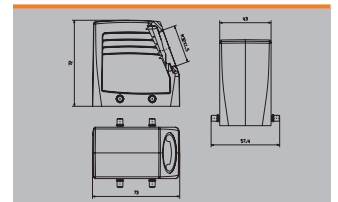

Base

Bulkhead housing



Version	b (mm)	Type	Order No.
Side-locking		HDC 10B ABU EMC	2542310000

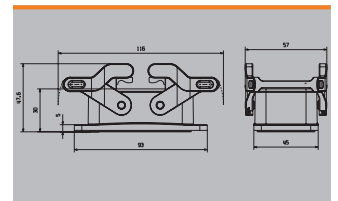

RockStar® Housing IP65 / EMC

Housing selection RockStar® IP65 EMC

Size 6

Hood

Plug housing, cable entry sideways



Version	b (mm)	Type	Order No.
w. thread		HDC 40D TSBU 1M40G EMC	2544030000

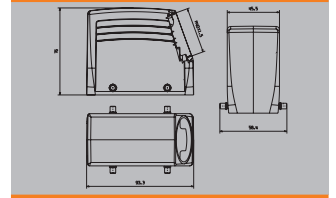

Plug housing, cable entry at top



Version	b (mm)	Type	Order No.
w. thread		HDC 40D TOBU 1M40G EMC	2544040000

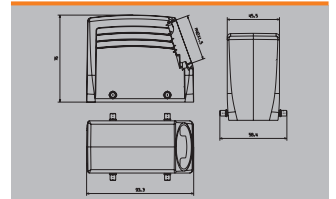

Base

Bulkhead housing



Version	b (mm)	Type	Order No.
Side-locking		HDC 16B ABU EMC	2542320000

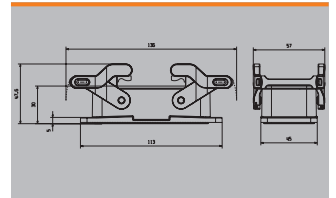

Housing selection RockStar® IP65 EMC

Size 8

Hood

Plug housing, cable entry sideways



Version	b (mm)	Type	Order No.
w. thread		HDC 64D TSBU 1M40G EMC	2544050000

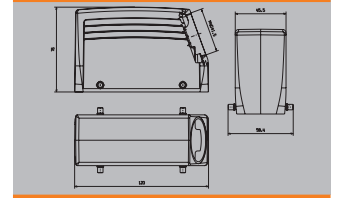

Plug housing, cable entry at top



Version	b (mm)	Type	Order No.
w. thread		HDC 64D TOBU 1M40G EMC	2544060000

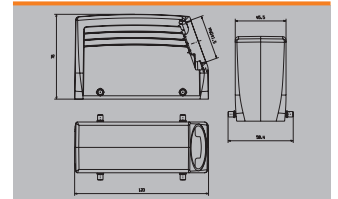

Base

Bulkhead housing



Version	b (mm)	Type	Order No.
Side-locking		HDC 24B ABU EMC	2527810000

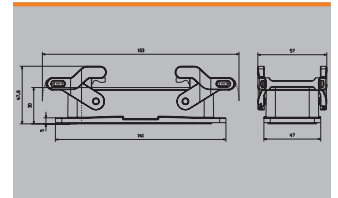

RockStar® Housings IP66 / IP68 / EMC

RockStar® Housings IP66 / IP68 / EMC	Introduction	F.2
	RockStar® Housings IP66 / IP68 / EMC	F.4
	Size 1 - 8	

RockStar® Housings IP66 / IP68 / EMC

The RockStar® IP68 and IP69K housings are resistant to sea water and high impacts. They are designed for use under extreme environmental conditions and comply with the high vibration requirements of DIN EN 61373 Cat 2 (pivot mounting). These housings deliver a fail-safe and maintenance-free solution when using heavy-duty connectors in transportation, traffic engineering and energy technology. They are also suitable for applications subject to extreme climatic conditions.

Weidmüller has designed the RockStar® IP68 housings with additional built-in features that ensure outstanding EMC. The bulkhead or base housing, combined with the plug housing, produces a labyrinth structure which ensures high shield attenuation.

RockStar® IP68 housings are available in sizes 1, 3, 4, 6, 8 and 8 XXL; they can be combined with all fixed-pole and modular inserts.

F



Impact resistant

The optimised construction provides high impact resistance and therefore, a long product lifespan



Practical

Laser labelling for permanent identification and faster allocation

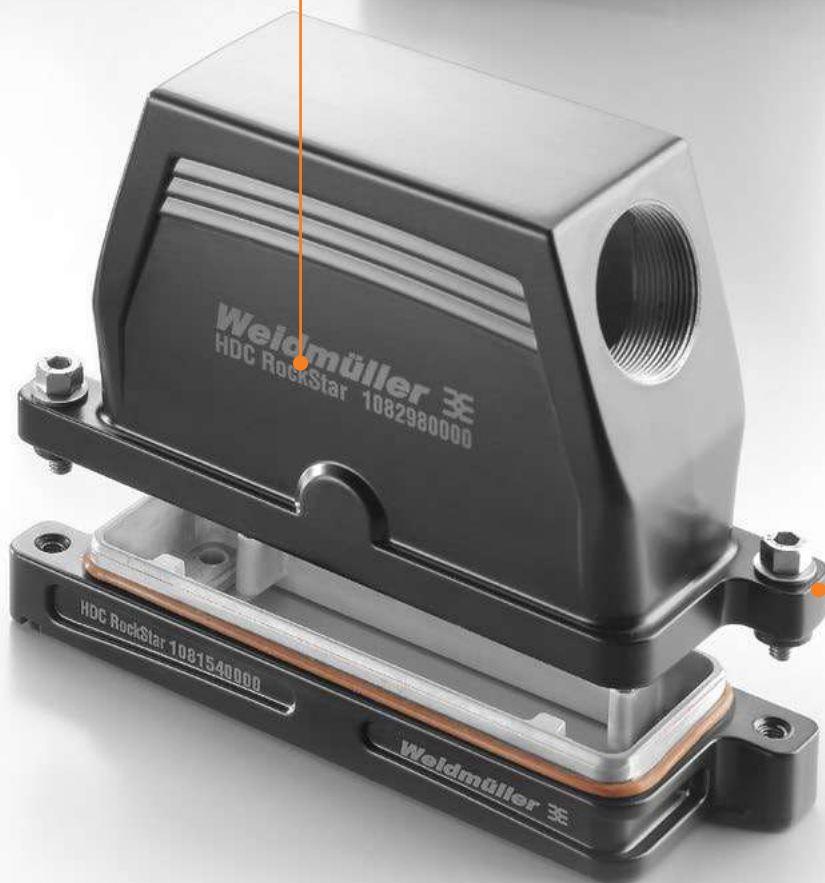
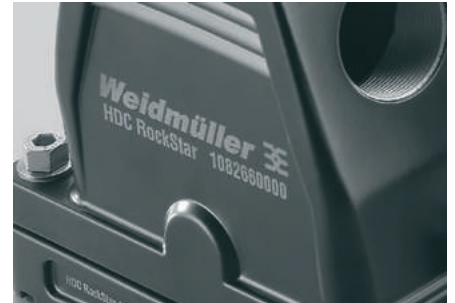

Simple

A screw lock with internal and external hex drive is used for the housing's closure mechanism.



RockStar® Housing IP66 / IP68 / EMC

Screw interlock

Size 1

Hood

Plug housing, cable entry at top



Version	b (mm)	Type	Order No.
w. thread		HDC IP68 04A TOS 1M20	1082390000
w. thread		HDC IP68 04A TOS 1M25G	1513390000
w. thread		HDC IP68 04A TOS 1PG13	1082410000

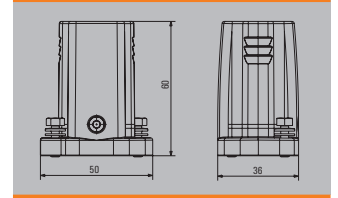

Adapter



Version	b (mm)	Type	Order No.
		HDC IP68 04A ADS	1083130000
w. thread		HDC IP68 04A ADS 1PG13	1083120000

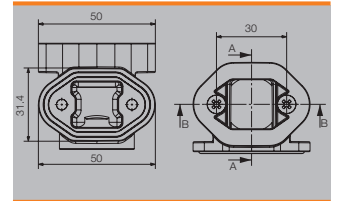

Base

Bulkhead housing



Version	b (mm)	Type	Order No.
		HDC IP68 04A AS	1081470000

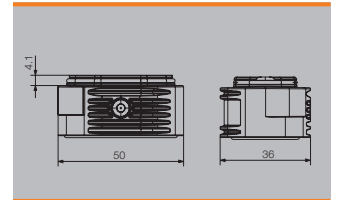

Angled bulkhead housing



Version	b (mm)	Type	Order No.
w. thread		HDC IP68 04A AWS 1M20	1081480000
		HDC IP68 04A AWS	1081490000
w. thread		HDC IP68 04A AWS 1M25	2430170000

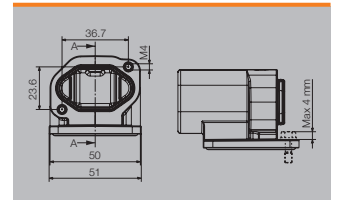

Cover



Version	Type	Order No.
	HDC IP68 04A COVER	1083110000

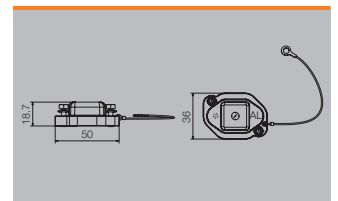

Screw interlock

Size 3

Hood

Plug housing, cable entry sideways



Version	b (mm)	Type	Order No.
w. thread		HDC IP68 06B TSS 1M20	1082510000
w. thread		HDC IP68 06B TSS 1M25	1082530000
w. thread		HDC IP68 06B TSS 1M32	1082550000
w. thread		HDC IP68 06B TSS 1P621	1082570000

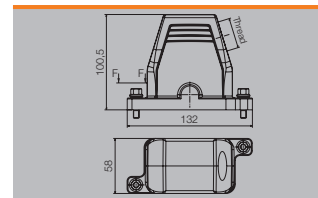

Plug housing, cable entry at top



Version	b (mm)	Type	Order No.
w. thread		HDC IP68 06B TOS 1M20	1082420000
w. thread		HDC IP68 06B TOS 1M25	1082430000
w. thread		HDC IP68 06B TOS 1M32	1082440000
w. thread		HDC IP68 06B TOS 1M40	1082450000
w. thread		HDC IP68 06B TOS 1M32 CS	1288190000

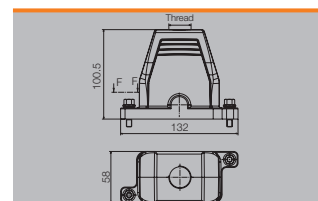

Note Article 1288190000 is mounted with an external earth connection.

Base

Bulkhead housing



Version	b (mm)	Type	Order No.
		HDC IP68 06B AS	1081510000

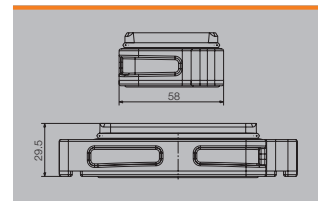

Base housing



Version	b (mm)	Type	Order No.
w. thread		HDC IP68 06B SS 1M20	1081180000
w. thread		HDC IP68 06B SS 2M20	1081250000
w. thread		HDC IP68 06B SS 1M25	1081190000
w. thread		HDC IP68 06B SS 2M25	1081240000
w. thread		HDC IP68 06B SS 1M32	1081210000
w. thread		HDC IP68 06B SS 2M32	1081220000

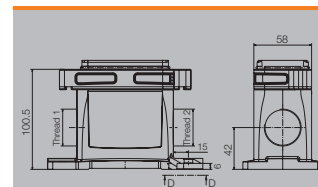

Counter-frame



Version	b (mm)	Type	Order No.
		HDC IP68 06B FRAME M6	1110890000

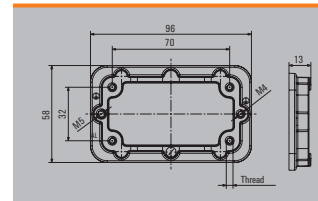

Cover



Version	Type	Order No.
	HDC IP68 06B COVER	1083060000

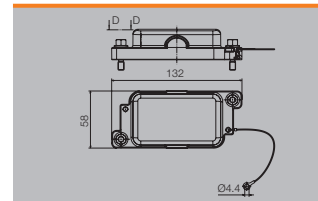

RockStar® Housing IP66 / IP68 / EMC

Screw interlock

Size 4

Hood

Plug housing, cable entry sideways



Version	b (mm)	Type	Order No.
w. thread		HDC IP68 10B TSS 1M20	1082690000
w. thread		HDC IP68 10B TSS 1M25	1082650000
w. thread		HDC IP68 10B TSS 1M32	1082660000
w. thread		HDC IP68 10B TSS 1PG21	1082670000
w. thread		HDC IP68 10B TSS 1PG29	1082680000

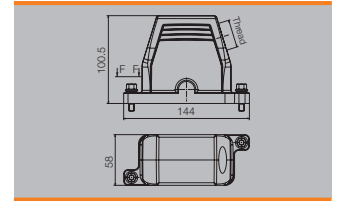

Plug housing, cable entry at top



Version	b (mm)	Type	Order No.
w. thread		HDC IP68 10B TOS 1M20	1082580000
w. thread		HDC IP68 10B TOS 1M25	1082590000
w. thread		HDC IP68 10B TOS 1M32	1082610000
w. thread		HDC IP68 10B TOS 1PG16	1082620000
w. thread		HDC IP68 10B TOS 1PG21	1082630000
w. thread		HDC IP68 10B TOS 1PG29	1082640000

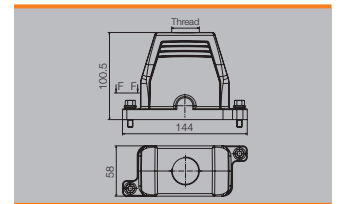

Base

Bulkhead housing



Version	b (mm)	Type	Order No.
		HDC IP68 10B AS	1081520000

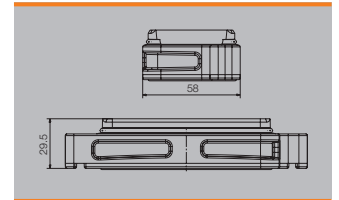

Base housing



Version	b (mm)	Type	Order No.
w. thread		HDC IP68 10B SS 1M20	1081270000
w. thread		HDC IP68 10B SS 1M32	1081280000
w. thread		HDC IP68 10B SS 2M32	1081320000
w. thread		HDC IP68 10B SS 1PG29	1081290000

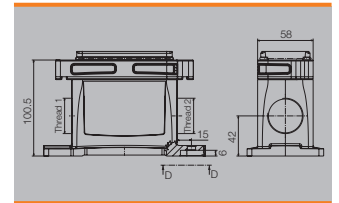

Counter-frame



Version	b (mm)	Type	Order No.
		HDC IP68 10B FRAME M6	1110900000

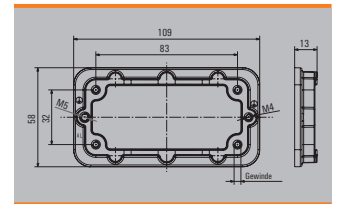

Cover



Version	Type	Order No.
	HDC IP68 10B COVER	1083070000

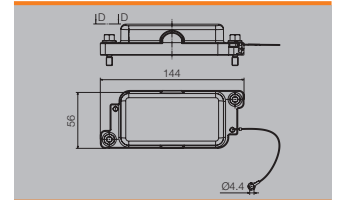

Screw interlock

Size 6

Hood

Plug housing, cable entry sideways



Version	b (mm)	Type	Order No.
w. thread	164	HDC IP68 16B TSS 1M32	1082800000
w. thread	164	HDC IP68 16B TSS 1M40	1082810000
w. thread	164	HDC IP68 16B TSS 1M50	1082820000
w. thread	164	HDC IP68 16B TSS 1PG21	1082830000
w. thread	164	HDC IP68 16B TSS 1PG29	1082840000
w. thread	164	HDC IP68 16B TSS 1PG36	1082850000

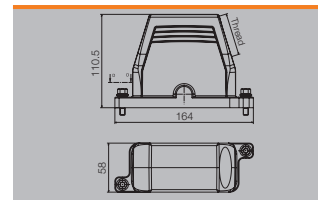

Plug housing, cable entry at top



Version	b (mm)	Type	Order No.
w. thread	164	HDC IP68 16B TOS 1M25	1082700000
w. thread	164	HDC IP68 16B TOS 2M25	1082780000
w. thread	164	HDC IP68 16B TOS 1M32	1082710000
w. thread	164	HDC IP68 16B TOS 1M40	1082720000
w. thread	164	HDC IP68 16B TOS 1M50	1082730000
w. thread	164	HDC IP68 16B TOS 1PG21	1082750000
w. thread	164	HDC IP68 16B TOS 2PG21	1082740000

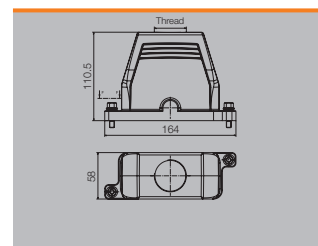

Base

Bulkhead housing



Version	b (mm)	Type	Order No.
	21	HDC IP68 16B AS	1081530000

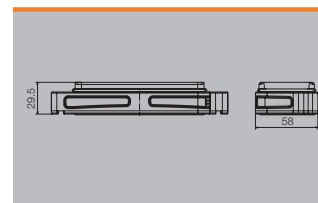

Base housing



Version	b (mm)	Type	Order No.
	111.5	HDC IP68 16B SS	1081340000
w. thread	111.5	HDC IP68 16B SS 1M32	1081350000
w. thread	111.5	HDC IP68 16B SS 2M32	1081390000
w. thread	111.5	HDC IP68 16B SS 1M40	1081360000
w. thread	111.5	HDC IP68 16B SS 2M40	1081370000
w. thread	111.5	HDC IP68 16B SS 1PG36	1081380000

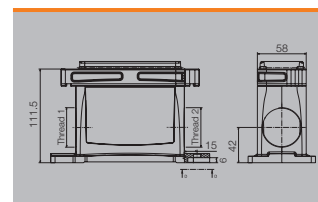

Counter-frame



Version	b (mm)	Type	Order No.
	14	HDC IP68 16B FRAME M6	1110910000

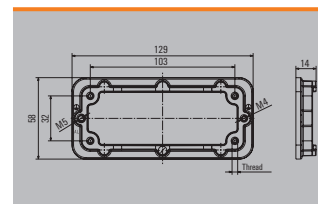

Cover



Version	Type	Order No.
	HDC IP68 16B COVER	1083080000

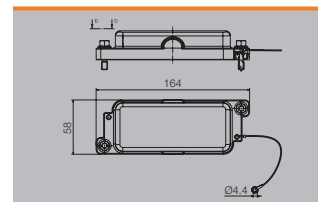

RockStar® Housing IP66 / IP68 / EMC

Screw interlock

Size 8

Hood

Plug housing, cable entry sideways



Version	b (mm)	Type	Order No.
w. thread	110.5	HDC IP68 24B TSS 1M32	1082970000
w. thread	110.5	HDC IP68 24B TSS 1M40	1082980000
w. thread	110.5	HDC IP68 24B TSS 1M50	1082990000
w. thread	110.5	HDC IP68 24B TSS 1PG29	1083000000
w. thread	110.5	HDC IP68 24B TSS 1PG36	1083010000

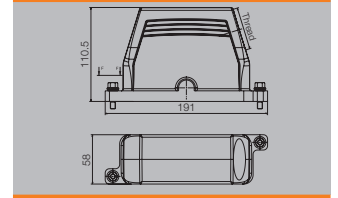

Plug housing, cable entry at top



Version	b (mm)	Type	Order No.
w. thread	110.5	HDC IP68 24B TOS 3M25	1082960000
w. thread	110.5	HDC IP68 24B TOS 1M32	1082860000
w. thread	110.5	HDC IP68 24B TOS 2M32	1082940000
w. thread	110.5	HDC IP68 24B TOS 1M40	1082870000
w. thread	110.5	HDC IP68 24B TOS 2M40	1082950000
w. thread	110.5	HDC IP68 24B TOS 1M50	1082880000
w. thread	110.5	HDC IP68 24B TOS 1PG21	1082900000
w. thread	110.5	HDC IP68 24B TOS 1PG29	1082920000
w. thread	110.5	HDC IP68 24B TOS 2PG29	1082910000
w. thread	110.5	HDC IP68 24B TOS 2M40 TSS 1M32	1289130000

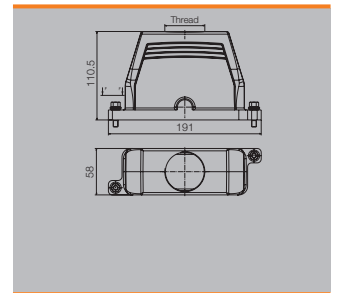

F

Base

Bulkhead housing



Version	b (mm)	Type	Order No.
	29.5	HDC IP68 24B AS	1081540000

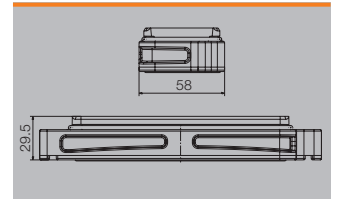

Base housing



Version	b (mm)	Type	Order No.
	111.5	HDC IP68 24B SS	1081450000
w. thread	111.5	HDC IP68 24B SS 1M40	1081410000
w. thread	111.5	HDC IP68 24B SS 2M40	1081420000
w. thread	111.5	HDC IP68 24B SS 1PG36	1081430000

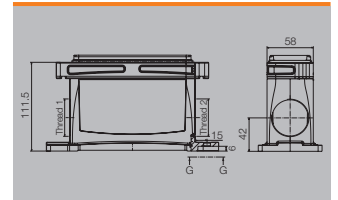

Counter-frame



Version	b (mm)	Type	Order No.
	17	HDC IP68 24B FRAME M6	1110920000

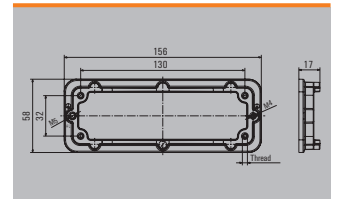

Cover



Version	Type	Order No.
	HDC IP68 24B COVER	1083090000

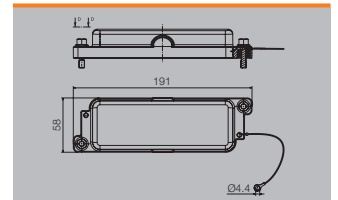

Screw interlock

Size 8, XXL

Hood

Plug housing, cable entry sideways



Version	b (mm)	Type	Order No.
w. thread	120	HDC HB 24 TEK TSS1XM40G	100092000 1
w. thread	120	HDC HB 24 TEK TSS1XM50G	1827160000

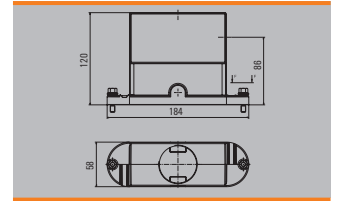

Plug housing, cable entry at top



Version	b (mm)	Type	Order No.
w. thread	120	HDC HB 24 TEK TOS1XM50G	1827170000

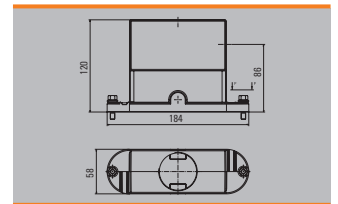

Base

Bulkhead housing



Version	b (mm)	Type	Order No.
	29	HDC HB 24 TEK AS M4	1827470000

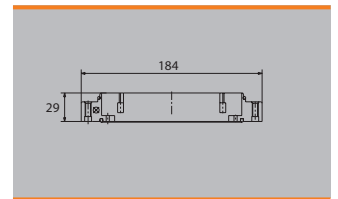

RockStar® Wall mounting housing IP66

RockStar® Wall mounting housing IP66	Introduction	G.2
---	---------------------	-----

RockStar® Wall mounting housing IP66 Size 3, 4, 6 and 8		G.4
---	--	-----

RockStar® Wall mounting housing IP66

Our RockStar® wall mounting housings made of polyamide are used wherever the focus is on weight, robustness and cost-effectiveness. We satisfy these requirements with a light plastic housing with an attached cable gland and screw interlock made of stainless steel. This housing can be connected directly on the panel wall thanks to simple attachment flanges. There is no need for a usual attachment housing.

RockStar® wall mounting housings are available in four sizes and can be combined with all fixed-pole and modular HDC inserts.

Areas of application for our RockStar® wall mounting housings include machinery and plant engineering, the automotive industry, panel building and wind power plants.



Flexible

The housing can be combined with all fixed-pole and modular HDC -RockStar® inserts



Practical

More cost effective thanks to the attached cable gland

**Simple**

The flange-mounted housing seals directly onto the panel wall without an attachment housing



RockStar® Wall mounting housing IP66

Wall mounting housing

Size 3

Hood

Cable entry at top



Version	b (mm)	Type	Order No.
w. cable glands		HDC 06B TOS 1M25 WMP	2716700000

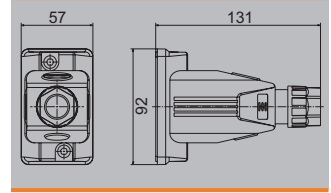

Cable entry sideways



Version	b (mm)	Type	Order No.
w. cable glands		HDC 06B TSS 1M25 WMP	2716750000

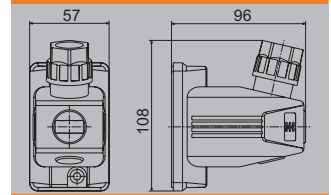

Cover



Version	Type	Order No.
	HDC 06B AF WM COVER	2716810000

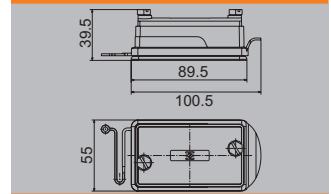

G

Mounting flange



Version	b (mm)	Type	Order No.
		HDC AF WM	2716790000

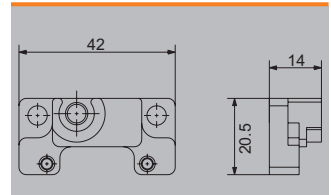

Mounting flange set with screw



Version	b (mm)	Type	Order No.
		HDC AF SET WM	2716800000

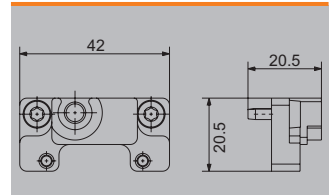

Wall mounting housing

Size 4

Hood

Cable entry at top



Version	b (mm)	Type	Order No.
w. cable glands		HDC 10B TOS 1M32 WMP	2716720000

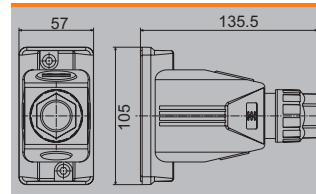

Cable entry sideways



Version	b (mm)	Type	Order No.
w. cable glands		HDC 10B TSS 1M32 WMP	2716760000

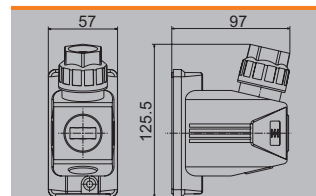

Cover



Version	Type	Order No.
	HDC 10B AF WM COVER	2716820000

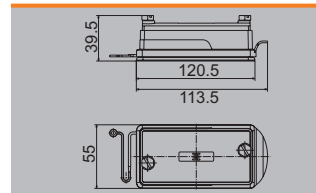

Mounting flange



Version	b (mm)	Type	Order No.
		HDC AF WM	2716790000

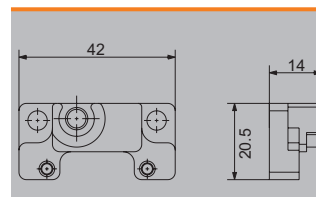

Mounting flange set with screw



Version	b (mm)	Type	Order No.
		HDC AF SET WM	2716800000

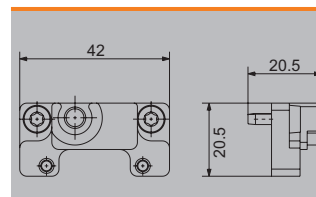

RockStar® Wall mounting housing IP66

Wall mounting housing

Size 6

Hood

Cable entry at top



Version	b (mm)	Type	Order No.
w. cable glands		HDC 16B TOS 1M40 WMP	2716730000

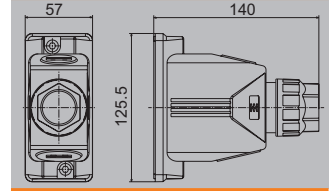

Cable entry sideways



Version	b (mm)	Type	Order No.
w. cable glands		HDC 16B TSS 1M40 WMP	2716770000

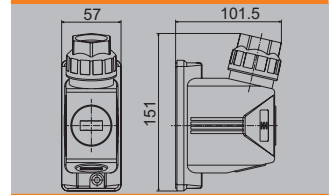

Cover



Version	Type	Order No.
	HDC 16B AF WM COVER	2716830000

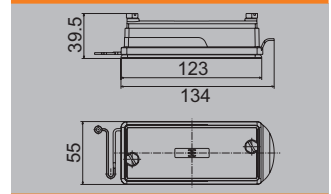

Mounting flange



Version	b (mm)	Type	Order No.
		HDC AF WM	2716790000

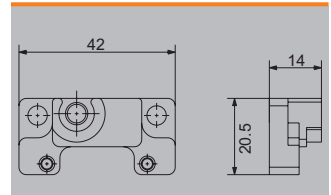

Mounting flange set with screw



Version	b (mm)	Type	Order No.
		HDC AF SET WM	2716800000

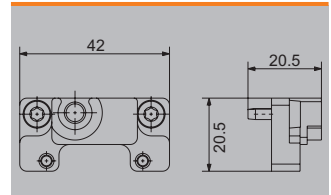

Wall mounting housing

Size 8

Hood

Cable entry at top



Version	b (mm)	Type	Order No.
w. cable glands		HDC 24B TOS 1M40 WMP	2716740000

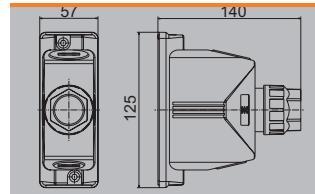

Cable entry sideways



Version	b (mm)	Type	Order No.
w. cable glands		HDC 24B TSS 1M40 WMP	2716780000

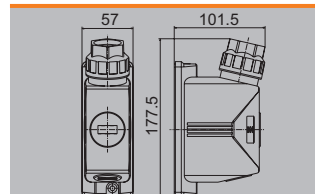

Cover



Version	Type	Order No.
	HDC 24B AF WM COVER	2716840000

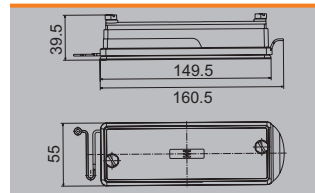

Mounting flange



Version	b (mm)	Type	Order No.
		HDC AF WM	2716790000

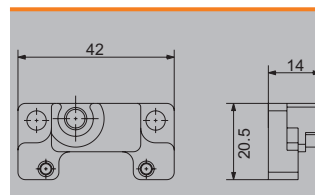

Mounting flange set with screw



Version	b (mm)	Type	Order No.
		HDC AF SET WM	2716800000

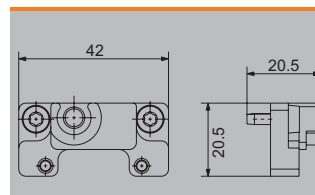

RockStar® HighPower

RockStar® HighPower	Introduction	H.2
	RockStar® HighPower 250 A	H.4
	4,000 V	
	250 A	
	1 - 4 poles	
	RockStar® HighPower 550 A	H.10
	4,000 V	
	550 A	
	1 - 3 poles	

RockStar® HighPower

Uncompromising power – in clever and safe packaging. The RockStar® HighPower modular high-current connector system has been custom designed for the high demands of traffic engineering applications. The system also meets the requirements of the wind power industry. The modular set-up consists of one-piece crimp contacts, insulating sleeves, insert-holder frames and a robust multi-part die-cast aluminium enclosure in IP68, as well as cross-connection options.

This modular design offers clear advantages for handling: It is possible to wire crimped lines with large cross-sections and to see this process through to the final step. The wiring can be achieved using standard cable glands.

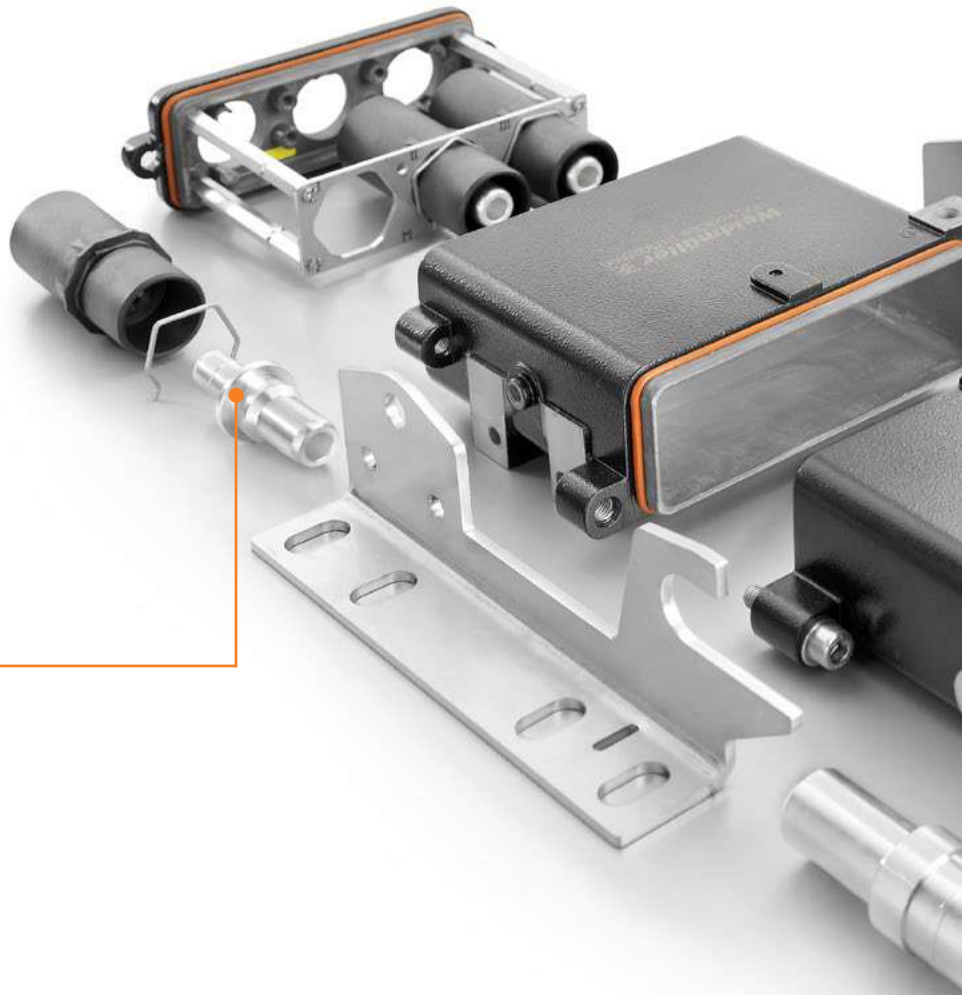

Safe

Tried-and-tested, low-maintenance crimp-connection technology with stranded, finely stranded and very finely stranded flexible copper conductors measuring up to 240 mm² with standardised tools



Practical and universal

A multitude of potential applications have been made pluggable for the first time ever – simply by integrating cross-connections.

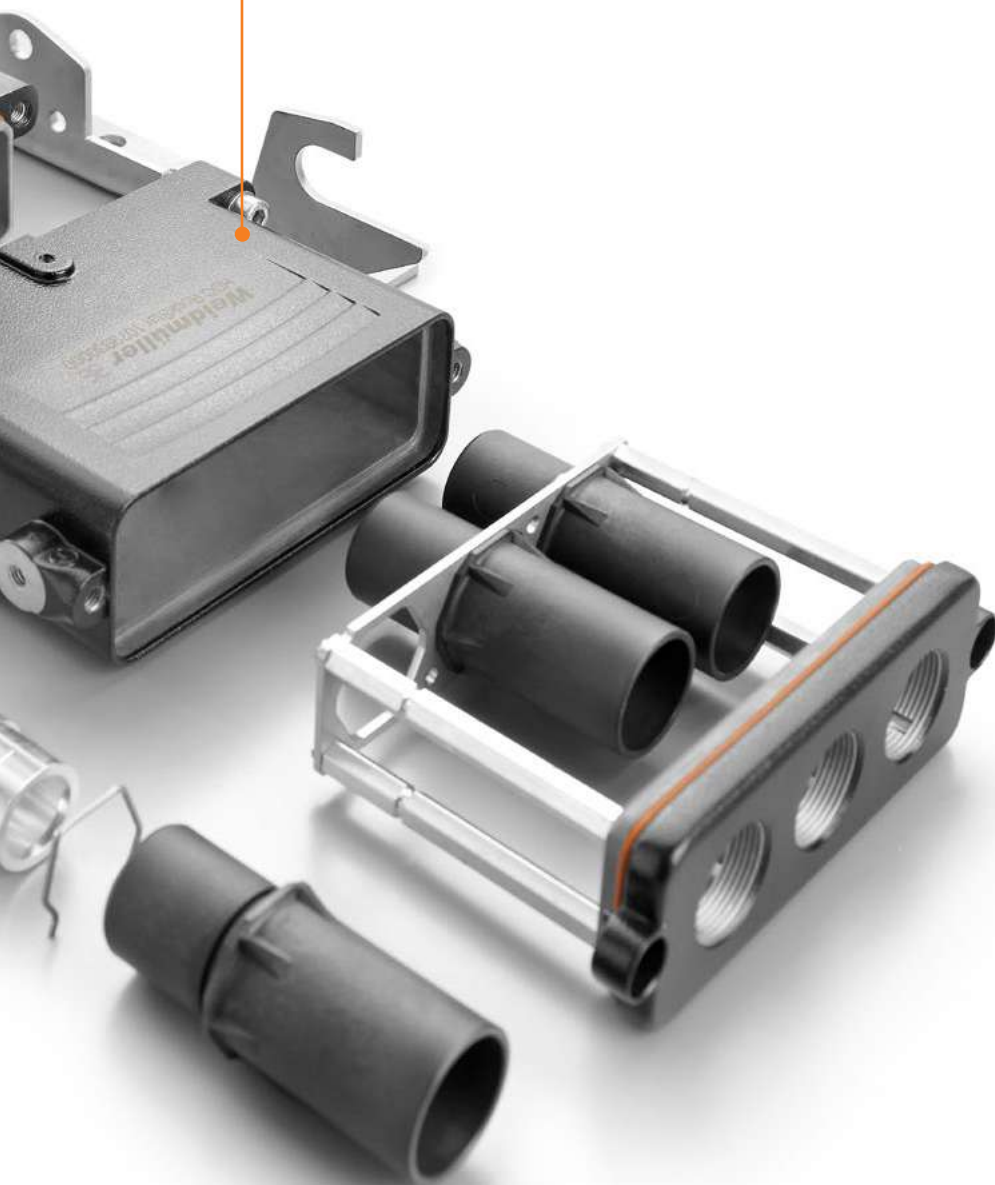
**Perfectly optimised shielding**

Along with the 360° contact, the shielding connection integrated in the enclosure is the cutting edge of what is technically feasible at present.



HighPower 250 A

RockStar® HighPower is designed to meet the strict standards set by DIN EN 61373 Cat. 2 (pivot mounting). The coordinated connector components provide you with a fail-safe and maintenance-free power transmission solution: in this case up to 250 A / 4,000 V.



Technical data

HighPower 250 A series	
Standards	DIN EN 50124-1 In compliance with DIN EN 61984 DIN EN 50155 DIN EN 61373 KAT 2 (Pivot mounting)
Number of contacts	1-, 2-, 3-, 4 poles
Wire connection method	Crimp
Rated current	250 A
Rated insulation voltage (highest permitted operating voltage)	
AC wire - wire	4,000 V (4,800 V)*
AC wire - earthed housing	2,300 V (3,000 V)*
DC wire - wire	4,000 V (4,800 V)*
DC wire - earthed housing	2,300 V (3,000 V)*
Rated impulse voltage	
Wire - wire	25 kV
Wire - earthed housing	15 kV
Surge voltage category	OV 3
Pollution severity degree	PD 2 (PD 3) ¹
Material	
Insulating body	PA 66 glass-fibre reinforced
Contact	Copper alloy, silver plated
Flammability	
According to UL 94	V-0
According to NFF 16-101 / NFF 16-102	I3 F2
EN45545 Part 2	R22, R23 HL3
Insulation resistance	10 ¹⁰ Ω
Temperature range	-55 °C to +120 °C
HDC IP68 HP 248 series	
Protection degree according to DIN EN 60529	IP68 when interlocked
Colour	RAL 9005 (black)
Surface finish	Powder coating
Locking element	
Screw interlock	M8
Material	Stainless steel, rust-proof
Torque	11 Nm
Housing seal	Silicone rubber
Temperature range	-50 °C to +120 °C
Material	
Housing	Die-cast aluminium alloy, corrosion resistant
Mounting bracket	Stainless steel, rust-proof
Accessories	
Material	
Assembly frame	Stainless steel, rust-proof
Touch-safe protection	PA66
Colour	
Assembly frame	Natural
Touch-safe protection	Orange
Cable gland	
Material	
Cable gland	Optional as nickel-plated brass or stainless steel
Seal insert	TPE T80s
Temperature range	-40 °C to +130 °C
Class of protection	IP68
Note:	
*4,800 V, depending on the application	
*1 The contacts are protected against contamination and condensation within the HDC housing.	
The completely assembled connector can be used at pollution degree PD 3.	

Overview

	Size	Rated voltage	Rated current	No. of poles	Tension clamp connection	TOP connection	Screw conn. with wire guard spring	Crimp connection	PUSH IN connection	Page
	8	4,000 V	250 A	1 - 4				•		H.6

RockStar® HighPower 250 A

Crimp contacts

Crimp contact



Conductor cross-section	Pin Type	Order No.	Female Type	Order No.
25 mm ²	HDC HP 250 M 25	1079690000	HDC HP 250 F 25	1079720000
35 mm ²	HDC HP 250 M 35	1079680000	HDC HP 250 F 35	1079730000
50 mm ²	HDC HP 250 M 50	1119080000	HDC HP 250 F 50	1079740000
70 mm ²	HDC HP 250 M 70	1119090000	HDC HP 250 F 70	1079750000
95 mm ²	HDC HP 250 M 95	1119100000	HDC HP 250 F 95	1079770000
Insulated PE contact				
50 mm ²	HDC HP 250 M 50 PE	1220850000	HDC HP 250 F 50 PE	1220840000

Note In the version described here, the crimp contacts can be used for crimp connections with flexible, stranded, and finely stranded copper wires (according to DIN 48201 part 1 and DIN 57 295 VDE 0295) or with crimping inserts (according to DIN 48083 part 1, part 3 and part 4). We would be glad to customise the crimp contact to fit your requirements.

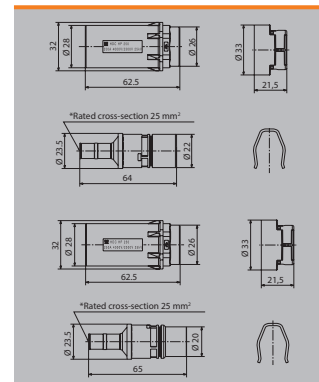

Housing

Plug housing



Version	Type	Order No.
Plug	HDC IP68 HP 24B T0	1079930000

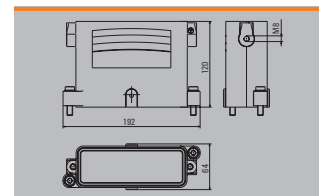

Base housing



Version	Type	Order No.
Base housing	HDC IP68 HP 24B AS S	1079920000

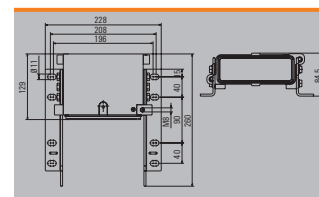

Bulkhead housing



Version	Type	Order No.
Bulkhead (feed-through)	HDC IP68 HP 24B A	1120040000

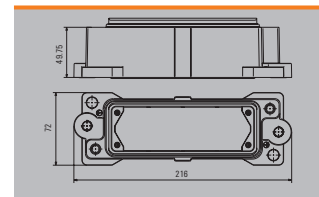

Counter-frame



Version	Type	Order No.
Counter-frame	HDC IP68 24B HP FRAME	1282820000

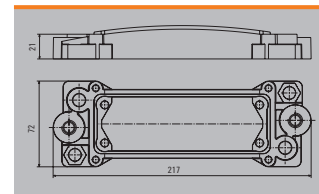

Cover for base & bulkhead



Version	Type	Order No.
	HDC IP68 24B COVER CS	1324500000



RockStar® HighPower 250 A

Housing

Mounting cover



Version	Cable entry	Number	Size	Type	Order No.
Cover				HDC IP68 24B MD	1119950000
Cover	w. threading	3	M 40	HDC IP68 24B MD 3M40	1119970000
Cover	w. threading	3	M 32	HDC IP68 24B MD 3M32	1119980000
Cover	w. threading	3	M 25	HDC IP68 24B MD 3M25	1079910000
Cover	w. threading	2	M 40	HDC IP68 24B MD 2M40	1119990000
Cover	w. threading	2	M 32	HDC IP68 24B MD 2M32	1120000000
Cover	w. threading	4	M 25	HDC IP68 24B MD 4M25 T1	1160450000
Cover	w. threading	2	M 25	HDC IP68 24B MD 2M25	1120010000
Cover	w. threading	4	M 25	HDC IP68 24B MD 4M25 T2	1220860000
Cover	w. threading	1	M 50	HDC IP68 HP 24B 1M50	2451460000
Cover	w. threading	1	M 63	HDC IP68 HP 24B 1M63	2473940000

Note Because of the asymmetric arrangement of the four threaded holes, the T1 version must be used on one side and the T2 version must be used on the other side.

Accessories

Mounting frame



Size	Number of poles	Type	Order No.
3	1	HDC 06B HP250 MPL1	1103680000
8	2	HDC 24B HP250 MPL2 TYP1	1103690000
8	2	HDC 24B HP250 MPL2 TYP2	1103740000
8	3	HDC 24B HP250 MPL3 TYP1	1079640000
8	3	HDC 24B HP250 MPL3 TYP2	1103750000
8	4	HDC 24B HP250 MPL4 TYP1	1160430000
8	4	HDC 24B HP250 MPL4 TYP2	1160440000
8	4	HDC 24B HP250 MPL4PE T1	1212890000
8	4	HDC 24B HP250 MPL4PE T2	1212910000

Note TYP1 = Female, TYP 2 = Male

Mounting frame set



Size	Number of poles	Type	Order No.
8	3	HDC HP 250 SSF B0 SET	2008220000
8	3	HDC HP 250 SSM B0 SET	2008210000

Note Low resistance current transmission

Cable glands



Thread	Material	Cable diameter	Type	Order No.
M 25	Brass, nickel-plated	11...20 mm	VGM25-MS68 11-20 BG	1193600000
M 32	Brass, nickel-plated	15...25 mm	VGM32-MS68 15-25 BG	1193610000
M 40	Brass, nickel-plated	20...32 mm	VGM40-MS68 20-32 BG	1193620000
M 25	Stainless steel 1.4305 (303)	11...20 mm	VGM25-SS68 11-20 BG	1193570000
M 32	Stainless steel 1.4305 (303)	15...25 mm	VGM32-SS68 15-25 BG	1193580000
M 40	Stainless steel 1.4305 (303)	20...32 mm	VGM40-SS68 20-32 BG	1193590000

Note When using mounting covers with 3 X M 40 cable input threads, the elongated version must be used for the cable gland in the middle. Installation specifications and tightening torques can be found in the installation instructions. For further information please use our online catalogue: catalog.weidmueller.com

Cable glands, elongated version



Thread	Material	Cable diameter	Type	Order No.
M 40	Stainless steel 1.4305 (303)	20...32 mm	VGM40/1-SS68 20-32 BG	1205920000
M 40	Brass, nickel-plated	20...32 mm	VGM40/1-MS68 20-32 BG	1205890000

RockStar® HighPower 250 A

Accessories

EMC shield connection



Version	Type	Order No.
	VGM25-MS68 EMC 11-20SET	1463720000
	VGM32-MS68 EMC 15-25SET	1463730000
	VGM40-MS68 EMC 20-32SET	2457660000
	VGM40L-MS68EMC 20-32SET	2498320000

Note Installation specifications and tightening torques can be found in the installation instructions. For further information please use our online catalogue: catalog.weidmueller.com.

Mounting tool



Version	Type	Order No.
	HDC FBS TOOL 13-50	8000015137

Note Spring band clamp installation tool for HighPower shield connections

Touch-safe protection set



Version	Type	Order No.
	HDC HP 250 SHOCKPROTEC	1120130000

Note For use with HighPower 250 A female contacts

Signal contact carrier



Version	Type	Order No.
Pin	HDC HP 250 M CM3	1415410000
Female	HDC HP 250 F CM3	1415420000

Note The CM3 crimp contacts have to be ordered separately.

Crimping tools

EPG 45 hydraulic battery crimping tool



Type	Order No.
EPG 45	1500830000

Hexagonal crimp inserts for EPG 45



Code no.	CU mm ²	Crimping width	Type	Order No.
5	6	7	ES EPG 45 HEX 6	1500930000
6/16	10/70	7/5	ES EPG 45 HEX 10/70	1500940000
8/12	16/35	12/10	ES EPG 45 HEX 16/35	1500950000
10/14	25/50	12/5	ES EPG 45 HEX 25/50	1500970000
18	95	5	ES EPG 45 HEX 95	1500980000
20	120	5	ES EPG 45 HEX 120	1500990000
22	150	5	ES EPG 45 HEX 150	1994540000

RockStar® HighPower 250 A

Crimping tools

APG 80 hydraulic battery crimping tool



Type	Order No.
APG 80	1502390000

Hexagonal crimp inserts for APG 80



Code no.	CU mm ²	Crimping width	Type	Order No.
5	6	7	ES APG 80 HEX 6	1502600000
6	10	7	ES APG 80 HEX 10	1502620000
8	16	12	ES APG 80 HEX 16	1502630000
10	25	12	ES APG 80 HEX 25	1502640000
12	35	12	ES APG 80 HEX 35	1502650000
14	50	12	ES APG 80 HEX 50	1502670000
16	70	12	ES APG 80 HEX 70	1502680000
18	95	10	ES APG 80 HEX 95	1502690000
20	120	10	ES APG 80 HEX 120	1502700000
22	150	5	ES APG 80 HEX 150	1502720000
25	185	5	ES APG 80 HEX 185	1502730000
28	240	5	ES APG 80 HEX 240	1502740000
32	300	7	ES APG 80 HEX 300	1502750000

HighPower 550 A

RockStar® HighPower is designed to meet the strict standards set by DIN EN 61373 Cat. 2 (pivot mounting). The coordinated connector components provide you with a fail-safe and maintenance-free power transmission solution: in this case up to 550 A / 4,000 V.



Technical data

HighPower 550 A series	
Standards	DIN EN 50124-1 In compliance with DIN EN 61984 DIN EN 50155 DIN EN 61373 KAT 2 (Pivot mounting)
Number of contacts	1-, 2-, 3 poles
Wire connection method	Crimp
Rated current	550 A
Rated insulation voltage (highest permitted operating voltage)	
AC wire - wire	4,000 V (4,800 V)*
AC wire - earthed housing	3,000 V
DC wire - wire	4,000 V (4,800 V)*
DC wire - earthed housing	3,000 V
Rated impulse voltage	
Wire - wire	25 kV
Wire - earthed housing	15 kV
Surge voltage category	OV 3
Pollution severity degree	PD 2 (PD 3) ¹
Material	
Insulating body	PA 66 glass-fibre reinforced
Contact	Copper alloy, silver plated
Flammability	
According to UL 94	V-0
According to NFF 16-101 / NFF 16-102	I3 F2
Insulation resistance	10 ¹⁰ Ω
Temperature range	-55 °C to +120 °C
HDC IP68 HP 24B series	
Protection degree according to DIN EN 60529	IP68 when interlocked
Colour	RAL 9005 (black)
Surface finish	Powder coating
Locking element	
Screw interlock	M8
Material	Stainless steel, rust-proof
Torque	11 Nm
Housing seal	Silicone rubber
Temperature range	-50 °C to +120 °C
Material	
Housing	Die-cast aluminium alloy, corrosion resistant
Mounting bracket	Stainless steel, rust-proof
Accessories	
Material	
Assembly frame	Stainless steel, rust-proof
Touch-safe protection	PA66
Colour	
Assembly frame	Natural
Touch-safe protection	Orange
Cable gland	
Material	
Cable gland	Optional as nickel-plated brass or stainless steel
Seal insert	TPE T80s
Temperature range	-40 °C to +130 °C
Class of protection	IP68
Note:	
*4,800 V, depending on the application	
*1 The contacts are protected against contamination and condensation within the HDC housing.	
The completely assembled connector can be used at pollution degree PD 3.	

Overview

	Size	Rated voltage	Rated current	No. of poles	Tension clamp connection	TOP connection	Screw conn. with wire guard spring	Crimp connection	PUSH IN connection	Page
	8	4,000 V	550 A	1 - 3				•		H.12

Crimp contacts

Crimp contact



Conductor cross-section	Pin Type	Order No.	Female Type	Order No.
25 mm ²	HDC HP 550 M 25	1220580000	HDC HP 550 F 25	1220570000
50 mm ²	HDC HP 550 M 50	1157800000	HDC HP 550 F 50	1177100000
70 mm ²	HDC HP 550 M 70	1268810000	HDC HP 550 F 70	1268820000
95 mm ²	HDC HP 550 M 95	1079790000	HDC HP 550 F 95	1079810000
120 mm ²	HDC HP 550 M 120	1079780000	HDC HP 550 F 120	1079820000
150 mm ²	HDC HP 550 M 150	1119110000	HDC HP 550 F 150	1079830000
185 mm ²	HDC HP 550 M 185	1120580000	HDC HP 550 F 185	1079840000
240 mm ²	HDC HP 550 M 240	1120590000	HDC HP 550 F 240	1120600000

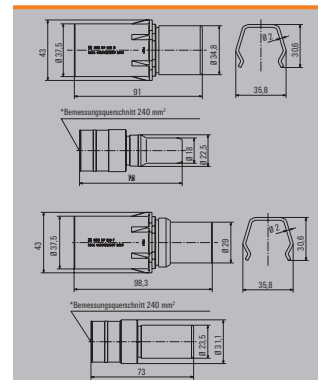

Housing

Plug housing



Version	Type	Order No.
Plug	HDC IP68 HP 24B T0	1079930000

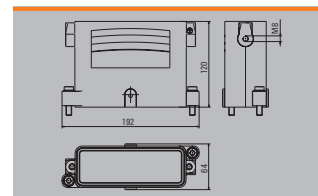

Base housing



Version	Type	Order No.
Base housing	HDC IP68 HP 24B AS S	1079920000

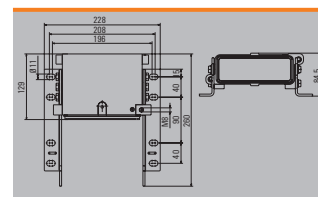

Bulkhead housing



Version	Type	Order No.
Bulkhead (feed-through)	HDC IP68 HP 24B A	1120040000

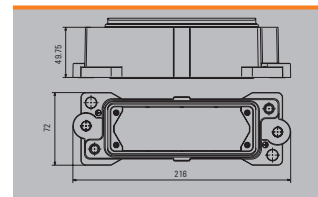

Counter-frame



Version	Type	Order No.
Counter-frame	HDC IP68 24B HP FRAME	1282820000

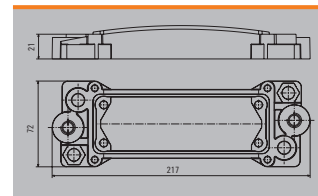

Cover for base & bulkhead



Version	Type	Order No.
	HDC IP68 24B COVER CS	1324500000



RockStar® HighPower 550 A

Housing

Mounting cover



Version	Cable entry	Number	Size	Type	Order No.
Cover				HDC IP68 24B MD	1119950000
Cover	w. threading	3	M 40	HDC IP68 24B MD 3M40	1119970000
Cover	w. threading	3	M 32	HDC IP68 24B MD 3M32	1119980000
Cover	w. threading	3	M 25	HDC IP68 24B MD 3M25	1079910000
Cover	w. threading	2	M 40	HDC IP68 24B MD 2M40	1119990000
Cover	w. threading	2	M 32	HDC IP68 24B MD 2M32	1120000000
Cover	w. threading	2	M 25	HDC IP68 24B MD 2M25	1120010000
Cover	w. threading	1	M 50	HDC IP68 HP 24B 1M50	2451460000
Cover	w. threading	1	M 63	HDC IP68 HP 24B 1M63	2473940000

Note Because of the asymmetric arrangement of the four threaded holes, the T1 version must be used on one side and the T2 version must be used on the other side.

Accessories

Mounting frame



Size	Number of poles	Type	Order No.
8	2	HDC 24B HP550 MPL2 TYP1	1103710000
8	2	HDC 24B HP550 MPL2 TYP2	1103770000
8	3	HDC 24B HP550 MPL3 TYP1	1103720000
8	3	HDC 24B HP550 MPL3 TYP2	1103780000

Note TYP1 = Female, TYP2 = Male

Mounting frame set



Size	Number of poles	Type	Order No.
8	3	HDC HP 550 SSM SET	1987920000
8	3	HDC HP 550 SSF SET	1987950000

Note Low resistance screen transmission

Cable gland



Thread	Material	Cable diameter	Type	Order No.
M 25	Brass, nickel-plated	11...20 mm	VGM25-MS68 11-20 BG	1193600000
M 32	Brass, nickel-plated	15...25 mm	VGM32-MS68 15-25 BG	1193610000
M 40	Brass, nickel-plated	20...32 mm	VGM40-MS68 20-32 BG	1193620000
M 25	Stainless steel 1.4305 (303)	11...20 mm	VGM25-SS68 11-20 BG	1193570000
M 32	Stainless steel 1.4305 (303)	15...25 mm	VGM32-SS68 15-25 BG	1193580000
M 40	Stainless steel 1.4305 (303)	20...32 mm	VGM40-SS68 20-32 BG	1193590000

Note When using mounting covers with 3 X M 40 cable input threads, the elongated version must be used for the cable gland in the middle. Installation specifications and tightening torques can be found in the installation instructions. For further information please use our online catalogue: catalog.weidmueller.com

EMC shield connection



Version	Type	Order No.
	VGM25-MS68 EMC 11-20SET	1463720000
	VGM32-MS68 EMC 15-25SET	1463730000
	VGM40-MS68 EMC 20-32SET	2457660000
	VGM40L-MS68EMC 20-32SET	2498320000

Note Installation specifications and tightening torques can be found in the installation instructions. For further information please use our online catalogue: catalog.weidmueller.com.

Mounting tool



Version	Type	Order No.
	HDC FBS TOOL 13-50	8000015137

Note Spring band clamp installation tool for HighPower shield connections

RockStar® HighPower

RockStar® HighPower 550 A

Touch-safe protection set



Version	Type	Order No.
	HDC HP 550 SHOCKPROTEC	1120140000

Note For use with HighPower 550 A female contacts

Coding pin



Version	Type	Order No.
	HDC HP CODING SYSTEM	1160780000

RockStar® HighPower 550 A

Crimp contacts

Crimp contact



Conductor cross-section	Pin Type	Order No.	Female Type	Order No.
25 mm ²	HDC HP 550 M 25	1220580000	HDC HP 550 F 25	1220570000
50 mm ²	HDC HP 550 M 50	1157800000	HDC HP 550 F 50	1177100000
70 mm ²	HDC HP 550 M 70	1268810000	HDC HP 550 F 70	1268820000
95 mm ²	HDC HP 550 M 95	1079790000	HDC HP 550 F 95	1079810000
120 mm ²	HDC HP 550 M 120	1079780000	HDC HP 550 F 120	1079820000
150 mm ²	HDC HP 550 M 150	1119110000	HDC HP 550 F 150	1079830000
185 mm ²	HDC HP 550 M 185	1120580000	HDC HP 550 F 185	1079840000
240 mm ²	HDC HP 550 M 240	1120590000	HDC HP 550 F 240	1120600000

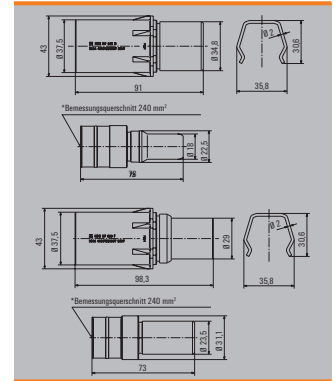

Housing

Plug housing



Version	Type	Order No.
	HDC HP550 STGH CR 1P	2568600000

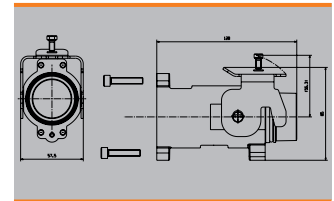

Bulkhead housing



Version	Type	Order No.
	HDC HP550 ABGH CR 1P	2568530000

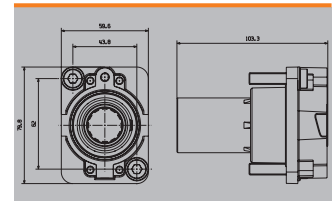

Backpanel



Version	Type	Order No.
	HDC HP550 ABGR CR 1P M20	2599940000
	HDC HP550 ABGR CR 1P M25	2599930000
	HDC HP550 ABGR CR 1P M32	2599920000
	HDC HP550 ABGR CR 1P M40	2599910000
	HDC HP550 ABGR CR 1P PG36	2568560000

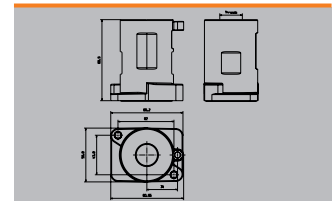

Threaded cover / cable inlet adapter



Version	Cable entry	Number	Size	Type	Order No.
				HDC HP550 GHDE CR 1P M20	2599840000
				HDC HP550 GHDE CR 1P M25	2599810000
				HDC HP550 GHDE CR 1P M32	2599790000
				HDC HP550 GHDE CR 1P M40	2599770000
				HDC HP550 GHDE CR 1P PG36	2568630000

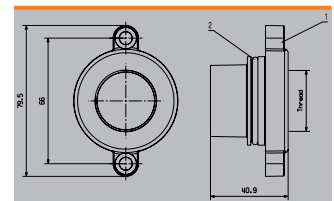

Accessories

Touch-safe protection set



Version	Type	Order No.
	HDC HP 550 SHOCKPROTEC	1120140000

Note For use with HighPower 550 A female contacts



RockStar® HighPower 550 A

Crimping tools

EPG 45 hydraulic battery crimping tool



Type	Order No.
EPG 45	1500830000

Hexagonal crimp inserts for EPG 45



Code no.	CU mm ²	Crimping width	Type	Order No.
5	6	7	ES EPG 45 HEX 6	1500930000
6/16	10/70	7/5	ES EPG 45 HEX 10/70	1500940000
8/12	16/35	12/10	ES EPG 45 HEX 16/35	1500950000
10/14	25/50	12/5	ES EPG 45 HEX 25/50	1500970000
18	95	5	ES EPG 45 HEX 95	1500980000
20	120	5	ES EPG 45 HEX 120	1500990000
22	150	5	ES EPG 45 HEX 150	1994540000

APG 80 hydraulic battery crimping tool



Type	Order No.
APG 80	1502390000

Hexagonal crimp inserts for APG 80



Code no.	CU mm ²	Crimping width	Type	Order No.
5	6	7	ES APG 80 HEX 6	1502600000
6	10	7	ES APG 80 HEX 10	1502620000
8	16	12	ES APG 80 HEX 16	1502630000
10	25	12	ES APG 80 HEX 25	1502640000
12	35	12	ES APG 80 HEX 35	1502650000
14	50	12	ES APG 80 HEX 50	1502670000
16	70	12	ES APG 80 HEX 70	1502680000
18	95	10	ES APG 80 HEX 95	1502690000
20	120	10	ES APG 80 HEX 120	1502700000
22	150	5	ES APG 80 HEX 150	1502720000
25	185	5	ES APG 80 HEX 185	1502730000
28	240	5	ES APG 80 HEX 240	1502740000
32	300	7	ES APG 80 HEX 300	1502750000

RockStar® Kits

RockStar® Kits	Introduction	1.2
	RockStar® Kits with HA inserts	1.4
	400 V	
	16 A	
	3 - 4 poles	
	RockStar® Kits with HE inserts	1.8
	500 V	
	16 A	
	6 - 48 poles	
	RockStar® Kits with HSB inserts	1.28
	400 V	
	35 A	
	6 poles	

RockStar® Kits

RockStar® kits are sets consisting of all components necessary for assembling a heavy-duty connector. The kit includes the male and female inserts, the plug housing, the bulkhead housing and the cable gland.

The benefits for you:

- Easy to purchase – only one ordered part for all items
- Easy to use – just one package with no individual parts
- Wide variety – we'll put together a customised kit for whichever components you need.

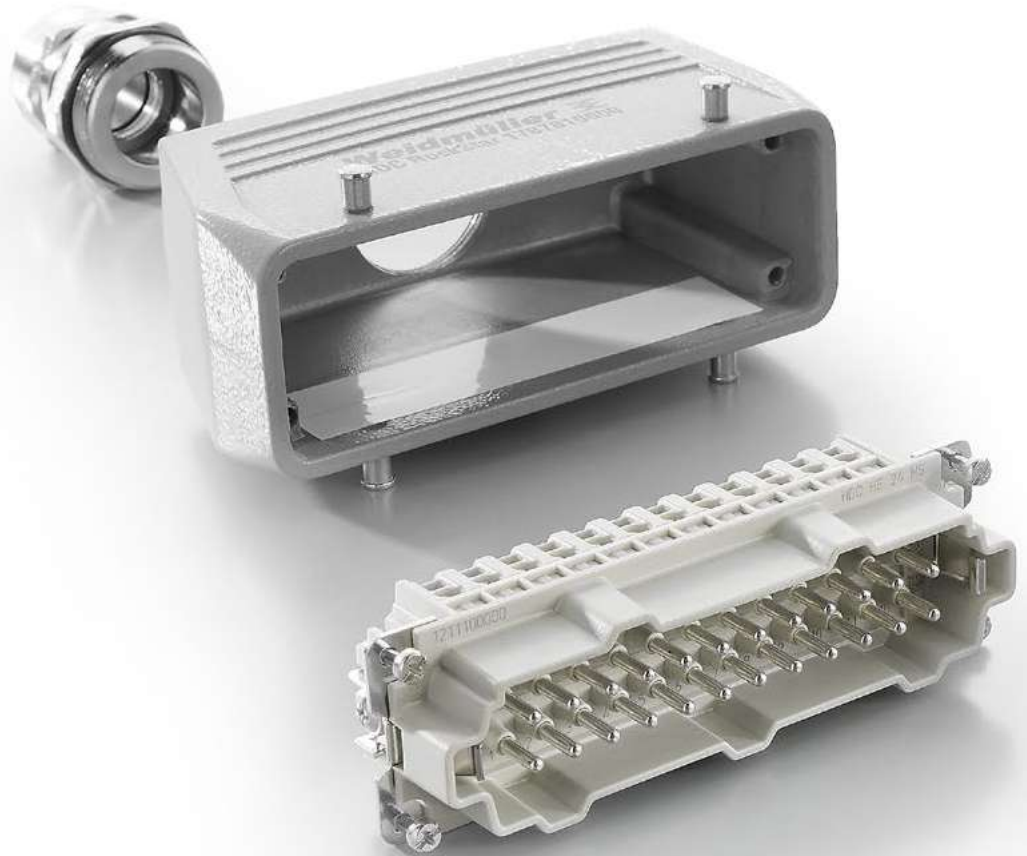

Easy to choose

All components at a single glance – each matched to the required number of poles, size and wire connection method



Easy to stock

Only one package is needed for the complete connector. The RockStar® kits simplify your logistics.

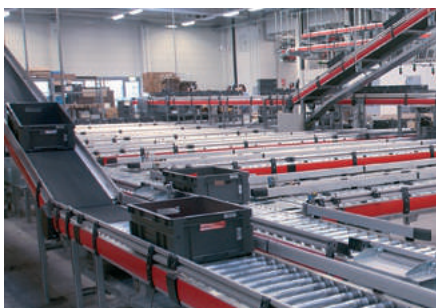

Easy to install

You only need a screwdriver to install the connector in the field.

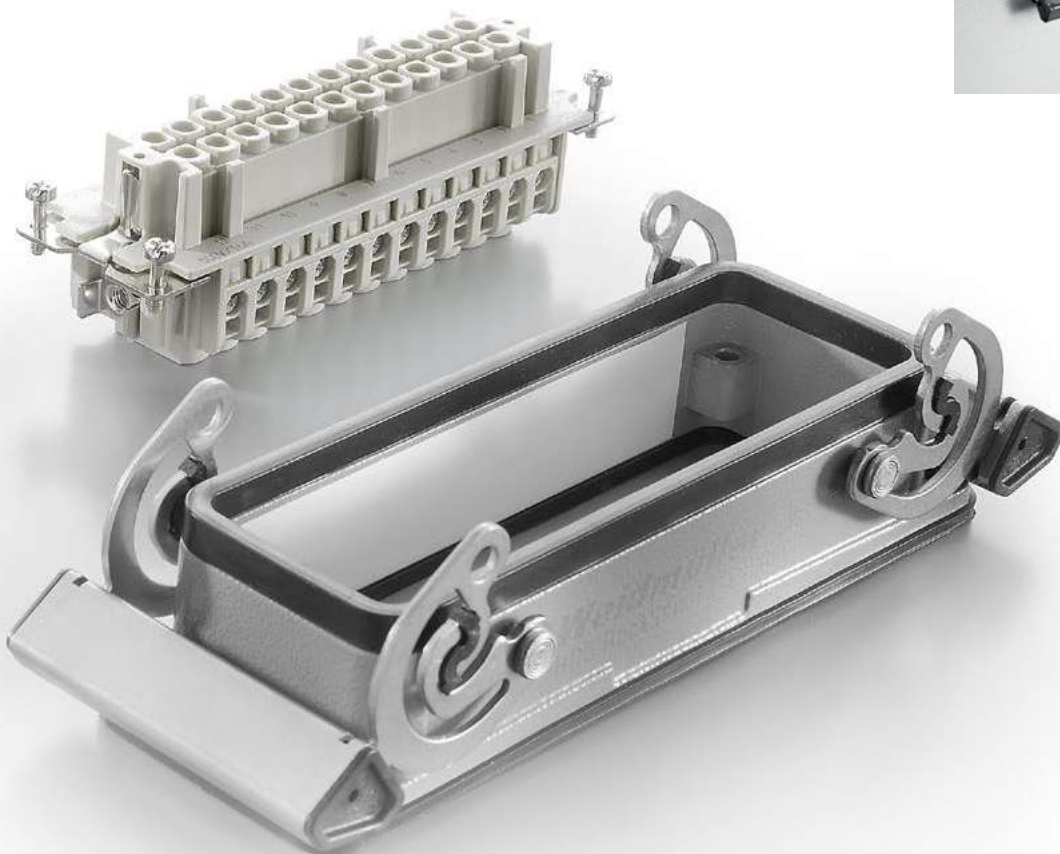

400 V, 16 A, Size 1

Metric versions



Type	Order No.
HDC-KIT-HA 03.300 M	1802470000

Part	Type	Order No.
Socket connector	HDC HA 3 FS	1498200000
Plug	HDC HA 3 MS	1498100000
Bulkhead (feed-through)	HDC 04A ALU	1497600000
Plug housing	HDC 04A TOLU 1M20G	1788820000
Cable glands	VG M20 - MS 68	1772220000

Metal housing



Type	Order No.
HDC-KIT-HA 03.301 M	1802460000

Part	Type	Order No.
Socket connector	HDC HA 3 FS	1498200000
Plug	HDC HA 3 MS	1498100000
Bulkhead (feed-through)	HDC 07A ALU	1652410000
Plug housing	HDC 07A TOLU 1M20G	1788520000
Cable glands	VG M20-1/K68	1772300000

Plastic housing



Type	Order No.
HDC-KIT-HA 03.302 M	1802450000

Part	Type	Order No.
Socket connector	HDC HA 3 FS	1498200000
Plug	HDC HA 3 MS	1498100000
Bulkhead (feed-through)	HDC 04A AWLU	1497700000
Plug housing	HDC 04A TOLU 1M20G	1788820000
Cable glands	VG M20 - MS 68	1772220000

Metal housing

400 V, 16 A, Size 1

PG versions



Type	Order No.
HDC-KIT-HA 03.300	1712560000

Part	Type	Order No.
Socket connector	HDC HA 3 FS	1498200000
Plug	HDC HA 3 MS	1498100000
Bulkhead (feed-through)	HDC 04A ALU	1497600000
Plug housing	HDC 04A TOLU 1PG11G	1652470000
Cable glands	VG 11-MS68	1569080000

Metal housing



Type	Order No.
HDC-KIT-HA 03.301	1712570000

Part	Type	Order No.
Socket connector	HDC HA 3 FS	1498200000
Plug	HDC HA 3 MS	1498100000
Bulkhead (feed-through)	HDC 07A ALU	1652410000
Plug housing	HDC 07A TOLU 1PG11G	1652380000
Cable glands	VG 11-K68	1568990000

Plastic housing



Type	Order No.
HDC-KIT-HA 03.302	1712580000

Part	Type	Order No.
Socket connector	HDC HA 3 FS	1498200000
Plug	HDC HA 3 MS	1498100000
Bulkhead (feed-through)	HDC 04A AWLU	1497700000
Plug housing	HDC 04A TOLU 1PG11G	1652470000
Cable glands	VG 11-MS68	1569080000

Metal housing



Type	Order No.
HDC-KIT-HA 03.404	1712630000

Part	Type	Order No.
Socket connector	HDC HA 3 FS	1498200000
Plug	HDC HA 3 MS	1498100000
Bulkhead (feed-through)	HDC 07A AWLU	1652420000
Plug housing	HDC 07A TOLU 1PG11G	1652380000
Cable glands	VG 11-K68	1568990000

Plastic housing

400 V, 16 A, Size 1

Metric versions



Type	Order No.
HDC-KIT-HA 04.400 M	1802440000

Part	Type	Order No.
Socket connector	HDC HA 4 FS	1498400000
Plug	HDC HA 4 MS	1498300000
Bulkhead (feed-through)	HDC 04A ALU	1497600000
Plug housing	HDC 04A TOLU 1M20G	1788820000
Cable glands	VG M20 - MS 68	1772200000

Metal housing



Type	Order No.
HDC-KIT-HA 04.401 M	1802430000

Part	Type	Order No.
Socket connector	HDC HA 4 FS	1498400000
Plug	HDC HA 4 MS	1498300000
Bulkhead (feed-through)	HDC 07A ALU	1652410000
Plug housing	HDC 07A TOLU 1M20G	1788520000
Cable glands	VG M20-1/K68	1772300000

Plastic housing



Type	Order No.
HDC KIT HA 04.402 M	1802700000

Part	Type	Order No.
Socket connector	HDC HA 4 FS	1498400000
Plug	HDC HA 4 MS	1498300000
Bulkhead (feed-through)	HDC 04A AWLU	1497700000
Plug housing	HDC 04A TOLU 1M20G	1788820000
Cable glands	VG M20 - MS 68	1772200000

Metal housing



Type	Order No.
HDC KIT HA 04.406 M	1802720000

Part	Type	Order No.
Socket connector	HDC HA 4 FS	1498400000
Plug	HDC HA 4 MS	1498300000
Bulkhead (feed-through)	HDC 07A AWLU	1652420000
Plug housing	HDC 07A TOLU 1M20G	1788520000
Cable glands	VG M20-1/K68	1772300000

Plastic housing

400 V, 16 A, Size 1

PG versions



Type	Order No.
HDC-KIT-HA 04.400	1712590000

Part	Type	Order No.
Socket connector	HDC HA 4 FS	1498400000
Plug	HDC HA 4 MS	1498300000
Bulkhead (feed-through)	HDC 04A ALU	1497600000
Plug housing	HDC 04A TOLU 1PG11G	1652470000
Cable glands	VG 11-MS68	1569080000

Metal housing



Type	Order No.
HDC-KIT-HA 04.401	1712600000

Part	Type	Order No.
Socket connector	HDC HA 4 FS	1498400000
Plug	HDC HA 4 MS	1498300000
Bulkhead (feed-through)	HDC 07A ALU	1652410000
Plug housing	HDC 07A TOLU 1PG11G	1652380000
Cable glands	VG 11-K68	1568990000

Plastic housing



Type	Order No.
HDC-KIT-HA 04.402	1712610000

Part	Type	Order No.
Socket connector	HDC HA 4 FS	1498400000
Plug	HDC HA 4 MS	1498300000
Bulkhead (feed-through)	HDC 04A AWLU	1497700000
Plug housing	HDC 04A TOLU 1PG11G	1652470000
Cable glands	VG 11-MS68	1569080000

Metal housing



Type	Order No.
HDC-KIT-HA 04.406	1712650000

Part	Type	Order No.
Socket connector	HDC HA 4 FS	1498400000
Plug	HDC HA 4 MS	1498300000
Bulkhead (feed-through)	HDC 07A AWLU	1652420000
Plug housing	HDC 07A TOLU 1PG11G	1652380000
Cable glands	VG 11-K68	1568990000

Plastic housing

500 V, 24 A, Size 3

Metric versions



Type	Order No.
HDC KIT HE 06.100 M	1802730000

Part	Type	Order No.
Socket connector	HDC HE 6 FS	1200200000
Plug	HDC HE 6 MS	1200000000
Bulkhead (feed-through)	HDC 06B ALU	1202100000
Plug housing	HDC 06B TSLU 1M20G	1788100000
Cable glands	VG M20 - MS 68	1772200000

Metal housing



Type	Order No.
HDC KIT HE 06.101 M	1802740000

Part	Type	Order No.
Socket connector	HDC HE 6 FS	1200200000
Plug	HDC HE 6 MS	1200000000
Bulkhead (feed-through)	HDC 06B ALU	1202100000
Plug housing	HDC 06B TOLU 1M20G	1788120000
Cable glands	VG M20 - MS 68	1772200000

Metal housing

500 V, 24 A, Size 3

PG versions



Type	Order No.
HDC-KIT-HE 06.100	1712460000

Part	Type	Order No.
Socket connector	HDC HE 6 FS	1200200000
Plug	HDC HE 6 MS	1200000000
Bulkhead (feed-through)	HDC 06B ALU	1202100000
Plug housing	HDC 06B TSLU 1PG16G	1652520000
Cable glands	VG 16-MS68	1569100000

Metal housing



Type	Order No.
HDC-KIT-HE 06.101	1712660000

Part	Type	Order No.
Socket connector	HDC HE 6 FS	1200200000
Plug	HDC HE 6 MS	1200000000
Bulkhead (feed-through)	HDC 06B ALU	1202100000
Plug housing	HDC 06B TOLU 1PG16G	1652640000
Cable glands	VG 16-MS68	1569100000

Metal housing

500 V, 24 A, Size 3

metric versions



Type	Order No.
HDC KIT HE-P 06.10 M	1027650000

Part	Type	Order No.
Socket connector	HDC HE 6 FP	1873520000
Plug	HDC HE 6 MP	1873530000
Bulkhead (feed-through)	HDC 06B ALU	1202100000
Plug housing	HDC 06B TSLU 1M20G	1788100000
Cable glands	VG M20 - MS 68	1772220000

Metal housings



Type	Order No.
HDC KIT HE-P 06.11 M	1061720000

Part	Type	Order No.
Socket connector	HDC HE 6 FP	1873520000
Plug	HDC HE 6 MP	1873530000
Bulkhead (feed-through)	HDC 06B ALU	1202100000
Plug housing	HDC 06B TOLU 1M20G	1788120000
Cable glands	VG M20 - MS 68	1772220000

Metal housings

500 V, 24 A, Size 3

PG versions

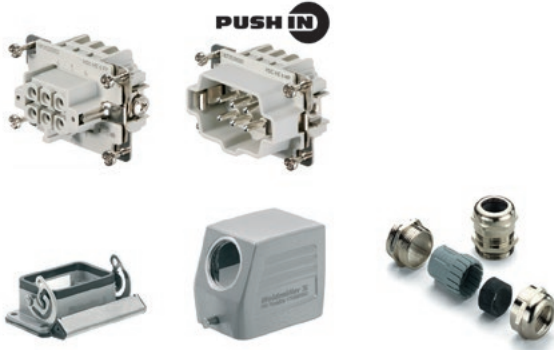

Type	Order No.
HDC KIT HE-P 06.10	1027660000

Part	Type	Order No.
Socket connector	HDC HE 6 FP	1873520000
Plug	HDC HE 6 MP	1873530000
Bulkhead (feed-through)	HDC 06B ALU	1202100000
Plug housing	HDC 06B TSLU 1PG16G	1652520000
Cable glands	VG 16-MS68	1569100000

Metal housings



Type	Order No.
HDC KIT HE-P 06.11	1061710000

Part	Type	Order No.
Socket connector	HDC HE 6 FP	1873520000
Plug	HDC HE 6 MP	1873530000
Bulkhead (feed-through)	HDC 06B ALU	1202100000
Plug housing	HDC 06B TOLU 1PG16G	1652640000
Cable glands	VG 16-MS68	1569100000

Metal housings

500 V, 16 A, Size 4

Metric versions



Type	Order No.
HDC-KIT-HE 10.110 M	1802420000

Part	Type	Order No.
Socket connector	HDC HE 10 FS	1204100000
Plug	HDC HE 10 MS	1203900000
Bulkhead (feed-through)	HDC 10B ABU	1205000000
Plug housing	HDC 10B TSBU 1M25G	1787550000
Cable glands	VG M25 - MS 68	1772230000

Metal housing



Type	Order No.
HDC-KIT-HE 10.111 M	1802410000

Part	Type	Order No.
Socket connector	HDC HE 10 FS	1204100000
Plug	HDC HE 10 MS	1203900000
Bulkhead (feed-through)	HDC 10B ABU	1205000000
Plug housing	HDC 10B TOBU 1M25G	1787590000
Cable glands	VG M25 - MS 68	1772230000

Metal housing

500 V, 16 A, Size 4

PG versions



Type	Order No.
HDC-KIT-HE 10.110	1712510000

Part	Type	Order No.
Socket connector	HDC HE 10 FS	1204100000
Plug	HDC HE 10 MS	1203900000
Bulkhead (feed-through)	HDC 10B ABU	1205000000
Plug housing	HDC 10B TSBU 1PG16G	1654070000
Cable glands	VG 16-MS68	1569100000

Metal housing



Type	Order No.
HDC-KIT-HE 10.111	1712670000

Part	Type	Order No.
Socket connector	HDC HE 10 FS	1204100000
Plug	HDC HE 10 MS	1203900000
Bulkhead (feed-through)	HDC 10B ABU	1205000000
Plug housing	HDC 10B TOBU 1PG16G	1654220000
Cable glands	VG 16-MS68	1569100000

Metal housing

500 V, 16 A, Size 4

Metric versions

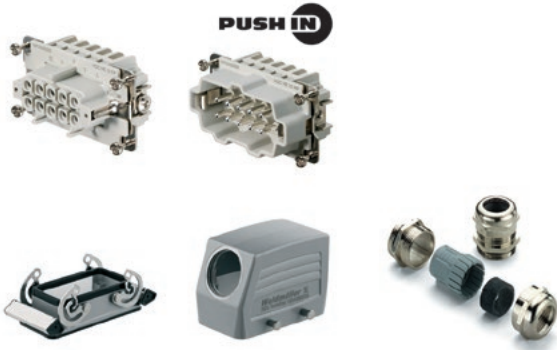

Type	Order No.
HDC KIT HE-P 10.110 M	1027670000

Part	Type	Order No.
Socket connector	HDC HE 10 FP	1873540000
Plug	HDC HE 10 MP	1873550000
Bulkhead (feed-through)	HDC 10B ABU	1205000000
Plug housing	HDC 10B TSBU 1M25G	1787550000
Cable glands	VG M25 - MS 68	1772230000

Metal housings



Type	Order No.
HDC KIT HE-P 10.111 M	1061740000

Part	Type	Order No.
Socket connector	HDC HE 10 FP	1873540000
Plug	HDC HE 10 MP	1873550000
Bulkhead (feed-through)	HDC 10B ABU	1205000000
Plug housing	HDC 10B TOBU 1M25G	1787590000
Cable glands	VG M25 - MS 68	1772230000

Metal housings

500 V, 16 A, Size 4

PG versions



Type	Order No.
HDC KIT HE-P 10.110	1027680000

Part	Type	Order No.
Socket connector	HDC HE 10 FP	1873540000
Plug	HDC HE 10 MP	1873550000
Bulkhead (feed-through)	HDC 10B ABU	1205000000
Plug housing	HDC 10B TSBU 1PG16G	1654070000
Cable glands	VG 16-MS68	1569100000

Metal housings

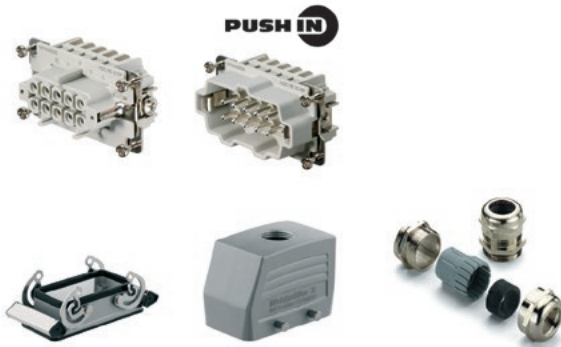

Type	Order No.
HDC KIT HE-P 10.111	1061730000

Part	Type	Order No.
Socket connector	HDC HE 10 FP	1873540000
Plug	HDC HE 10 MP	1873550000
Bulkhead (feed-through)	HDC 10B ABU	1205000000
Plug housing	HDC 10B TOBU 1PG16G	1654220000
Cable glands	VG 16-MS68	1569100000

Metal housings

500 V, 16 A, Size 6

Metric versions



Type	Order No.
HDC-KIT-HE 16.120 M	180240000

Part	Type	Order No.
Socket connector	HDC HE 16 FS	1207700000
Plug	HDC HE 16 MS	1207500000
Bulkhead (feed-through)	HDC 16B ABU	1208600000
Plug housing	HDC 16B TSBU 1M25G	1788180000
Cable glands	VG M25 - MS 68	1772230000

Metal housing



Type	Order No.
HDC-KIT-HE 16.121 M	1802390000

Part	Type	Order No.
Socket connector	HDC HE 16 FS	1207700000
Plug	HDC HE 16 MS	1207500000
Bulkhead (feed-through)	HDC 16B ABU	1208600000
Plug housing	HDC 16B TOBU 1M25G	1788210000
Cable glands	VG M25 - MS 68	1772230000

Metal housing

500 V, 16 A, Size 6

PG versions



Type	Order No.
HDC-KIT-HE 16.120	1712520000

Part	Type	Order No.
Socket connector	HDC HE 16 FS	1207700000
Plug	HDC HE 16 MS	1207500000
Bulkhead (feed-through)	HDC 16B ABU	1208600000
Plug housing	HDC 16B TSBU 1PG21G	1656480000
Cable glands	VG 21-MS68	1569110000

Metal housing



Type	Order No.
HDC-KIT-HE 16.121	1712680000

Part	Type	Order No.
Socket connector	HDC HE 16 FS	1207700000
Plug	HDC HE 16 MS	1207500000
Bulkhead (feed-through)	HDC 16B ABU	1208600000
Plug housing	HDC 16B TOBU 1PG21G	1656590000
Cable glands	VG 21-MS68	1569110000

Metal housing

500 V, 16 A, Size 6

Metric versions



Type	Order No.
HDC KIT HE-P 16.120 M	1027690000

Part	Type	Order No.
Socket connector	HDC HE 16 FP	1873560000
Plug	HDC HE 16 MP	1873570000
Bulkhead (feed-through)	HDC 16B ABU	1208600000
Plug housing	HDC 16B TSBU 1M25G	1788180000
Cable glands	VG M25 - MS 68	1772230000

Metal housings



Type	Order No.
HDC KIT HE-P 16.121 M	1061770000

Part	Type	Order No.
Socket connector	HDC HE 16 FP	1873560000
Plug	HDC HE 16 MP	1873570000
Bulkhead (feed-through)	HDC 16B ABU	1208600000
Plug housing	HDC 16B TOBU 1M25G	1788210000
Cable glands	VG M25 - MS 68	1772230000

Metal housings

500 V, 16 A, Size 6

PG versions



Type	Order No.
HDC KIT HE-P 16.120	1027640000

Part	Type	Order No.
Socket connector	HDC HE 16 FP	1873560000
Plug	HDC HE 16 MP	1873570000
Bulkhead (feed-through)	HDC 16B ABU	1208600000
Plug housing	HDC 16B TSBU 1PG21G	1656480000
Cable glands	VG 21-MS68	1569110000

Metal housings

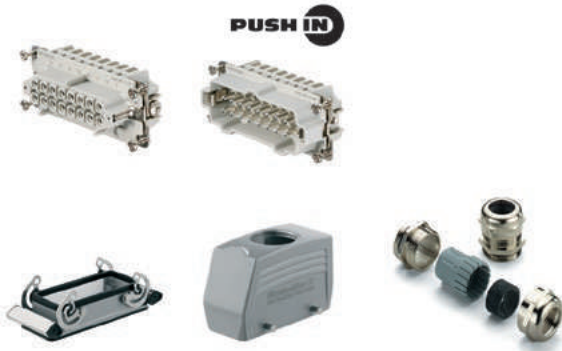

Type	Order No.
HDC KIT HE-P 16.121	1061750000

Part	Type	Order No.
Socket connector	HDC HE 16 FP	1873560000
Plug	HDC HE 16 MP	1873570000
Bulkhead (feed-through)	HDC 16B ABU	1208600000
Plug housing	HDC 16B TOBU 1PG21G	1656590000
Cable glands	VG 21-MS68	1569110000

Metal housings

500 V, 16 A, Size 8

Metric versions



Type	Order No.
HDC-KIT-HE 24.130 M	1802380000

Part	Type	Order No.
Socket connector	HDC HE 24 FS	1211300000
Plug	HDC HE 24 MS	1211100000
Bulkhead (feed-through)	HDC 24B ABU	1212400000
Plug housing	HDC 24B TSBU 1M32G	1787750000
Cable glands	VG M32 - MS 68	1772240000

Metal housing



Type	Order No.
HDC-KIT-HE 24.131 M	1802480000

Part	Type	Order No.
Socket connector	HDC HE 24 FS	1211300000
Plug	HDC HE 24 MS	1211100000
Bulkhead (feed-through)	HDC 24B ABU	1212400000
Plug housing	HDC 24B TOBU 1M32G	1787810000
Cable glands	VG M32 - MS 68	1772240000

Metal housing

500 V, 16 A, Size 8

PG versions



Type	Order No.
HDC-KIT-HE 24.130	1712530000

Part	Type	Order No.
Socket connector	HDC HE 24 FS	1211300000
Plug	HDC HE 24 MS	1211100000
Bulkhead (feed-through)	HDC 24B ABU	1212400000
Plug housing	HDC 24B TSBU 1PG21G	1661230000
Cable glands	VG 21-MS68	1569110000

Metal housing



Type	Order No.
HDC-KIT-HE 24.131	1712690000

Part	Type	Order No.
Socket connector	HDC HE 24 FS	1211300000
Plug	HDC HE 24 MS	1211100000
Bulkhead (feed-through)	HDC 24B ABU	1212400000
Plug housing	HDC 24B TOBU 1PG21G	1661370000
Cable glands	VG 21-MS68	1569110000

Metal housing

500 V, 16 A, Size 8

Metric versions

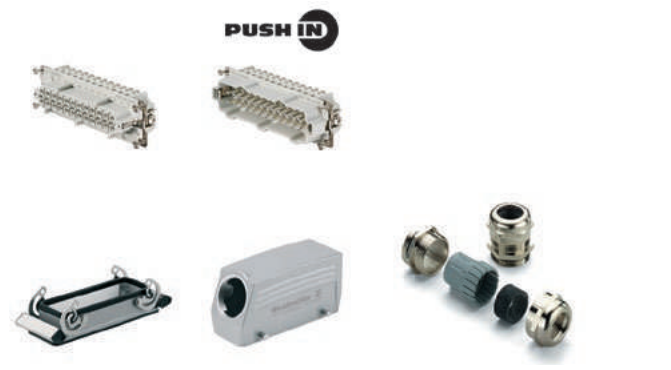

Type	Order No.
HDC KIT HE-P 24.130 M	1061790000

Part	Type	Order No.
Socket connector	HDC HE 24 FP	1873580000
Plug	HDC HE 24 MP	1873590000
Bulkhead (feed-through)	HDC 24B ABU	1212400000
Plug housing	HDC 24B TSBU 1M32G	1787750000
Cable glands	VG M32 - MS 68	1772240000

Metal housings



Type	Order No.
HDC KIT HE-P 24.131 M	1061700000

Part	Type	Order No.
Socket connector	HDC HE 24 FP	1873580000
Plug	HDC HE 24 MP	1873590000
Bulkhead (feed-through)	HDC 24B ABU	1212400000
Plug housing	HDC 24B TOBU 1M32G	1787810000
Cable glands	VG M32 - MS 68	1772240000

Metal housings

500 V, 16 A, Size 8

PG versions



Type	Order No.
HDC KIT HE-P 24.130	1061780000

Part	Type	Order No.
Socket connector	HDC HE 24 FP	1873580000
Plug	HDC HE 24 MP	1873590000
Bulkhead (feed-through)	HDC 24B ABU	1212400000
Plug housing	HDC 24B TSBU 1PG21G	1661230000
Cable glands	VG 21-MS68	1569110000

Metal housings



Type	Order No.
HDC KIT HE-P 24.131	1061800000

Part	Type	Order No.
Socket connector	HDC HE 24 FP	1873580000
Plug	HDC HE 24 MP	1873590000
Bulkhead (feed-through)	HDC 24B ABU	1212400000
Plug housing	HDC 24B TOBU 1PG21G	1661370000
Cable glands	VG 21-MS68	1569110000

Metal housings

RockStar® Kits with HE inserts, 32 pole

500 V, 16 A, Size 10

Metric versions



Type	Order No.
HDC-KIT-HE 32.140 M	1802370000

Part	Type	Order No.
Socket connector	HDC HE 16 FS	1207700000
Socket connector	HDC HE 16 FS 17-32	1216100000
Plug	HDC HE 16 MS	1207500000
Plug	HDC HE 16 MS 17-32	1215700000
Bulkhead (feed-through)	HDC 32B ABU	1217800000
Plug housing	HDC 32B TSBU 1M32G	1788400000
Cable glands	VG M32 - MS 68	1772240000

Metal housing

500 V, 16 A, Size 10

PG versions



Type	Order No.
HDC-KIT-HE 32.140	1712540000

Part	Type	Order No.
Socket connector	HDC HE 16 FS	1207700000
Socket connector	HDC HE 16 FS 17-32	1216100000
Plug	HDC HE 16 MS	1207500000
Plug	HDC HE 16 MS 17-32	1215700000
Bulkhead (feed-through)	HDC 32B ABU	1217800000
Plug housing	HDC 32B TSBU 1PG29G	1666840000
Cable glands	VG 29-MS68	1569120000

Metal housing

RockStar® Kits with HE inserts, 48 pole

500 V, 16 A, Size 12

Metric versions



Type	Order No.
HDC-KIT-HE 48.150 M	1802360000

Part	Type	Order No.
Socket connector	HDC HE 24 FS	1211300000
Socket connector	HDC HE 24 FS 25-48	1221200000
Plug	HDC HE 24 MS	1211100000
Plug	HDC HE 24 MS 25-48	1220800000
Bulkhead (feed-through)	HDC 48B ADLU	1222900000
Plug housing	HDC 48B TSLU 1M40G	1788310000
Cable glands	VG M40 - MS 68	1772250000

Metal housing

500 V, 16 A, Size 12

PG versions



Type	Order No.
HDC-KIT-HE 48.150	1712550000

Part	Type	Order No.
Socket connector	HDC HE 24 FS	1211300000
Socket connector	HDC HE 24 FS 25-48	1221200000
Plug	HDC HE 24 MS	1211100000
Plug	HDC HE 24 MS 25-48	1220800000
Bulkhead (feed-through)	HDC 48B ADLU	1222900000
Plug housing	HDC 48B TSLU 1PG29G	1650850000
Cable glands	VG 29-MS68	1569120000

Metal housing

RockStar® Kits with HSB inserts, 6 pole

400 V, 35 A, Size 6

PG versions



Type	Order No.
HDC-KIT-HSB 06.500	172400000

Part	Type	Order No.
Socket connector	HDC HSB 6 FS	1498900000
Plug	HDC HSB 6 MS	1498700000
Bulkhead (feed-through)	HDC 16B ABU	1208600000
Plug housing	HDC 16B TSBU 1PG21G	1656480000
Cable glands	VG 21-MS68	1569110000

Metal housing

RockStar® accessories, tools and cable glands

RockStar® accessories	Introduction	J.2
	Crimp contacts	J.4
	Fibre optic contacts	J.10
	Coding	J.12
	Shield lever	J.16
	Grip panels	J.19
	Docking frame	J.20
	Other accessories	J.22
	Tools	Cutting
	Crimping	J.29
	Screwdrivers	J.32
	Miscellaneous	J.38
	Stripping and crimping machines	J.39
Cable glands	Introduction	J.40
	Standard cable glands - Plastic	J.42
	Standard cable glands - Brass	J.44
	EMC cable glands	J.47
	Standard cable glands - Stainless steel	J.49
	IP65 cable gland with multi-wire sealing	J.51
	Standard cable glands	J.52
	Accessories - Lock nuts	J.53
	Accessories - Flat IP washer	J.59
	Blanking plugs	J.62
	Adapter	J.64

RockStar® Accessories

In addition to heavy-duty connectors, RockStar® also includes functional and safety accessories – including crimp contacts, coding systems and shield clamps – to help you with your facility cabling.

A technically proper crimp connection should be gas-tight and corrosion-resistant. Machined crimp contacts are available with different performance requirements and with either silver or gold plating.

When aligning multiple connectors with similar mating profiles within one facility, you must safeguard against accidental plugging mistakes. The RockStar® product line also includes the corresponding locking pins, coding systems and pole coding for this purpose.

If multiple shielded cables are being fed into the connector housing using a flexible hose or a multi-cable feed, then the shielding should normally be connected to a shield clamp attached to an insert. The potential is conducted to the housing using the metallic transition. The shielded conductor is fastened to the shield clamp with shield clips, which are available in a variety of sizes.



Solid

Weidmüller's coding system can help you to clearly classify and organise your connectors while also ensuring that they cannot be plugged in incorrectly.



Secure

Solid, machined crimped contacts ensure a gas-tight and corrosion-resistant crimp.

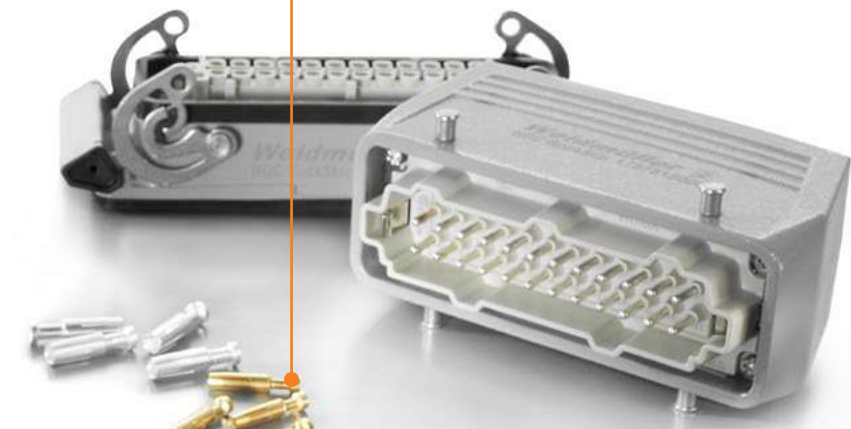
**Optimised shielding**

Shield clamps and shield clips allow the shield to be directly attached to the connector housing.

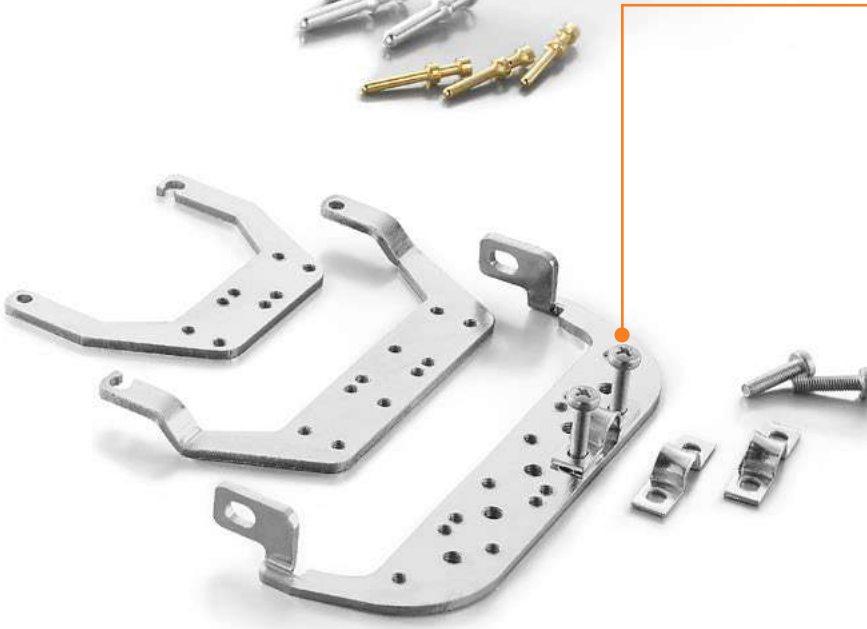

Crimp contacts

Crimp contacts for fixed-pole inserts

Technical data

	for HD and HDD inserts	for HE and HEE inserts
Material	Copper alloy	Copper alloy
Surface hard gold-plated	0.8 µm	0.8 µm
Surface hard silver-plated	3 µm	3 µm
Contact resistance	≤ 4 mΩ	≤ 2 mΩ
Clamping range	0.14 ... 2.5 mm ² 26 ... 14 AWG	0.5 ... 4.0 mm ² 20 ... 12 AWG
Stripping length	8 mm	7.5 mm

For HD and HDD inserts

Crimp contacts

Surface Gold



Surface Silver



Male

Qty.	Type	Order No.	Type	Order No.
100	HDC-C-HD-SM0.14-0.37AU	1651620000	HDC-C-HD-BM0.14-0.37AU	1651670000
100	HDC-C-HD-SM0.5AU	1651630000	HDC-C-HD-BM0.5AU	1651680000
100	HDC-C-HD-SM0.75-1.00AU	1651640000	HDC-C-HD-BM0.75-1.00AU	1651690000
100	HDC-C-HD-SM1.5AU	1651650000	HDC-C-HD-BM1.5AU	1651700000
100	HDC-C-HD-SM2.5AU	1651660000	HDC-C-HD-BM2.5AU	1651710000
100	HDC-C-HD-SM0.14-0.37AG	1651520000	HDC-C-HD-BM0.14-0.37AG	1651570000
100	HDC-C-HD-SM0.5AG	1651530000	HDC-C-HD-BM0.5AG	1651580000
100	HDC-C-HD-SM0.75-1.00AG	1601750000	HDC-C-HD-BM0.75-1.00AG	1601760000
100	HDC-C-HD-SM1.5AG	1651550000	HDC-C-HD-BM1.5AG	1651600000
100	HDC-C-HD-SM2.5AG	1651560000	HDC-C-HD-BM2.5AG	1651610000

Female

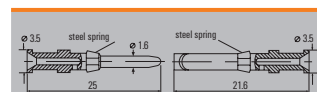

Conductor cross-section	Insulation stripping length
0.14 - 0.37 mm ²	AWG 26-22 8 mm
0.50 mm ²	AWG 20 8 mm
0.75 - 1.00 mm ²	AWG 18 8 mm
1.50 mm ²	AWG 16 8 mm
2.50 mm ²	AWG 14 8 mm

Tools



Crimping tool	Order No.
CTX CM 1,6 / 2,5	9018490000
CTIN CM 1.6/2.5	9205430000
Contact release tool	
Removal Tool HD	1866730000

For HE, HEE and HEEE inserts

Crimp contacts

Surface Gold



Surface Silver



Male

Qty.	Type	Order No.	Type	Order No.
100	HDC-C-HE-SM0.5AU	1651420000	HDC-C-HE-BM0.5AU	1651470000
100	HDC-C-HE-SM0.75-1.00AU	1651430000	HDC-C-HE-BM0.75-1.00AU	1651480000
100	HDC-C-HE-SM1.5AU	1651440000	HDC-C-HE-BM1.5AU	1651490000
100	HDC-C-HE-SM2.5AU	1651450000	HDC-C-HE-BM2.5AU	1651500000
100	HDC-C-HE-SM4.0AU	1651460000	HDC-C-HE-BM4.0AU	1651510000
100	HDC-C-HE-SM4.65AU	1116540000	HDC-C-HE-BM4.65AU	1116530000
100	HDC-C-HE-SM0.5AG	1200500000	HDC-C-HE-BM0.5AG	1201100000
100	HDC-C-HE-SM0.75-1.00AG	1200600000	HDC-C-HE-BM0.75-1.00AG	1201200000
100	HDC-C-HE-SM1.5AG	1200700000	HDC-C-HE-BM1.5AG	1201300000
100	HDC-C-HE-SM2.5AG	1200800000	HDC-C-HE-BM2.5AG	1201400000
100	HDC-C-HE-SM4.0AG	1200900000	HDC-C-HE-BM4.0AG	1201500000

Female



Conductor cross-section	Insulation stripping length
0.50 mm ²	AWG 20 7.5 mm
0.75 - 1.00 mm ²	AWG 18 7.5 mm
1.50 mm ²	AWG 16 7.5 mm
2.50 mm ²	AWG 14 7.5 mm
4.00 mm ²	AWG 12 7.5 mm
4.65 mm ²	AWG 11 7.5 mm

Tools



Crimping tool	Order No.
CTX CM 1,6 / 2,5	9018490000
CTIN CM 1.6/2.5	9205430000
Contact release tool	
Removal Tool HE	1866750000

Crimp contacts for ModuPlug modules

Technical data

	für COAX Modul	für MGBIT 8 Modul
Material	Copper alloy	Copper alloy
Surface	Gold	Gold
Connection type	Crimp connection, solder connection	Crimp connection
Conductor cross-section	0.14 ... 2.5 mm ²	0.08 ... 0.12 mm ²

For COAX module

Crimp, solder contacts



Male

Qty.	Type	Order No.	Type	Order No.
10	HDC C COAX 50 M	2748670000	HDC C COAX 50 F	2748660000
10	HDC C COAX 75 M	2748690000	HDC C COAX 75 F	2748680000

Female

Tools



Crimping tool for COAX 50 contacts	Order No.
HTG 174	9012410000
Crimping tool for COAX 75 contacts	Order No.
HTX 188	9011990000

For MGBIT 8 module

Crimp contacts



Male

Qty.	Type	Order No.	Type	Order No.
100	HDC C HS SM0.08-0.12 AU	2748710000	HDC C HS BM0.08-0.12 AU	2748730000
100	HDC C HS SM0.2-0.5 AU	2748700000	HDC C HS BM0.2-0.5 AU	2748720000

Female

Tools



Crimping tool	Order No.
HDC MBUS CT	2592650000

Crimp contacts

Crimp contacts for fixed-pole inserts

Technical data

	For HQ and MixMate inserts	CM-3
Material	Copper alloy	Copper alloy
Surface hard silver-plated	3 µm	3 µm
Contact resistance	≤ 1 mΩ	≤ 1 mΩ
Clamping range	1.5 ... 6 mm ²	1.5 ... 10 mm ²
	16 ... 10 AWG	16 ... 7 AWG
Stripping length	8 mm	10 mm

For HQ and MixMate inserts

Crimp contacts

Surface Silver



Male

Qty.	Type	Order No.	Type	Order No.
25	HDC C HX SM1.5AG	1002910000	HDC C HX BM1.5AG	1002950000
25	HDC C HX SM2.5AG	1002920000	HDC C HX BM2.5AG	1002960000
25	HDC C HX SM4.0AG	1002930000	HDC C HX BM4.0AG	1002970000
25	HDC C HX SM6.0AG	1002940000	HDC C HX BM6.0AG	1002980000

Female

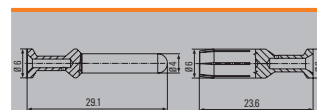

Conductor cross-section	Insulation stripping length
1.50 mm ²	AWG 16 8 mm
2.50 mm ²	AWG 14 8 mm
4.00 mm ²	AWG 12 8 mm
6.00 mm ²	AWG 10 8 mm

Tools



Crimping tool	Order No.
CTIN CM 1.6/2.5	9205430000
Contact release tool	Order No.
Removal Tool HX	1002990000

High Power signal contacts

Crimp contacts

Surface Silver



Male

Qty.	Type	Order No.	Type	Order No.
100	HDC-C-M3-SM1.5AG	1698120000	HDC-C-M3-BM1.5AG	1698130000
100	HDC-C-M3-SM2.5AG	1698140000	HDC-C-M3-BM2.5AG	1698150000
100	HDC-C-M3-SM4.0AG	1682260000	HDC-C-M3-BM4.0AG	1682270000
100	HDC-C-M3-SM6.0AG	1682280000	HDC-C-M3-BM6.0AG	1682290000
100	HDC-C-M3-SM10.0AG	1682300000	HDC-C-M3-BM10.0AG	1682310000

Female

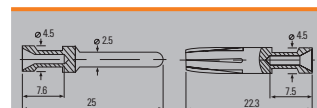

Conductor cross-section	Insulation stripping length
0.50 mm ²	AWG 20 7.5 mm
0.75 - 1.00 mm ²	AWG 18 7.5 mm
1.50 mm ²	AWG 16 7.5 mm
2.50 mm ²	AWG 14 7.5 mm
4.00 mm ²	AWG 12 7.5 mm
4.65 mm ²	AWG 11 7.5 mm

Tools



Crimping tool	Order No.
CTX CM 1,6 / 2,5	9018490000
CTIN CM 1.6/2.5	9205430000
CTX CM 3,6	9018480000
CTIN CM 3.6	9205440000
Contact release tool	Order No.
Removal Tool CM3	1866710000

Crimp contacts for ModuPlug inserts

For MHP 70 module

Crimp contacts

Surface Silver



Male			Female		
Qty.	Type	Order No.	Type	Order No.	
10	HDC MHP70 M 6	2668280000	HDC MHP70 F 6	2668210000	
10	HDC MHP70 M 6 P	2691190000			
10	HDC MHP70 M 10	2668350000	HDC MHP70 F 10	2668200000	
10	HDC MHP70 M 10 P	2691240000			
10	HDC MHP70 M 16	2668360000	HDC MHP70 F 16	2668220000	
10	HDC MHP70 M 16 P	2691250000			
10	HDC MHP70 M 25	2668370000	HDC MHP70 F 25	2668260000	
10	HDC MHP70 M 25 P	2691260000			

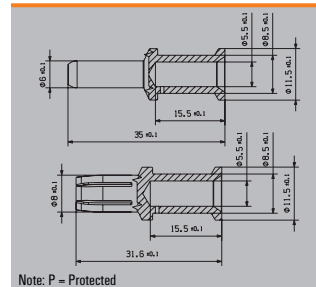

For MHP 100 module

Crimp contacts

Surface Silver



Male			Female		
Qty.	Type	Order No.	Type	Order No.	
10	HDC MHP100 M 10	1435750000	HDC MHP100 F 10	1435790000	
10	HDC MHP100 M 16	1435760000	HDC MHP100 F 16	1435810000	
10	HDC MHP100 M 25	1435770000	HDC MHP100 F 25	1435820000	
10	HDC MHP100 M 35	1435780000	HDC MHP100 F 35	1435830000	

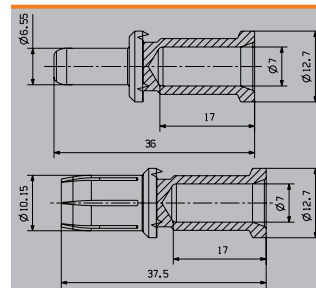

For MHP 200 module

Crimp contacts

Surface Silver



Male			Female		
Qty.	Type	Order No.	Type	Order No.	
10	HDC MHP200 M 25	2514860000	HDC MHP200 F 25	2514820000	
10	HDC MHP200 M 35	2514870000	HDC MHP200 F 35	2514830000	
10	HDC MHP200 M 50	2514880000	HDC MHP200 F 50	2514840000	
10	HDC MHP200 M 70	2514890000	HDC MHP200 F 70	2514850000	

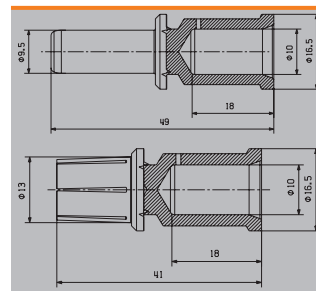

EPG 45



Crimping tool	Order No.
EPG 45	1500830000

Crimp contacts

Crimp contacts for HighPower

Technical data

for HighPower 250 A	
Material	Copper alloy
Surface hard silver-plated	3-5 µm
Contact resistance	≤ 0.1 mΩ
Clamping range	25 ... 95 mm ²
	AWG 4 ... AWG 000
Stripping length	30 mm*

For HighPower 250 A

Crimp contacts



Wire connection cross-section	Male Type	Order No.	Female Type	Order No.
25 mm ²	HDC HP 250 M 25	1079690000	HDC HP 250 F 25	1079720000
35 mm ²	HDC HP 250 M 35	1079680000	HDC HP 250 F 35	1079730000
50 mm ²	HDC HP 250 M 50	1119080000	HDC HP 250 F 50	1079740000
70 mm ²	HDC HP 250 M 70	1119090000	HDC HP 250 F 70	1079750000
95 mm ²	HDC HP 250 M 95	1119100000	HDC HP 250 F 95	1079770000
Insulated PE contact				
50 mm ²	HDC HP 250 M 50 PE	1220850000	HDC HP 250 F 50 PE	1220840000

Note In the version described here, the crimp contacts can be used for crimp connections with flexible, stranded, and finely stranded copper wires (according to DIN 48201 part 1 and DIN 57 295 VDE 0295) or with crimping inserts (according to DIN 48083 part 1, part 3 and part 4). We would be glad to customise the crimp contact to fit your requirements.

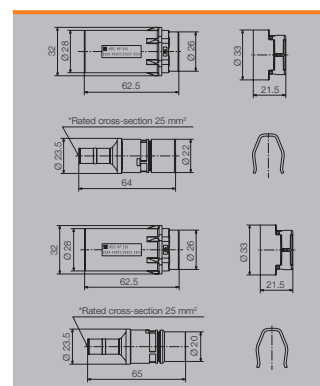

Technical data

for HighPower 550 A	
Material	Copper alloy
Surface hard silver-plated	3-5 µm
Contact resistance	≤ 0.1 mΩ
Clamping range	50 ... 240 mm ²
	AWG 1/0 ... kcmil 500
Stripping length	30 mm*

For HighPower 550 A

Crimp contacts



Wire connection cross-section	Male Type	Order No.	Female Type	Order No.
25 mm ²	HDC HP 550 M 25	1220580000	HDC HP 550 F 25	1220570000
50 mm ²	HDC HP 550 M 50	1157800000	HDC HP 550 F 50	1177100000
70 mm ²	HDC HP 550 M 70	1268810000	HDC HP 550 F 70	1268820000
95 mm ²	HDC HP 550 M 95	1079790000	HDC HP 550 F 95	1079810000
120 mm ²	HDC HP 550 M 120	1079780000	HDC HP 550 F 120	1079820000
150 mm ²	HDC HP 550 M 150	1119110000	HDC HP 550 F 150	1079830000
185 mm ²	HDC HP 550 M 185	1120580000	HDC HP 550 F 185	1079840000
240 mm ²	HDC HP 550 M 240	1120590000	HDC HP 550 F 240	1120600000

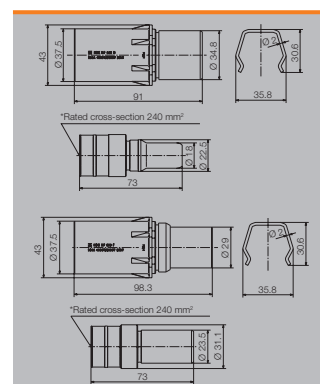

Fibre optic contacts

Fibre optic contacts



Fibre-optic cables guarantee interference-free transmission without any feedback.

The new fibre-optic contacts can now also be used in heavy-duty connectors. Their shape corresponds to that of our proven HD contacts for connecting conventional copper wires. Accordingly, they can be assembled in existing connectors of the HD series, as well as being suitable for use with the ConCept modular system. It is even possible to connect fibre-optic wires and copper wires in a single connector.

The advantages at a glance:

- Immune to electromagnetic interference
- Absolute contact separation
- Weight reduction by dispensing with copper wires
- High transmission capacity and large bandwidth
- All advantages now also available for robust industrial environments

HDC-C-HD ... LWL 1.0 POF

Technical data

Connection for POF cable	
Maximum outer diameter	2.2 mm
Polymer fibre diameter	1.0 mm
Attenuation	
- Requirement to DIN IEC Part 7 Section 2/05.94:	< 3 dB
- the HDC-C-HD LWL contacts in plugged-in state:	< 2 dB
Material	
Temperature range	-40 °C to +85 °C
Contact material	Nickel-silver
Over-spring	Copper alloy

Ordering data



Qty.	Male	Order No.	Female	Order No.
5	HDC-C-HD-S-LWL 1.0 POF	1773630000	HDC-C-HD-B-LWL 1.0 POF	1773640000

HD inserts must be ordered separately

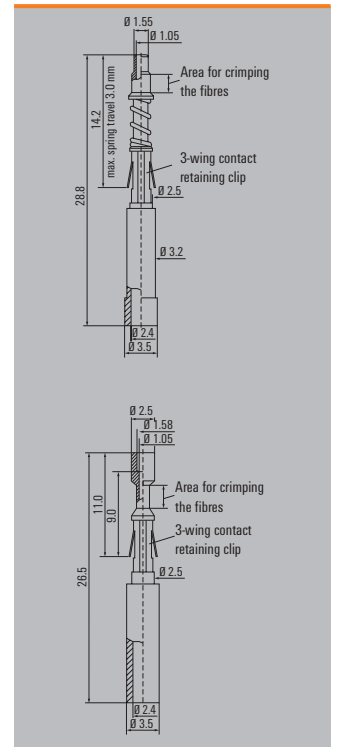

Instructions for assembling fibre optic contacts

1. Cut POF cable (polymer optical fibre) to the required length with cutting tool (we recommend the KT 8).
2. The end face of the fibre of 2.2 mm POF cables must be polished before crimping onto the fibre optic contact. Insert end of POF cable into polishing disc and polish with polishing sheet placed on a smooth surface (e.g. glass plate). Wipe away any residues after polishing. The best optical attenuation values are obtained with wet polishing.
3. Strip sheath of 2.2 mm POF cable to at least 14 mm for female contacts (HDC-C-HD-B-LWL) and at least 19 mm for male contacts (HDC-C-HD-S-LWL).
4. Crimping:
 - A. Insert POF cable into male contact, then both together into the crimping die.
 - B. The female contact has to be inserted angled slightly downwards into the die.
Make sure the end face of the contact and the plastic fibre press against the locator.
 - C. Squeeze the hand levers until the tool unlocks.
 - D. Release option in case of incorrect operation.

A. Male

B. Female

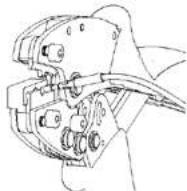
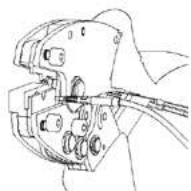

C.

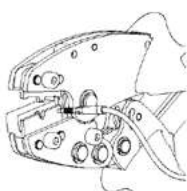
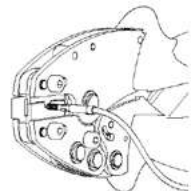

D.

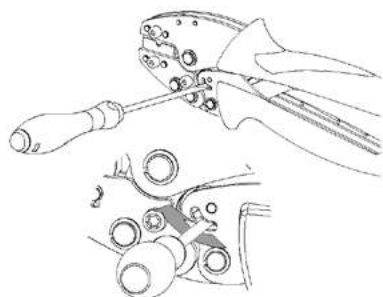

Cutting tool

including positioning sleeve



Type	Qty.	Order No.
KT8	1	1096180000

Polishing disc for fibre-optic cable

Polishing sheet, 1,000 grit size



Type	Qty.	Order No.
PS LWL/POF	1	9020390000
PB LWL/POF	1	9020400000

Stripping tool

for fibre-optic cable



Type	Qty.	Order No.
AM LWL/POF	1	9020360000

Crimping tool

for fibre-optic set



Type	Qty.	Order No.
HTX-HDC/POF	1	9010950000

Contact release tool

for removing machined HD and fibre-optic contacts



Type	Qty.	Order No.
Removal Tool HD	1	1866730000

Coding

Coding pins

Where several connectors of similar type are arranged on a machine, it is essential to avoid the risk of connectors being inserted in the wrong place.

If you have up to six connectors to code, Weidmüller coding pins are the simplest solution. They allow six secure coding variations.

In this case, you substitute two M3 fastening screws on the female insert by coding pins. On the male insert, you leave the opposing fastening screws where they are and substitute the others by coding pins. You then have a pair of inserts that fit together. The coding diagram illustrates the system.

Ordering data

Type	Qty.	Order No.
SPB-M 3	10	1203600000



Allow 4 coding pins for each connector.

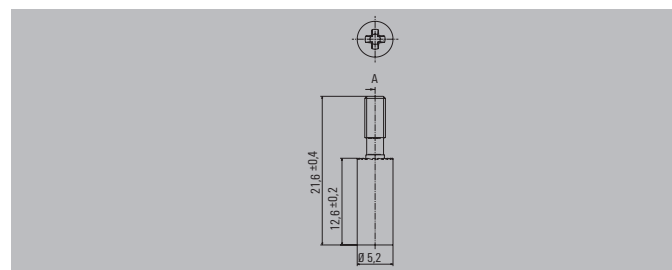

Coding arrangement for coding pins

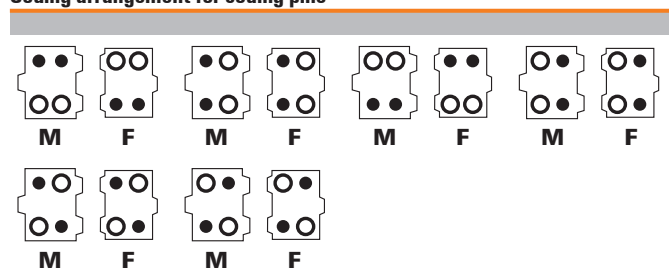

Coding system with guiding function

If you have more than six connectors of similar type to code, you need coding pins and coding sockets. Replace all M3 fastening screws of an insert by two coding pins and two coding sockets. You then fit two coding pins and two coding sockets to the mating insert, in a complementary arrangement.

Fit coding pins to the other connectors in the same way, but with a different arrangement. The coding diagram illustrates the system. The coding sockets cannot be used in combination with separate housing covers

Ordering data DSTV

For fixed-pole inserts



Cod. socket 5 mm dia 
Cod. pin 4 mm dia 

Type	Qty.	Order No.
DSTV COST4	100	1471300000
DSTV COBU5	100	1471500000

Plan to have four coding pins and four coding sockets for each connector.

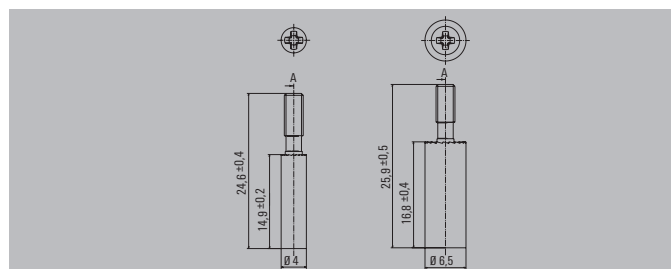

Coding arrangement for coding pins

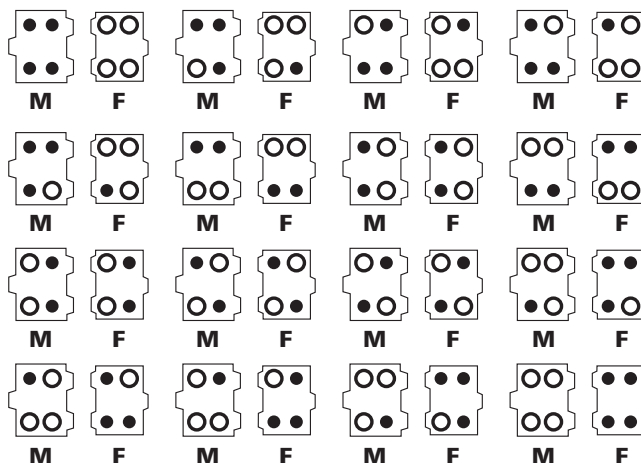

Ordering data HDC CM

For ModuPlug metal frames



Cod. socket 5 mm dia 
Cod. pin 4 mm dia 

Type	Qty.	Order No.
HDC CM	100	1202660000
GUIDING PIN		
HDC CM	100	1202670000
GUIDING SOCKET		

Plan to have four coding pins and four coding sockets for each connector.

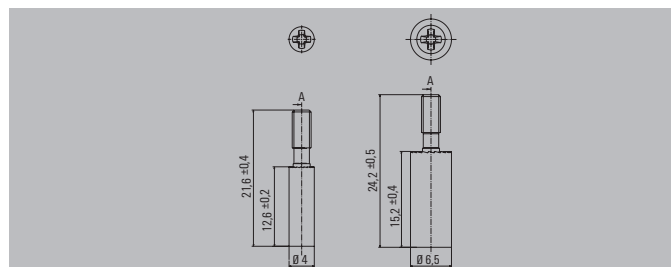

Coding

Assembly instructions for the coding system for the RockStar® HDC HighPower connectors

The coding elements (available under Accessories) can be used to code up to six connectors.

Ordering data

Coding pin	Type	Order No.
	HDC HP CODING SYSTEM	1160780000

Coding arrangement Male/Female

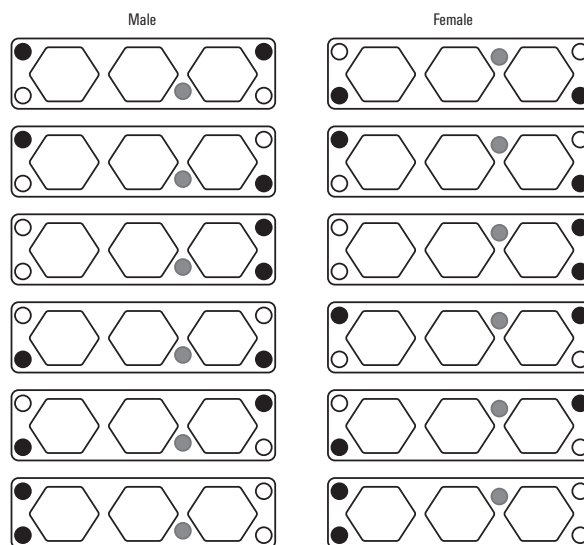

HE coding pin

Use the HE coding pin for a quick and simple solution to avoid mixing up your plug-in connections. The coding pin can be inserted into a single contact chamber (instead of a crimp contact) on both the male and female side of the connector. The opposite mated contact then remains free. The HE coding pin can be used to code all inserts and modules using HE-series crimp contacts.

These include the following:

- HA crimp inserts
- HE crimp inserts
- HEE inserts
- HEEE inserts
- HQ 5 insert
- HQ 8 insert
- S8/24 insert (power contacts)

Ordering data

Type	Qty.	Order No.
HDC HE CP	100	1003240000

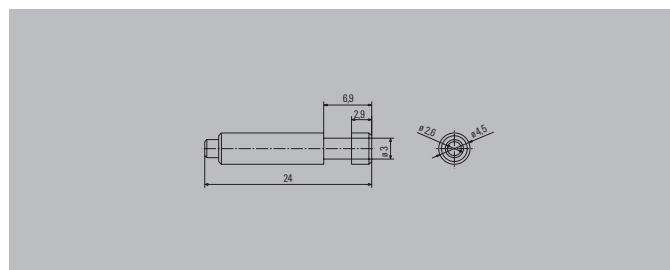

HQ 7 coding system

You can protect 7-pole HQ connectors against false insertions by using the HQ 7 coding system. Both a coding pin and socket are used for protection. Six different variants

are permitted by the shape of the optional coding which is aligned centrally in the connector. Refer to the coding diagram for the layout.

Ordering data

Type	Qty.	Order No.
HDC HQ 7 CPM	50	1003230000
HDC HQ 7 CPF	50	1003220000



Note:
Six-way coding is possible with a coding pin.

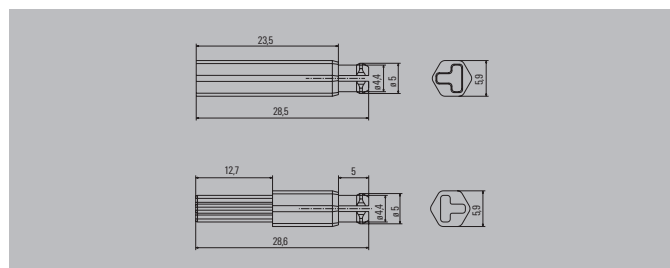

Coding arrangement Male/Female

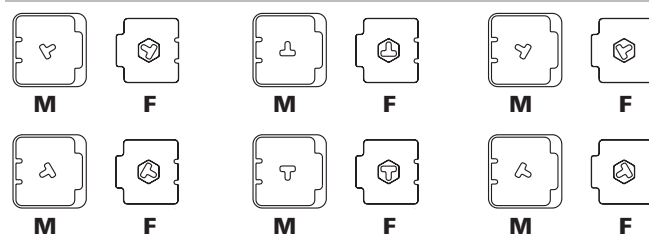

Shield lever

**Shield lever for sizes 3, 4, 6 and 8
for fitting of shield clamps or KLBÜ 3-8 SC**

Technical data

Use	Clamping of the shield
Fastening of shield lever	To PE terminal, both sides, 2nd screw for fixing
Cable connection system	Shield clamp or KLBÜ clamping yoke
No. shield clamps or KLBÜ clamping yokes	
Size 3	1*
Size 4	2*
Size 6	3*
Size 8	5*
Clamping range shield clamp	see page I.22
Material	Steel
Surface	Galvanised
Temperature range	-40 °C ... +125 °C
Note: *Fastening points of shield clamp, 16 mm spacing	

**Shield lever
for standard inserts**

HDC SHIELD LEVER 3 SC



Type	Size	Qty.	Order No.
HDC SHIELD LEVER 3 SC	3	1	1867390000

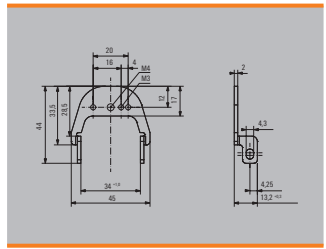

HDC SHIELD LEVER 4 SC



Type	Size	Qty.	Order No.
HDC SHIELD LEVER 4 SC	4	1	1867370000

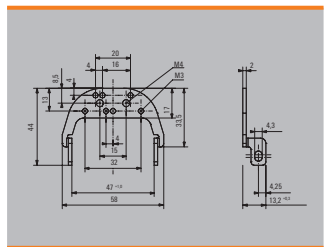

HDC SHIELD LEVER 6 SC



Type	Size	Qty.	Order No.
HDC SHIELD LEVER 6 SC	6	1	1867380000

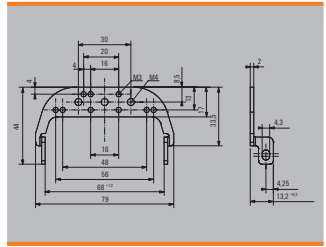

HDC SHIELD LEVER 8 SC



Type	Size	Qty.	Order No.
HDC SHIELD LEVER 8 SC	8	1	1867360000

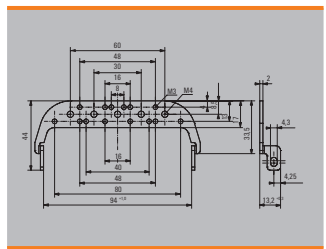

J

Shield lever

for standard inserts - special versions

SHIELD LEVER 8 MOD 35 mm



Type	Size	Qty.	Order No.
SHIELD LEVER 8 MOD 35mm	8	1	1000950001

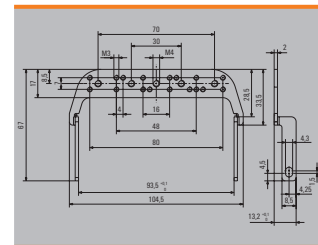

Shield lever

Special versions

HDC SHIELD LEVER 8 LL



Type	Size	Qty.	Order No.
HDC SHIELD LEVER 8 LL	8	1	1011380000

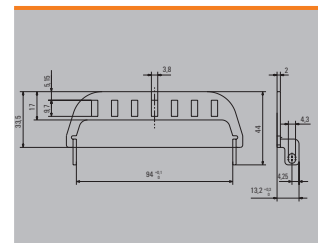

Shield lever

Shield lever

for the ModuPlug modular system (metal frame) - 45° angled version

HDC MSL6



Type	Size	Qty.	Order No.
HDC MSL6	3	1	1435410000

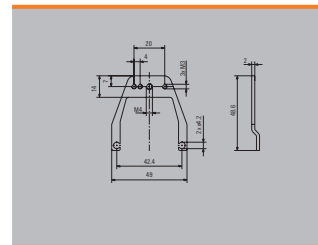

HDC MSL10



Type	Size	Qty.	Order No.
HDC MSL10	4	1	1435420000

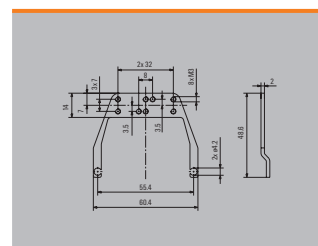

HDC MSL16



Type	Size	Qty.	Order No.
HDC MSL16	6	1	1435430000

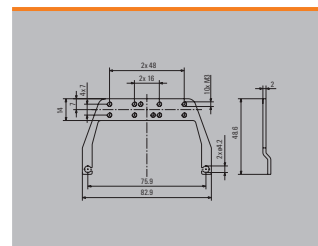

HDC MSL24



Type	Size	Qty.	Order No.
HDC MSL24	8	1	1435440000

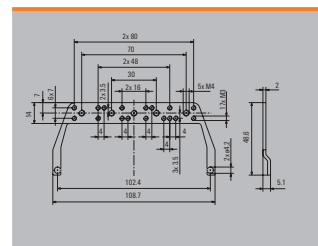

PE-Extension

for ModuPlug frames

HDC MF CA16 PE



Type	Size	Qty.	Order No.
HDC MF CA16 PE	16 mm ²	1	1480940000



HDC GRIP PANEL

Technical data

Use	KLBÜ and shield clamps can be used Cable ties can be used for fixing cable
Suitable for the series:	HE, HEE, HEEE HD, HDD HVE HSB ModuPlug
Material	Steel
Surface	Galvanised
Temperature range	-40 °C to 125 °C

Grip panel with screw adapter for fixed pole inserts

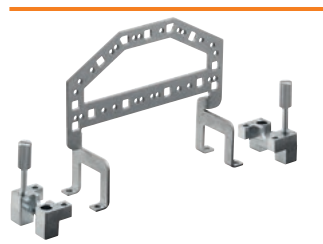

Type	Size	Qty.	Order No.
HDC GRIP PANEL 3 ADAPT	3	1	1444680000
HDC GRIP PANEL 4 ADAPT	4	1	1444710000
HDC GRIP PANEL 6 ADAPT	6	1	1444720000
HDC GRIP PANEL 8 ADAPT	8	1	1444730000

Grip panel with screw adapter for fixed-pole inserts and the modular system ModuPlug



Type	Size	Qty.	Order No.
HDC GRIP PANEL 3 ADAPT COM	3	1	2780770000
HDC GRIP PANEL 4 ADAPT COM	4	1	2780780000
HDC GRIP PANEL 6 ADAPT COM	6	1	2780790000
HDC GRIP PANEL 8 ADAPT COM	8	1	2780800000

Grip panel for fixed pole inserts and the modular system ModuPlug



Type	Size	Qty.	Order No.
HDC GRIP PANEL 3 COM	3	1	2782940000
HDC GRIP PANEL 4 COM	4	1	2782950000
HDC GRIP PANEL 6 COM	6	1	2782970000
HDC GRIP PANEL 8 COM	8	1	2782980000

Docking frame

Docking frame HDC MDF

Technical data

Application	For height compensation, for example with slide-in systems, the docking frames can be mounted floating on one or both sides.
Suitable for the series:	ModuPlug HE, HEE, HEEE HD, HDD, HVE HSB
Material	Stainless steel
Slide-in levelling, floating on one side	± 1 mm
Slide-in levelling, floating on both sides	± 2 mm
Tightening torque of the fastening screws	3.5 Nm

Size 3 (06B)



Type	Qty.	Order No.
HDC MDF 06B	1	2708490000

Size 4 (10B)



Type	Qty.	Order No.
HDC MDF 10B	1	2708500000

Size 6 (16B)



Type	Qty.	Order No.
HDC MDF 16B	1	2708510000

Size 8 (24B)



Type	Qty.	Order No.
HDC MDF 24B	1	2708520000

Other accessories

Shield clamps for shield levers of size 3 (06B), 4 (10B), 6 (16B) and 8 (24B)

Technical data

Use	Clamps shield on the shield lever	
Fastening of shield lever	With supplied fastening accessories	
Clamping range shield clamp	Cable diameter mm	Gauge of fastening holes mm
Shield clamp 10 mm	10	20
Shield clamp 9 mm	9	20
Shield clamp 8 mm	8	20
Shield clamp 7 mm	7	20
Shield clamp 6 mm	6	16
Shield clamp 5 mm	5	16
Shield clamp 4.5 mm	4.5	16
Material	Steel	
Surface	Galvanised	
Temperature range	-40 °C ... +125 °C	

Shield clamps



Type	Qty.	Order No.
SHIELD CLAMP 4.5 WO S	100	1018120000
SHIELD CLAMP 5 WO S	100	1018130000
SHIELD CLAMP 6 WO S	100	1018150000
SHIELD CLAMP 7 WO S	100	1018160000
SHIELD CLAMP 8 WO S	100	1018170000
SHIELD CLAMP 9 WO S	100	1018180000
SHIELD CLAMP 10 WO S	100	1018110000

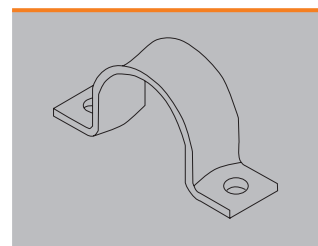

Shield clamps with fitting materials



Type	Qty.	Order No.
HDC SHIELD CLAMP 4.5	100	1912190000
HDC SHIELD CLAMP 5.0	100	1912200000
HDC SHIELD CLAMP 6.0	100	1912210000
HDC SHIELD CLAMP 7.0	100	1912220000
HDC SHIELD CLAMP 8.0	100	1912230000
HDC SHIELD CLAMP 9.0	100	1912240000
HDC SHIELD CLAMP 10.0	100	1912250000
HDC SHIELD CLAMP 14.0	100	1002820000

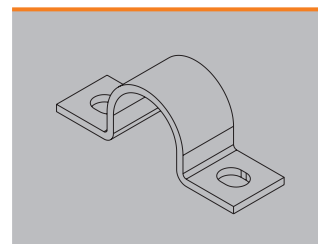

PE and mounting screws



Type	Qty.	Order No.
HDC PE HA SCREW M4x5,5	50	1025660000
HDC PE HE SCREW M4x7,8	50	1025670000
HDC PE HD/ HDD/CF SCREW M4x6	50	1029440000
HDC PE HSB/S SCREW M5x8	50	1029470000
HDC PE S6/6 SCREW M4x8	50	1029520000
HDC FIXING SC SIZE1 M3x6	50	1168850000
HDC FIXING SCREW M3x10	50	1029510000



Locking foot for TS 35 mounting rail

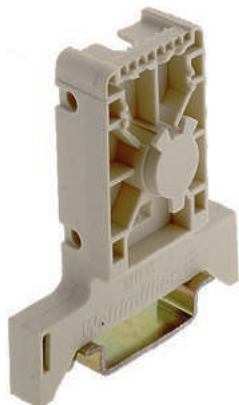

Locking hook

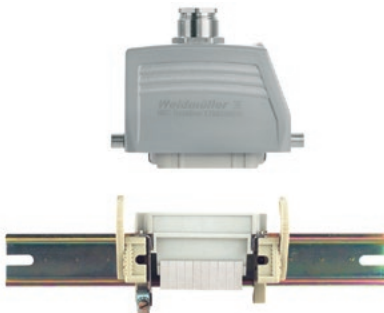

Example: DSTV-TS

Ordering data

Type	Qty.	Order No.
DSTV-TS 6-24	10	1595220000

Note:
For all inserts apart from HA and all inserts of size 1

Ordering data

Type	Qty.	Order No.
DSTV-TS 6 VH	10	1595230000
DSTV-TS 10-24 VH	10	1595240000

Note:
For all inserts apart from HA and all inserts of size 1



Other accessories

HDC screw adapter

The screw adapter is an IP20 installation solution with a full metal construction. The inserts are screwed into the screw adapters. The fastening screws for the inserts should be tightened with 0.5 Nm torque.

After the contact insert has been properly connected with the screw adapter, it can be mounted to the bulkhead or used as a mating connector, depending on the particular version. Three different screw adapters are possible based on the screw-in angle. The required mounting hardware is included.

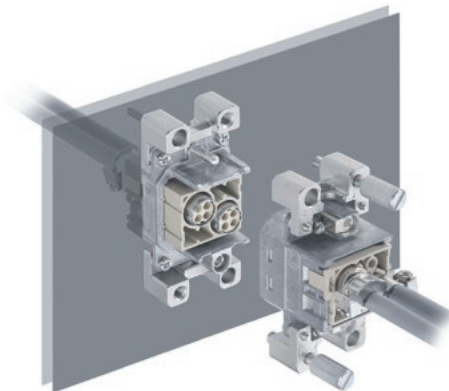

HDC ADAPTER W. SCREW



Type	Qty.	Order No.
HDC ADAPTER W. SCREW	1	1017010000

Note: Knurled screw interlock for the connector

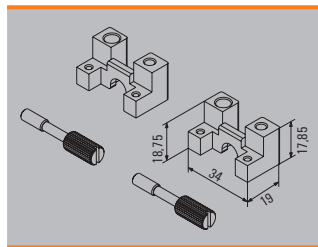

HDC SCREW ADAPTER



Type	Qty.	Order No.
HDC SCHRAUBADAPTER	1	1002790000

Note: Rectangular cut-out and M4 screws for mounting to wall panel; M3 screws for mounting the insert in the adapter

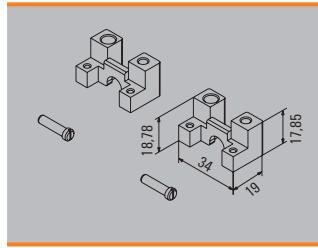

HDC SCREW ADAPTER W/O T



Type	Qty.	Order No.
HDC SCREW ADAPTER W/O T	1	1028030000

Note: Direct mounting on wall panel with rectangular cut-out and M3 screws

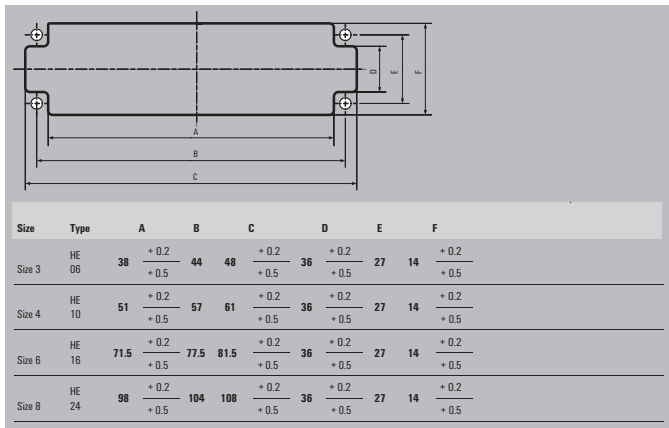
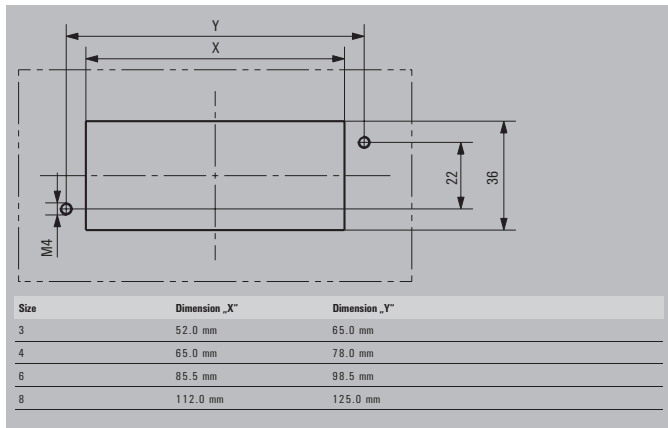
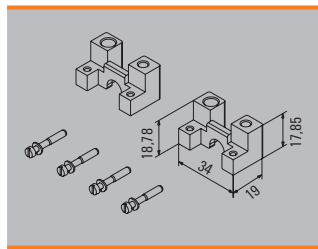

Adapter plates, plastic

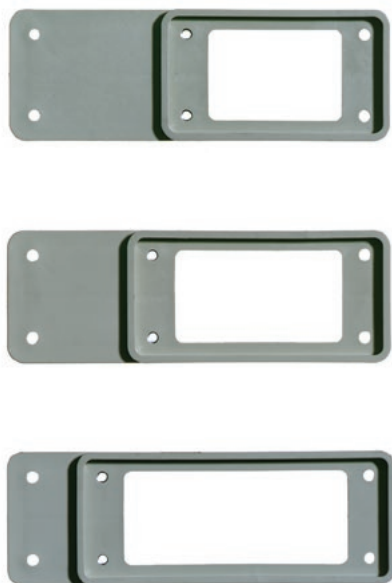

Technical data

Adapter plates, plastic	
Material	PA6
Sealing material	TPE-S
Colour	orange/grey
Temperature range	-30 °C to +110 °C
Class of protection	IP 65

Cover plates



Technical data

Cover plates	
Material	PA6 / FE
Sealing material	TPE-S
Colour	orange/grey
Temperature range	-30 °C to +110 °C
Class of protection	IP 65

Adapter plates, SUB-D



Technical data

Adapter plates, SUB-D	
Material	PA6
Sealing material	
Colour	grey
Temperature range	-30 °C to +110 °C
Class of protection	

Ordering data

Type	Size	Qty.	Order No.
orange			
ADP-8/3-OR	3	10	1664980000
ADP-8/4-OR	4	10	1665000000
ADP-8/6-OR	6	10	1665020000
grey			
ADP-8/3-GR	3	10	1664990000
ADP-8/4-GR	4	10	1665010000
ADP-8/6-GR	6	10	1665030000

Ordering data

Type	Size	Qty.	Order No.
Sheet steel			
ABD-1-Sheet steel	1	10	9457300000
Plastic, grey			
ABD-2-GR	2	10	1664330000
ABD-3-GR	3	10	1664350000
ABD-4-GR	4	10	1664360000
ABD-5-GR	5	10	1664370000
ABD-6-GR	6	10	1664390000
ABD-8-GR	8	10	1664970000
Plastic, orange			
ABD-8-OR	8	10	1664960000

Ordering data

Type	Aperture	Qty.	Order No.
Size 3 / Plastic			
ADS/6-1/9	1 x SUB-D 9	10	1665940000
ADS/6-2/9	2 x SUB-D 9	10	1665950000
ADS/6-1/15	1 x SUB-D 15	10	1666200000
ADS/6-2/15	2 x SUB-D 15	10	1666210000
Size 4 / Plastic			
ADS/10-1/25	1 x SUB-D 25	10	1666220000
ADS/10-2/25	2 x SUB-D 25	10	1666230000
Size 6 / Plastic			
ADS/16-1/25	1 x SUB-D 25	10	1666320000
ADS/16-2/25	2 x SUB-D 25	10	1666330000
ADS/16-1/37	1 x SUB-D 37	10	1666340000
ADS/16-2/37	2 x SUB-D 37	10	1666350000
ADS/16-1/50	1 x SUB-D 50	10	1666460000

Other accessories

Profile seals

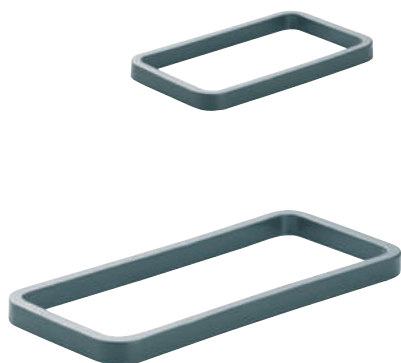

Gaskets



Seals

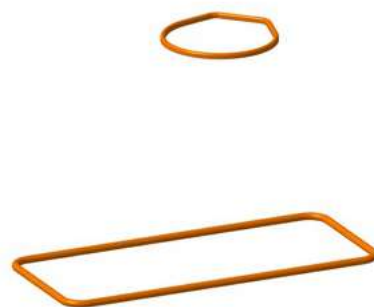

J

Ordering data

Type	Size	Qty.	Order No.
HDC DG 07A	1	5	1044580000
HDC DG 10A	2	5	1044590000
HDC DG 06B	3	5	1044610000
HDC DG 10B	4	5	1044620000
HDC DG 16A	5	5	1044600000
HDC DG 16B	6	5	1044630000
HDC DG 32A	7	5	1044640000
HDC DG 24B	8	5	1044650000
HDC DG 48A 32B	9/10	5	1044660000
HDC DG 48B	12	5	1044670000

Note:
for bulkhead and coupling housings

Ordering data

Type	Size	Qty.	Order No.
HDC FLDG 04A	1	5	1044480000
HDC FLDG 10A	2	5	1044490000
HDC FLDG 06B	3	5	1044500000
HDC FLDG 10B	4	5	1044510000
HDC FLDG 16A	5	5	1044520000
HDC FLDG 16B	6	5	1044530000
HDC FLDG 32A	7	5	1044540000
HDC FLDG 24B	8	5	1044550000
HDC FLDG 32B	10	5	1044560000
HDC FLDG 48B	12	5	1044570000
HDC-HB10 AWVL FD	HB-10 AWVL 500		1855680000

Note:
for bulkhead housings

Ordering data

Type	Size	Qty.	Order No.
HDC FLDG 04A AW IP68		10	1987470000
HDC FLDG 04A IP68		10	1987450000
HDC FLDG 06B IP68		10	1987480000
HDC FLDG 10B IP68		10	1987500000
HDC FLDG 16B IP68		10	1987520000
HDC FLDG 24B IP68		10	1987540000
HDC FLDG 24B XXL IP68		10	1987550000
HDC DG 04A IP68		10	1987460000
HDC DG 06B IP68		10	1987490000
HDC DG 10B IP68		10	1987510000
HDC DG 16B IP68		10	1987530000
HDC DG 24B IP68		10	1525270000
HDC DG 24B XXL IP68		10	1987570000

Note:
for bulkhead housings

Protective transportation cap for IP65 housings

The protective transportation caps are available for sizes 3, 4, 6 and 8. They can be used with the IP65 standard housings. The transportation caps are easy to attach and provide IP20 protection. They can be used with all bottom housing sections, bulkhead housings or base housings. A lanyard (not included) can be threaded through the built-in eyelet.

Technical data

Material	Polypropylene
UL94	HB
Colour	white/transparent
Temperature range	-55 °C ... +110 °C
Class of protection	IP20

Protective transportation cap for IP65 housings

HDC 06B DC



Type	Qty.	Order No.
HDC 06B DC	10	1215900000

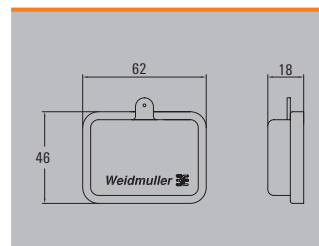

HDC 10B DC



Type	Qty.	Order No.
HDC 10B DC	10	1215910000

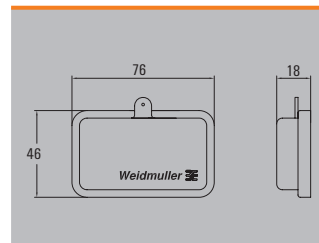

HDC 16B DC



Type	Qty.	Order No.
HDC 16B DC	10	1215920000

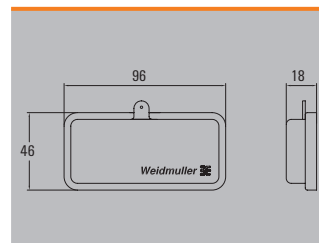

HDC 24B DC



Type	Qty.	Order No.
HDC 24B DC	10	1215930000

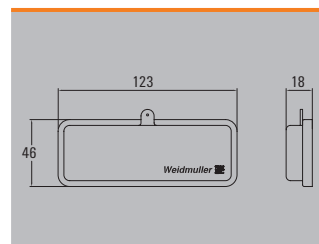

Cutting

Hydraulic sheet holes

Incl. accessories:

- 1 HSS pre-drill Ø 10 mm
- 1 tension bolt Ø 19 mm
- 1 tension bolt Ø 19 x 9.5 mm
- 1 spacer nut set (3-part)
- 1 bridge

IE-KO-HAT



- Pressure relief valve protects against overloading
- Cylinder head angled at 90°
- Angled head can be rotated through 360°
- Ergonomic handle springs back automatically
- The waste piece no longer becomes jammed thanks to 3-fold splitter
- Hydraulic punch made of high-strength aluminium (approx. 40% weight saving)
- Service life greatly reduced when stainless steel sheets are used

KOK



- Rectangular splitting stamp for heavy-duty connectors

J

Technical data

Maximum steel-sheet punching performance
Round holes from 1 to Ø 85 mm
Round holes from 2 to Ø 64 mm
Square holes up to
Rectangular holes up to
Maximum stainless steel sheet punching performance
Round holes from 3 to Ø 64 mm
Tool data
Depth / Width / Height
Weight
Punching force
Max. operating pressure
Note

IE-KO-HAT
2,0 mm F = 370 N/mm ²
3,0 mm F = 370 N/mm ²
68 x 68 mm; 2,0 mm F = 370 N/mm ²
36 x 112 mm; 2,0 mm F = 370 N/mm ²
2,5 mm F = 600 N/mm ²
70 / 290 / 120 mm
1,9 kg
75 kN
650 bar

Ordering data

Version
Note

Type	Qty.	Order No.
IE-KO-HAT	1	1966810000

Accessories

Tension bolt
Tension bolts
Pre-drill
Note

Type	Qty.	Order No.
KOHS 19	1	9205010000
KOHS 9.5+19	1	9205000000
KOPD 10.0	1	9205020000

Type	Description	Qty.	Order No.
KOK 52 x 36	6-pole	1	9204820000
KOK 65 x 36	10-pole	1	9204830000
KOK 86 x 36	16-pole	1	9204850000
KOK 112 x 36	24-pole	1	9204870000

Note: the fastening points are centre-punched.

Crimping tools for other contacts

- Ratchet for precise crimping
- Release option in the event of incorrect operation
- With end stop for exact positioning of the contacts

CTX CM 1.6/2.5 / CTX CM 3.6

0.14...10 mm²

CTX CM 1.6/2.5

- Turned HD contacts
- Turned HE contacts
- ConCept M10 and M5 contacts
- ~AWG 26...12
- 0.14...4.0 mm²

CTX CM 3.6

- Turned HD contacts
- ConCept M3 contacts
- ~AWG 12...8
- 4.0...10 mm²



CTIN CM 1.6/2.5 / CTIN 3.6

0.14...10 mm²

CTIN CM 1.6/2.5

- Turned HD and HE contacts
- Turned HX contacts
- ConCept M10, M5 and M3 contacts
- 4-indent crimp
- ~AWG 26...10
- 0.14...6.0 mm²

CTIN CM 3.6

- Turned HX contacts
- ConCept M3 contacts
- 4-indent crimp
- ~AWG 16...8
- 1.5...10 mm²



Technical data

Description of contact
Type of contact
Crimping range
Crimping range 1 (with multiple crimping positions)
Crimping range 2 (with multiple crimping positions)
Crimping range 3 (with multiple crimping positions)
Crimping range 4 (with multiple crimping positions)
Crimping range 5 (with multiple crimping positions)
Tool data
Width
Weight
Note

Ordering data

Version
Note

CTX CM 1.6/2.5	CTX CM 3.6
Turned contacts	Turned contacts
0.14 mm ² ...4 mm ²	4 mm ² ...10 mm ²
0.14 mm ² ...0.5 mm ²	4 mm ²
0.75 mm ² ...1 mm ²	6 mm ²
1.5 mm ²	10 mm ²
2.5 mm ²	
4 mm ²	
250 mm	250 mm
730 g	730 g

Type	Qty.	Order No.
CTX CM 1.6/2.5	1	9018490000
CTX CM 1.6/2.5 ZERT	1	9013690000
CTX CM 3.6	1	9018480000
CTX CM 3.6 ZERT	1	1270320000

CTIN CM 1.6/2.5	CTIN CM 3.6
Turned contacts	Turned contacts
0.14 mm ² ...6 mm ²	1.5 mm ² ...10 mm ²
0.14 mm ² ...6 mm ²	1.5 mm ² ...10 mm ²
230 mm	230 mm
1220 g	1220 g

Type	Qty.	Order No.
CTIN CM 1.6/2.5	1	9205430000
CTIN CM 3.6	1	9205440000

Crimping

Crimping tools for HighPower

Crimping tools for HighPower 250 A / 550 A

EPG 45 hydraulic battery crimping tool



Type	Order No.
EPG 45	1500830000

Hexagonal crimp inserts for EPG 45



Identification number	Cu mm ²	Al mm ²	Crimping width, mm	Type	Order No.
5	6		7	ES EPG 45 HEX 6	1500930000
6/16	10/70	-/50	7/5	ES EPG 45 HEX 10/70	1500940000
8/12	16/35	-/16+25	12/10	ES EPG 45 HEX 16/35	1500950000
10/14	25/50	10/35	12/5	ES EPG 45 HEX 25/50	1500970000
18	95	70	5	ES EPG 45 HEX 95	1500980000
20	120		5	ES EPG 45 HEX 120	1500990000
22	150		5	ES EPG 45 HEX 150	1994540000

APG 80 hydraulic battery crimping tool



Type	Order No.
APG 80	1502390000

Hexagonal crimp inserts for APG 80



Identification number	Cu mm ²	Al mm ²	Crimping width, mm	Type	Order No.
5	6		7	ES APG 80 HEX 6	1502600000
6	10		7	ES APG 80 HEX 10	1502620000
8	16		12	ES APG 80 HEX 16	1502630000
10	25	16	12	ES APG 80 HEX 25	1502640000
12	35	25	12	ES APG 80 HEX 35	1502650000
14	50	35	12	ES APG 80 HEX 50	1502670000
16	70	50	12	ES APG 80 HEX 70	1502680000
18	95	70	10	ES APG 80 HEX 95	1502690000
20	120		10	ES APG 80 HEX 120	1502700000
22	150	95+120	5	ES APG 80 HEX 150	1502720000
25	185	150	5	ES APG 80 HEX 185	1502730000
28	240	185	5	ES APG 80 HEX 240	1502740000
32	300	240	7	ES APG 80 HEX 300	1502750000
32		300	7	ES APG 80 HEX 300AL	1502780000

HTX-HDC/POF**POF crimping**

Crimping of "polymer optical fibre" (POF) fibre-optical contacts.

- For plug and socket
- Ratchet for precise crimping
- Unlocks in case of incorrect operation
- Locator for precise contact positioning

Contacts:

- Fibre-optic cable HD contact socket for Ø1.0 mm POF
- Fibre-optic cable HD contact pin for Ø 1.0 mm POF

Ordering data

Type	Qty.	Order No.
HTX-HDC/POF	1	9010950000

Technical data

Depth	
Weight	438 g

**PB LWL/POF / PS LWL/POF****POF polishing**

For processing the cut surface of fibre-optic cables with polymer optical fibre (POF).

- Buffing disc (PS LWL/POF)
- Buffing sheet (PB LWL/POF)

Ordering data

Type	Qty.	Order No.
PB LWL/POF	1	9020400000
PS LWL/POF	1	9020390000

**AM LWL/POF****POF stripping**

Stripping fibre-optic cables. Fibre-optic cable with polymer optical fibres (POF).

- Longitudinal stop with scale is built into the tool
- Stripping direction is lengthwise to the fibre
- No damage to the optical fibre

Ordering data

Type	Qty.	Order No.
AM LWL/POF	1	9020360000

**LWL-stripax®**

Stripping and cutting tool for plastic fibre-optic cables with 1 mm diameter inner conductor

- Stripping length adjustable via end stop
- Automatic opening of the clamping jaws after stripping

Ordering data

Type	Qty.	Order No.
M-D-STRIPAX LWL	1	9003750000



Screwdrivers

Uninsulated torque screwdrivers

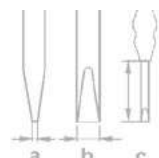

DMS manual

Torque screwdriver
EN ISO 6798, BS EN 26789, ASME B107.14M



Type	Size / AF	a	b	c	Order No.
DMS MANUELL 0,5-1,7					9918370000
DMS MANUELL 2,0-7,0					9918380000

WK S

Interchangeable bits for torque screwdrivers
Drive output acc. to DIN 5264, ISO 2380/1



WK S 0,4X2,5	0.4	2.5	175	9918520000
WK S 0,5X3,0	0.5	3	175	9918530000
WK S 0,6X3,5	0.6	3.5	175	9918540000
WK S 0,8X4,0	0.8	4	175	9918550000
WK S 1,0X5,5	1	5.5	175	9918560000

WK K PZ

Interchangeable bits for torque screwdrivers
Drive output acc. to DIN 5260-PZ, ISO 8764/1-PZ



WK K PZ0			175	9918600000
WK K PZ1			175	9918610000
WK K PZ2			175	9918620000

WK K PH

Interchangeable bits for torque screwdrivers
Drive output acc. to DIN 5260-PH, ISO 8764/1-PH



WK K PH0			175	9918570000
WK K PH1			175	9918580000
WK K PH2			175	9918590000

WGK 1/4 C.6.3 E6.3

Interchangeable bit with bit holder for torque screwdrivers
Drive output: 1/4" C6.3 and 1/4" E6.3

Note: matching bits on page F.9



WGK 1/4 C6,3 E6,3				9202510000
-------------------	--	--	--	------------

VDE-insulated torque screwdrivers

VDE-insulated torque screwdrivers

VDE-insulated torque screwdriver
EN ISO 6798, BS EN 26789, ASME B107.14M



Bit holder



VDE slimBit Schlitz



VDE slimBit Phillips



VDE slimBit Pozidrive PZ



VDE slimBit Torx



VDE slimBit Robertson



VDE slimBit Hex

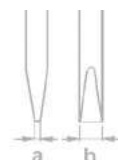

Type	Size / AF	a	b	Order No.
DMSI MANUELL 0,5-1,7				9918390000
DMSI MANUELL 2,0-7,0				9918400000

WK I SLIM BIT	2489300000
---------------	------------

WB SI SL 0,8X4,0	0.8	4	2433190000
WB SI SL 0.4X2.5	0.4	2.5	2433160000
WB SI SL 0.5X3.0	0.5	3	2433170000
WB SI SL 0.6X3.5	0.6	3.5	2433180000
WB SI SL 1,0X5,5	1	5.5	2433200000

WB IK SL PH1	2433210000
WB IK SL PH2	2433220000

WB IK SL PZ1	2433230000
WB IK SL PZ2	2433240000

WB I T10	2506000000
WB I T15	2506010000
WB I T20	2506020000

WB I VK 1	2506030000
WB I VK 2	2506040000

WB I SK 2.5	2506050000
WB I SK 3	2506060000
WB I SK 4	2506070000
WB I SK 5	2506080000

Screwdrivers

Uninsulated screwdrivers

Weidmüller screwdrivers for general applications. Bit made of high-quality chrome-silicon vanadium steel, matt-chrome finish.

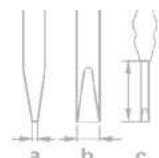

SDS

Slotted screwdriver with rounded blade, SD DIN 5265, DIN ISO 2380, drive output acc. to DIN 5264, DIN ISO 2380/1, ChromTop tip



Type	Size / AF	a	b	c	Order No.
SDS 0.4X2.0X60		0.4	2	60	2749260000
SDS 0.4X2.5X75		0.4	2.5	75	2749320000
SDS 0.5X3.0X80		0.5	3	80	2749330000
SDS 0.6X3.5X100		0.6	3.5	100	2749340000
SDS 0.6X3.5X200		0.6	3.5	200	2749350000
SDS 0.8X4.0X100		0.8	4	100	2749360000
SDS 0.8X4.5X125		0.8	4.5	125	2749370000
SDS 1.0X5.5X150		1	5.5	150	2749380000
SDS 1.2X6.5X150		1.2	6.5	150	2749390000

SDK PH

Crosshead screwdriver, Phillips, SDK PH DIN 5262, DIN ISO 8764-PH, drive output acc. to DIN ISO 8764-PH, chrome top tip



SDK PH0 X 60	60	2749400000
SDK PH1 X 80	80	2749410000
SDK PH2 X 100	100	2749420000
SDK PH3 X 150	150	2749430000

SDK PZ

Crosshead screwdriver, Pozidriv, SDK PZ DIN 5262, DIN ISO 8764-PZ, drive output acc. to DIN ISO 8764-PZ, chrome top tip



SDK PZ1 X 80	80	2749440000
SDK PZ2 X 100	100	2749450000
SDK PZ3 X 150	150	2749460000

SD TR

Torx® TR-screwdriver with hole in tip of blade (tamper-resistant), SD TR for screwing Torx® and Torx®TR security screws (pin in centre of Torx® recess), ChromTop tip



SD T7 TR X 60	60	2749470000
SD T8 TR X 60	60	2749480000
SD T9 TR X 60	60	2749490000
SD T10 TR X 80	80	2749500000
SD T15 TR X 80	80	2749510000
SD T20 TR X 100	100	2749520000
SD T25 TR X 100	100	2749530000
SD T30 TR X 115	115	2749540000
SD T40 TR X 115	115	2749550000

SD TO

Angled slotted screwdriver with round handle



SD TO 0,4X2,5	0.4	2.5	70	2749570000
SD TO 0,6X3,0	0.6	3	70	2749560000

Uninsulated screwdrivers

Weidmüller screwdrivers for general applications. Bit made of high-quality chrome-silicon vanadium steel, matt-chrome finish.



SD SET S2.5-5.5/PH1/2

6-piece set: slotted and crosshead PH screwdriver set with circular blades, DIN ISO 2380 und DIN ISO 8764



Type	Size / AF	a	b	c	Order No.
SDS 0.4X2.5X75		0.4	2.5	75	
SDS 0.5X3.0X80		0.5	3	80	
SDS 0.8X4.0X100		0.8	4	100	
SDS 1.0X5.5X150		1	5.5	150	
SDK PH1 X 80				80	
SDK PH2 X 100				100	
SD SET S2.5-5.5/PH1/2					2749200000

SD SET S2.0-5.5

6-piece set: slotted screwdriver set, DIN ISO 2380



SDS 0.4X2.0X60		0.4	2	60	
SDS 0.4X2.5X75		0.4	2.5	75	
SDS 0.5X3.0X80		0.5	3	80	
SDS 0.6X3.5X100		0.6	3.5	100	
SDS 0.8X4.0X100		0.8	4	100	
SDS 1.0X5.5X150		1	5.5	150	
SD SET S2.0-5.5					2749220000

SD Set T10/15/20/25/30/40 TR

6-piece set: Torx® TR screwdriver set



SD T10 TR X 80				80	
SD T15 TR X 80				80	
SD T20 TR X 100				100	
SD T25 TR X 100				100	
SD T30 TR X 115				115	
SD T40 TR X 115				115	
SD SET T10/15/20/25/30/40 TR					2749230000

Screwdrivers

Pico screwdrivers

SD EL S PICO

Weidmüller precision screwdriver, slotted



SD EL PZ PICO

Weidmüller precision screwdriver, cross recess type Pozidriv, PZ 8764



SD EL PH PICO

Weidmüller precision screwdriver, cross recess type Phillips, PH 8764



SD EL SET 1.5-4.0/PH0/1

7-piece set: Precision screwdriver slotted and cross-slotted PH



Type	Size / AF	a	b	c	Order No.
SD EL 0.3X1.5X40 PICO		0.3	1.5	40	2750060000
SD EL 0.4X2.0X60 PICO		0.4	2	60	2750070000
SD EL 0.4X2.5X75 PICO		0.4	2.5	75	2750080000
SD EL 0.5X3.0X75 PICO		0.5	3	75	2750090000
SD EL 0.6X3.5X100 PICO		0.6	3.5	100	2750100000
SD EL 0.8X4.0X100 PICO		0.8	4	100	2750110000

SDK EL PZO X 60 PICO	60	2750120000
SDK EL PZ1 X 80 PICO	80	2750130000

SDK EL PH0 X 60 PICO	60	2750140000
SDK EL PH1 X 80 PICO	80	2750150000

SD EL 0.3X1.5X40 PICO	0.3	1.5	40	
SD EL 0.4X2.0X60 PICO	0.4	2	60	
SD EL 0.4X2.5X75 PICO	0.4	2.5	75	
SD EL 0.5X3.0X75 PICO	0.5	3	75	
SD EL 0.8X4.0X100 PICO	0.8	4	100	
SDK EL PH0 X 60 PICO			60	
SDK EL PH1 X 80 PICO			80	
SD EL SET 1.5-4.0/PH0/1				2750160000

Weidmüller Allen key set

Socket wrench manufactured from through-hardened chromium-vanadium steel, manufactured according to DIN ISO 2936 L (DIN 911), high-quality finished surface.

SK WSD S

9-piece offset Allen key set in the Prostar, with MagicRing: tightly holds standard screws in any position thanks to its spring steel ring (up to size 3), with ball head for screwing up to an angle of 25°.



Type	Size / AF	a	b	c	Order No.
	1.5				
	2				
	2.5				
	3				
	4				
	5				
	6				
	8				
	10				
SK WSD-S 1,5-10,0					9008850000

SK S

7-piece Allen key set



SKS 2,0-8,0					9008860000

SK S MR

7-piece Allen key set with ball head and MagicRing: holds standard screws (size 3 and larger) in any position thanks to its spring steel ring, with ball head for screwing up to an angle of 25°.



SKS 2,0-8,0 MR					9008870000

TH S

8-piece Torx®-TH Allen key set with hole in the bit tip (tamper-resistant), for screwing Torx® and Torx®-TH security screws (pin in centre of Torx® recess)



TH-S 9-40					9008880000

Miscellaneous

Removal Tool CM3, CM5, HD

Removal tool HD

CM3 Removal Tool

Contact release tool for freeing crimp contacts in the Concept CM3 module

CM5 Removal Tool

Contact release tool for freeing crimp contacts in the Concept CM5 module

HD Removal Tool

Contact release tool for freeing crimp contacts in the Concept CM10 module

Ordering data

Type	Qty.	Order No.
REMOVAL TOOL CM 3	1	1866710000
REMOVAL TOOL CM 5	1	1866720000
REMOVAL TOOL HD	1	1866730000



Removal Tool CM20

Removal Tool CM 20

Contact release tool for freeing crimp contacts in the Concept CM20 module

Ordering data

Type	Qty.	Order No.
REMOVAL TOOL CM 20	1	1866740000



Removal Tool HE

Removal Tool HE

Contact release tool for the ConCept HE module and for releasing crimp contacts in the ConCept CM4 module

Ordering data

Type	Qty.	Order No.
REMOVAL TOOL HE	1	1866750000



HDC-DW RSV 1.6

Contact release tool for the ConCept module, or for dismantling stamped HD pin and socket contacts of type CB/CS and GB/GS

Ordering data

Type	Qty.	Order No.
DW RSV 1.6	1	9004530000



Removal Tool AFK

Contact release tool for loosening FEKO ZRV contacts.

Ordering data

Type	Qty.	Order No.
REMOVAL TOOL AFK	1	1866760000



Replacement sleeve for contact release tool

Ordering data

Type	Qty.	Order No.
HÜLSE REMOVAL TOOL HD	5	1044100000
HÜLSE REMOVAL TOOL CM 3	5	1044080000
HÜLSE REMOVAL TOOL CM 5	5	1044090000



CA 100/104...10 mm²

The CA 100/10 is an electropneumatic powered automatic stripper and crimper for time-saving and rational processing of loose wire end ferrules. It has been developed for the assembly of medium series cables in stationary areas. The automatic machines feature quick and easy handling.

- Stripping and crimping in one operation
- Electropneumatic drive
- Stripping and crimping in a range of 4 to 10 mm² (AWG 12 - 8)
- Processing of wire end ferrules of various crimping length
- Quick and easy retooling
- Oscillating conveyor to hold loose wire end ferrules
- Optional processing of wire end ferrules without plastic collar possible

Technical data

	CA 100/10
Crimping range	4 ... 10 mm ² (AWG 12...8) (with usage of the respective tool set)
Crimping lengths	6...18 mm
Connection	100 - 240 V / 50 - 60 Hz / 100 VA
Drive	Electropneumatic
Compressed-air connection	5 - 5.5 bar
Pulse time	approx. 2.5 sec.
Crimping	Trapezoidal crimp
Dimensions W x D x H (mm)	530 x 400 x 460
Weight	40 kg
Options	Quadrocrimp tool: for a perfectly square four-sided crimp

Ordering data

Type	Qty.	Order No.
CA 100/10	1	on request

Note on ordering

In order to precisely determine the required conversion tool, you will need the exact specifications for both the wire end ferrules being processed and the cables being processed.

CA Indent0.14...2.5 mm²

The CA Indent is an electro-pneumatic-driven automatic stripper and crimper for processing loose-packed, turned male and female contacts. The contacts are fed automatically via an oscillating conveyor set-up. Conductors and contacts in the 0.34 ... 2.5 mm² range (AWG 22 to 14) can be crimped normally with a indent crimp shape, in compliance with MIL C-22520/1-01. The settings for stripping and crimp depth are motor-driven. The values can be saved in 50 different programs. The keyboard is used for configuration and programming. Important data, functions and errors are shown on the LCD display. With the help of the appropriate tools, the automatic crimper may be converted to various contacts and/or conductors.

- Stripping and crimping in one operation
- Electro-pneumatic drive
- Strips and crimps 0.14 - 2.5 mm² (AWG 26-14)
- Processes loose twisted pin and socket contacts
- Weidmüller HDC-C-HD/HE contacts further contacts on request
- Rapid and simple change-over
- Vibration-feeder takes 500 loose machined contacts
- Indent crimp conforms with MIL C-22520/1-01
- Program memory for 50 contact variations
- Stripping and crimping dimensions adjusted by means of electric motor

Technical data

	CA Indent
Stripping range	0.14 ... 2.5 mm ² / (AWG 26-14)
Connection	100 - 240 V / 50 - 60 Hz / 185 VA
Drive	pneumatic
Compressed air connection	5 - 5.5 bar
Processing time	approx. 2.5 s
Size W x D x H	450 x 490 x 420
Weight	40 kg

Ordering data

Type	Qty.	Order No.
CA Indent	1	on request

Note on ordering

The machine is set up using sample contacts to suit the user's requirements. For this we need the name of the manufacturer, the type designation and the cross-sections of the contacts.

Detailed quotation available on request.

Cable entries

Weidmüller offers a variety of add-on components for a multitude of purposes and applications to complement its extensive Klippon® Protect range.

In addition to brass, plastic and stainless steel cable glands, there are also sealing plugs, pressure-equalising elements, adapters and relevant accessories – such as lock nuts, flat gaskets, flat washers and earthing rings – available.

To match the assembled enclosures, the cable glands meet the requirements of IP protection classes IP54 to IP69K. They can be used in standard industrial applications, EMC applications or even in potentially explosive atmospheres as required, and they comply with the approvals required for these purposes.

Ex-certified cable glands also allow for the connection of cables and conductors with different reinforcements with and without lead sheathing, as well as the connection of steel wire and steel tape cables. They can also be used in a temperature range of between -50 °C and +120 °C.

Depending on the cable gland variants and application, the cable glands, sealing plugs, adaptors, pressure-equalising elements and accessories are manufactured and certified according to the following standards:

- IEC/EN 62444 (construction and performance)
- IEC/EN 60529 (IP protection class testing)
- IEC/EN 60079-0 (general Ex requirements)
- IEC/EN 60079-1 (Ex d Ex standard)
- IEC/EN 60079-7 (Ex e Ex standard)
- IEC/EN 60079-11 (Ex i Ex standard)
- IEC/EN 60423 (metric screw thread)
- DIN 40430 (PG and NPT thread)

The range of cable glands, sealing plugs and pressure-equalising elements is available in metric (M) and high-strength (PG) threads in sizes ranging from M12 to M75 and PG7 to PG48. When choosing cable glands and sealing plugs, please refer to the table with the sealing characteristics of the O-rings, flat gaskets and seal inserts. O-rings and flat gaskets are always intended for sealing the connecting thread on an enclosure, for example, while the sealing insert of each cable gland is intended for actually sealing and clamping the connecting cable.

J



You can find this product family
in our Weidmüller Configurator:

www.weidmueller.com/wmc

You should always observe the maximum drill-hole diameter when installing a cable gland, sealing plug, adaptor, or pressure compensation element (e.g. onto the gland plate of an enclosure). These must not exceed the following specified maximum values / tolerances so that the protection degree of the whole enclosure can be guaranteed. Please also refer to the instruction manual; deviating information is possible.

Through-hole information

M thread	Through-hole, in mm
M 12	12.2
M 16	16.2
M 20	20.2
M 25	25.2
M 32	32.2
M 40	40.2
M 50	50.2
M 63	63.2
M 75	75.2
PG thread	Through-hole, in mm
PG 7	12.4
PG 9	15.1
PG 11	18.5
PG 13.5	20.4
PG 16	22.5
PG 21	28.3
PG 29	37.4
PG 36	47.2
PG 42	54.2
PG 48	59.5

Overview of sealing materials for O-rings, flat gaskets as well as seal inserts

Abbreviation	Material	Trade name	Temperature range	Chemical resistance	Fire resistant	Shore	Free from halogens	UV resistance
TPE	Thermo-plastic elastomer	Santoprene	-40 °C to +130 °C	Hydrocarbons, oils, acids	UL94, HB	64	Yes	very good
CR	Chloroprene rubber	Neoprene	-40 °C to +130 °C	Mineral oils, greases, fuels	very good	40 - 90	No	very good
NBR	Nitrile rubber	Perbunan, Nitrile	-40 °C to +130 °C	Hydrocarbons, oils, acids, aliphatic solvents, greases, fuels	weak	40 - 90	No	good
EPDM	Ethylene-propylene-diene rubber	Keltan	-50 °C to +130 °C	Weather-, grease-, mineral oil-, chlorine-, and ozone resistant, hydrocarbons	weak	20 - 90		very good
FPM	Fluoro-rubber	Viton	-25 °C to +200 °C	ozone, oxygen, mineral oils, synthetic hydraulic fluids, fuels, aromatics, many organic solvents and chemicals	weak	65 - 95		good

Note: The data refer only to the sealing material, not to the entire component.

Abbreviations - technical data

A, L	Length in mm
L1	Length of thread in mm
D	Diameter in mm
S	Thickness in mm
S1, S2	Depth in mm
SW, SW1, SW2	Distance across flats in mm
KB	Clamping range in mm
KB ZE	Clamping range strain relief in mm
Thread	External thread
SUHB	Shroud / Protective cap
DR	Tightening torque in Nm
HM	Cap nut / pressure screw
Qty.	Packing unit in pieces

Product designation

VP HEX	Sealing plugs with hexagon head
A2L	Ex Cable gland
A2LC	Ex Cable gland with conduit connection thread
E1W	Ex Cable Gland with double sealing for SWA armoured cable
E1XZ	Ex Cable Gland with double sealing for SWB/STA armoured cable
VG	Cable gland
VP	Sealing plugs
SKMU	Hexagon nut
DAE	Pressure compensation element
BD	Breather drain (compensation element)
SZS	Serrated Star Washers (Serrated washers)
ZE	Strain relief
EMV	Electromagnetic compatibility
EA	Earthing ring
SKS	Spiral kink protection
GWDR	Thread sealing ring or flat gasket

Standard cable glands – Plastic

Cable glands – Plastic – IP68



Cable gland made of plastic with integrated strain relief for industrial applications where IP67 or IP68 protection is required. Tested and approved according to EN 62444 and UL514B.

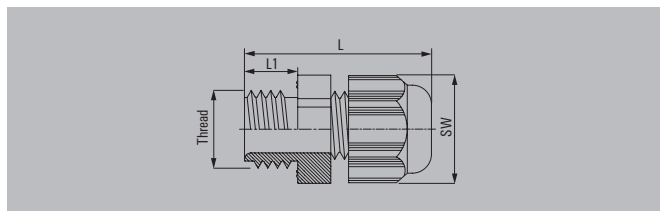

Technical data

Material / Colour	Polyamide 6 / Light Grey / RAL 7035
Seal insert	CR
Temperature range	-40 °C...100 °C
Protection class	IP67, IP68 - 5 bar (30 min.)
Flammability rating	V-2
Note	Version with moulded sealing lip. Length L varies depending on the cable diameter used.

Ordering data

Type	Thread	KB	L/L1	SW	Qty.	Order No.
metric						
VG M12-1/K68	M 12	3-6.5	30.5 / 8	15	100	1772280000
VG M16-1/K68	M 16	4-8	34.5 / 8	19	50	1909860000
VG M16 - K 68	M 16	5-10	40 / 10	22	50	1772290000
VG M20-1/K68	M 20	6-12	39.5 / 10	24	50	1772300000
VG M25-1/K68	M 25	11-17	43 / 8	29	50	1909870000
VG M25 - K 68	M 25	13-18	47 / 10	33	25	1772310000
VG M32-1/K68	M 32	15-21	52 / 10	36	20	1909880000
VG M32 - K 68	M 32	18-25	56 / 15	42	20	1772320000
VG M40-1/K68	M 40	19-28	57 / 10	46	10	1909890000
VG M40 - K 68	M 40	22-32	69.5 / 18	53	10	1772330000
VG M50 - K 68	M 50	30-38	71 / 18	60	10	1772340000
VG M63-1/K68	M 63	34-44	71 / 18	65	10	1772350000
PG						
VG 7-K68	PG 7	3-6.5	30 / 8	15	100	1568970000
VG 9-K68	PG 9	4-8	34.5 / 8	19	50	1568980000
VG 11-K68	PG 11	5-10	37 / 8	22	50	1568990000
VG 13.5-K68	PG 13.5	6-12	39 / 10	24	50	1569000000
VG 16-K68	PG 16	10-14	41 / 10	27	50	1569010000
VG 21-K68	PG 21	13-18	48 / 11	33	25	1569020000
VG 29-K68	PG 29	18-25	52 / 11	42	20	1569030000
VG 36-K68	PG 36	22-32	64.5 / 13	53	10	1569040000
VG 42-K68	PG 42	30-38	66.5 / 13	60	10	1569050000
VG 48-K68	PG 48	34-44	67.5 / 14	65	10	1718770000

Note Long-thread version on request, halogen-free without sealing ring.
Installation specifications and tightening torques can be found in the installation instructions.
For further information please use our online catalogue: catalog.weidmueller.com.

J

Cable glands – Plastic – SKS



Cable gland made of plastic with spiral bending protection and integrated strain relief, specially suited for moving connections. It prevents cables from bending at acute angles.

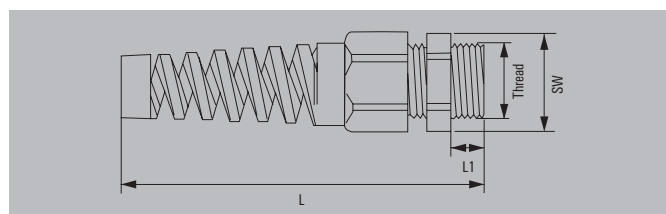

Technical data

Material / Colour	Polyamide 6 / Light Grey / RAL 7035
Seal insert	CR
Temperature range	-20 °C...100 °C
Protection class	IP68 - 5 bar (30 min.)
Flammability rating	V-2
Note	Version with moulded sealing lip Length L varies depending on the cable diameter used.

Ordering data

Type	Thread	KB	L/L1	SW	Qty.	Order No.
metric						
VG M12-K68 SKS	M 12	3-6.5	63.5 / 8	15	100	1776700000
VG M16-K68 SKS	M 16	5-10	94.5 / 15	22	50	1776710000
VG M20-K68 SKS 6-12	M 20	6-12	101.5 / 11	24	50	1778860000
VG M20-K68 SKS 10-14	M 20	10-14	116 / 15	27	25	1776720000
VG M25-K68 SKS	M 25	13-18	132.5 / 15	33	25	1776730000
PG						
VG 7-K68 SKS	PG 7	3-6.5	63 / 8	15	50	1720470000
VG 9-K68 SKS	PG 9	4-8	74 / 8	19	50	1720480000
VG 11-K68 SKS	PG 11	5-10	87 / 8	22	100	1720490000
VG 13.5-K68 SKS	PG 13.5	6-12	98 / 9	24	50	1720500000
VG 16-K68 SKS	PG 16	10-14	112 / 10	27	25	1720510000
VG 21-K68 SKS	PG 21	13-18	130 / 11	33	20	1720520000

Note Long-thread version on request, halogen-free without sealing ring.
Installation specifications and tightening torques can be found in the installation instructions.
For further information please use our online catalogue: catalog.weidmueller.com.

Standard cable glands – Brass

Cable glands – Brass – IP68



Cable gland made of brass for industrial applications where IP68 or IP69K protection is required.

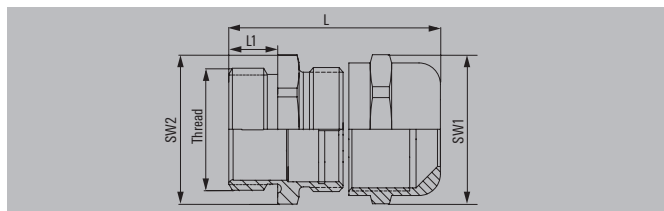

Technical data

Material	Brass, nickel-plated
O-ring / Seal insert	NBR / CR
Temperature range	-40 °C...100 °C
Clamp insert	Polyamide
Protection degree with GWDR	IP54, IP66, IP67, IP68 - 5 bar (30 min.), IP69K
Note	Length "L" varies depending on the cable diameter used; IP69K protection applies to all metric cable glands; the following thread sizes are excluded from IP69K: PG29, PG36, PG42 and PG48.

Ordering data

Type	Thread	KB	L/L1	SW1/SW2	Qty.	Order No.
metric						
VG M12 - MS 68	M 12	3-6.5	28 / 6	14 / 14	50	1772200000
VG M16 - MS 68	M 16	4-8	30 / 7	17 / 18	50	1772210000
VG M16-1/MS68	M 16	5-10	35.5 / 7	20 / 20	50	1909910000
VG M20 - MS 68	M 20	6-12	34.5 / 8	22 / 22	50	1772220000
VG M25 - MS 68	M 25	10-14	35.7 / 8	24 / 27	25	1772230000
VG M25-1/MS68	M 25	11-17	40.5 / 8	27 / 27	25	1909920000
VG M32 - MS 68	M 32	13-18	42 / 9	30 / 34	10	1772240000
VG M32-1/MS68	M 32	15-21	44 / 8	34 / 34	10	1909930000
VG M40 - MS 68	M 40	18-25	47 / 9	40 / 43	10	1772250000
VG M40-1/MS68	M 40	19-28	52.5 / 9	43 / 43	10	1909940000
VG M50 - MS 68	M 50	22-32	57 / 9	50 / 55	5	1772260000
VG M50-1/MS68	M 50	27-38	61 / 9	58 / 58	5	1909950000
VG M63 - MS 68	M 63	34-44	67 / 14	64 / 68	5	1772270000
PG (IP69K)						
VG 7-MS68	PG 7	3-6.5	28 / 6	14 / 14	50	1569060000
VG 9-MS68	PG 9	4-8	29.5 / 6	17 / 17	50	1569070000
VG 11-MS68	PG 11	5-10	32 / 6	20 / 20	50	1569080000
VG 13.5-MS68	PG 13.5	6-12	31 / 6.5	22 / 22	50	1569090000
VG 16-MS68	PG 16	10-14	34.5 / 6.5	24 / 24	25	1569100000
VG 21-MS68	PG 21	13-18	39.7 / 7.2	30 / 30	25	1569110000
PG (IP68)						
VG 29-MS68	PG 29	18-25	46.5 / 8	40 / 40	10	1569120000
VG 36-MS68	PG 36	22-32	57 / 9	50 / 50	5	1569130000
VG 42-MS68	PG 42	30-38	60.5 / 12	58 / 58	5	1569140000
VG 48-MS68	PG 48	34-44	69 / 14	64 / 64	5	1718790000

Note Long-thread version on request
 VDE for metric version
 Installation specifications and tightening torques can be found in the installation instructions.
 For further information please use our online catalogue: catalog.weidmueller.com.

Cable glands - Brass - IP68



Cable gland made of brass with spherical sealing insert which squeezes the cable gently over a large area. This cable gland is suitable for railway applications; its sealing material conforms to the requirements of EN 45545.

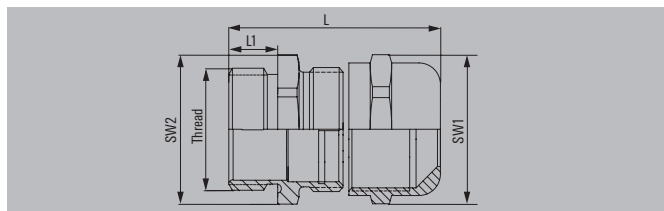

Technical data

Material	Brass, nickel-plated
O-Ring / Seal insert	NBR / T80s
Temperature range	-40 °C ... 130 °C
Protection class	IP68 - 15 bar
Note	

Ordering data

Type	Thread	KB	L/L1	SW	Qty.	Order No.
VGM25-MS68 11-20 BG	M 25	11-20	36.5 / 7.5	30	50	1193600000
VGM32-MS68 15-25 BG	M 32	15-25	40 / 8	36	25	1193610000
VGM40-MS68 20-32 BG	M 40	20-32	43 / 8	45	10	1193620000
VGM40/1-MS68 20-32 BG	M 40	20-32	82 / 8	45	10	1205890000
Note	When using mounting covers with 3 X M 40 cable input threads, the elongated version must be used for the cable gland in the middle. Installation specifications and tightening torques can be found in the installation instructions. For further information please use our online catalogue: catalog.weidmueller.com					

Standard cable glands – Brass

Clamping screws – Brass – IP65



The special cable glands (clamping screws) are designed for use in HDC RockStar® base enclosures. The seal insert used contains several removable or separable inlets.

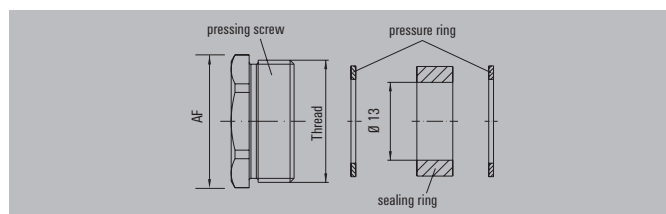

Technical data

Clamping screw material	Brass, nickel-plated
Sealing ring material	SBR/NBR
Pressure ring material	Polyamide
Temperature range	-20 °C...60 °C
Protection class	IP65
Note	

Ordering data

Type	Thread	Inserts in mm	SW	Qty.	Order No.
metric					
VG H M20 MS	M 20	4 / 7 / 10 / 13	20	50	1921720000
VG H M25 MS	M 25	8.5 / 11.5 / 14.5 / 18	25	25	1921740000
VG H M32 MS	M 32	16 / 19 / 22 / 25	32	20	1921760000
VG H M40 MS	M 40	23 / 26 / 29 / 32	40	10	1921770000
PG					
KV 11-M	PG 11	7.5 / 10 / 12.5	18	10	1656390000
KV 13-M	PG 13	7.5 / 10 / 12.5	20	10	1656400000
KV 16-M	PG 16	7.5 / 10 / 12.5 / 15	22	10	1656410000
KV 21-M	PG 21	10 / 13 / 16 / 19	28	10	1656420000
KV 29-M	PG 29	18 / 21 / 24 / 27	37	10	1656430000
Note					



Cable glands – Brass – EMC-4



Cable gland made of brass with EMC contact system for the particularly time-saving installation of shielded cables. It is characterised by the following features: very low installation effort, vibration-resistant and patented active contact system.

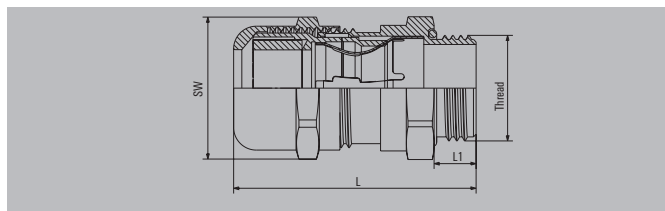

Technical data

Material	Brass, nickel-plated
O-Ring / Seal insert	NBR / CR
Temperature range	-40 °C...100 °C
Protection class	IP66, IP68 - 5 bar (30 min.), IP69K
Clamp insert	Polyamide
Note	

Ordering data

Type	Thread	KB	Shield Ø	L/L1	SW	Qty.	Order No.
VG M12 EMV-4 MS 3-6.5	M 12	3-6.5	2.00-5.00	34 / 6	14	50	2435070000
VG M16 EMV-4 MS 5-10	M 16	5-10	3.50-8.00	39 / 6	20	50	2435140000
VG M20 EMV-4 MS 6-12	M 20	6-12	4.50-10.00	38 / 6	22	50	2435150000
VG M20 EMV-4 MS 8-14	M 20	7.5-14	5.50-11.50	48 / 8	24	50	2435160000
VG M25 EMV-4 MS 10-18	M 25	10-18	7.00-14.00	51 / 8	30	25	2435170000
VG M32 EMV-4 MS 16-25	M 32	16-25	12.00-20.00	62 / 9	40	10	2435180000
VG M40 EMV-4 MS 22-32	M 40	22-32	18.00-27.00	69.5 / 9	50	5	2435190000
VG M50 EMV-4 MS 30-38	M 50	30-38	26.00-34.00	62 / 9	58	5	2435200000
VG M63 EMV-4 MS 34-44	M 63	34-44	30.00-40.00	73 / 14	68	5	2435210000

Note Installation specifications and tightening torques can be found in the installation instructions.
For further information please use our online catalogue: catalog.weidmueller.com.

EMC cable glands

Cable glands – Brass – EMC SET



Cable gland made of brass for internal shield connection or potential equalisation; easy-to-use, permanent, secure shield connection. This cable gland is suitable for railway applications; its sealing material meets the requirements of EN 45545.

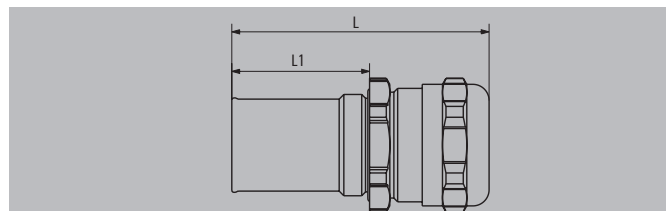

Technical data

Material	Brass, nickel-plated
O-Ring / Seal insert	NBR / T80s
Temperature range	-40 °C ... 130 °C
Protection class	IP68 - 15 bar

Note

Ordering data

Type	Thread	KB	L/L1	SW	Qty.	Order No.
VGM25-MS68 EMC 11-20SET	M 25	11-20	63.5 / 34	30	1	1463720000
VGM32-MS68 EMC 15-25SET	M 32	15-25	66.5 / 34	36	1	1463730000

Note Installation specifications and tightening torques can be found in the installation instructions. For further information please use our online catalogue: catalog.weidmueller.com.

Cable glands – Stainless steel – IP68



Cable gland made of stainless steel for standard industrial applications that require a high degree of protection (IP68 or IP69K). These cable glands – with their resistance to impact and sea water – are also suitable for use in applications under extreme environmental conditions.

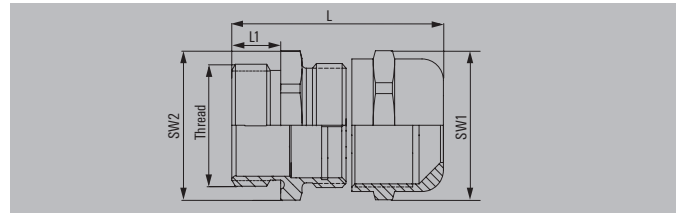

Technical data

Material	Stainless steel 1.4305 (303)
O-Ring / Seal insert	NBR / CR
Temperature range	-40 °C...100 °C
Protection class	IP54, IP66, IP67, IP68 - 5 bar (30 min.), IP69K
Note	

Ordering data

Type	Thread	KB	L/L1	SW1/SW2	Qty.	Order No.
metric						
VGM12-SS 68 KB 3-6.5	M 12	3-6.5	28 / 6	14 / 14	50	1009840000
VGM16-SS 68 KB 4-8	M 16	4-8	30 / 7	17 / 19	50	1009850000
VGM20-SS 68 KB 6-12	M 20	6-12	32 / 8	22 / 22	50	1009860000
VGM25-SS 68 KB 10-14	M 25	10-14	35.5 / 8	24 / 27	25	1009870000
VGM32-SS 68 KB 13-18	M 32	13-18	41.5 / 9	30 / 36	20	1009880000
VGM40-SS 68 KB 18-25	M 40	18-25	49.6 / 9	41 / 46	20	1009890000
VGM50-SS 68 KB 22-32	M 50	22-32	55 / 9	50 / 55	5	1009900000
VGM63-SS 68 KB 34-44	M 63	34-44	67 / 14	65 / 70	5	1009910000
PG						
VG 7-SS 68 KB 3-6.5	PG 7	3-6.5	28 / 6	14 / 14	50	1009740000
VG 9-SS 68 KB 4-8	PG 9	4-8	29 / 6	17 / 17	50	1009750000
VG 11-SS 68 KB 5-10	PG 11	5-10	31.5 / 6	22 / 22	50	1009760000
VG 16-SS 68 KB 10-14	PG 16	10-14	34 / 6.5	24 / 24	25	1009780000
VG 21-SS 68 KB 13-18	PG 21	13-18	39.7 / 7.2	30 / 30	25	1009790000
VG 29-SS 68 KB 18-25	PG 29	18-25	46.5 / 8	41 / 41	20	1009800000
VG 36-SS 68 KB 22-32	PG 36	22-32	55 / 9	50 / 50	15	1009810000
Note	1.4404 (316L) on request. Installation specifications and tightening torques can be found in the installation instructions. For further information please use our online catalogue: catalog.weidmueller.com .					

Standard cable glands – Stainless steel

Cable gland – Stainless steel – IP68



Cable gland with spherical seal insert that squeezes the cable gently over a large area. This cable gland is suitable for railway applications; its sealing material meets the requirements of EN 45545.

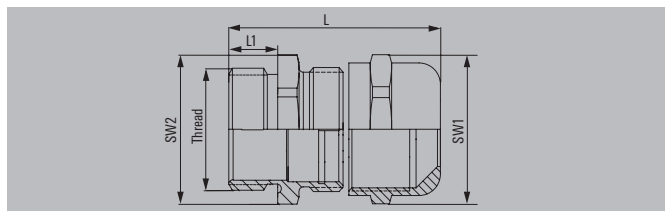

Technical data

Material	Stainless steel 1.4305 (303)
O-Ring / Seal insert	Silicone / T80s
Temperature range	-40 °C ... 130 °C
Protection class	IP68 - 15 bar

Note

Ordering data

Type	Thread	KB	L/L1	SW	Qty.	Order No.
VGM25-SS68 11-20 BG	M 25	11-20	36.5 / 7.5	30	50	1193570000
VGM32-SS68 15-25 BG	M 32	15-25	40 / 8	36	25	1193580000
VGM40-SS68 20-32 BG	M 40	20-32	43 / 8	45	10	1193590000
VGM40/1-SS68 20-32 BG	M 40	20-32	82 / 8	45	10	1205920000

Note

When using mounting covers with 3 X M 40 cable input threads, the elongated version must be used for the cable gland in the middle.
 Installation specifications and tightening torques can be found in the installation instructions.
 For further information please use our online catalogue: catalog.weidmueller.com

IP65 cable gland with multi-wire sealing



Gland with multiple sealing insert. The laterally slotted sealing inserts allow the use of already assembled cables. Versions with different hole diameters as well as different number of holes available. Unused holes can be easily closed and sealed with a sealing bolt (VB).

Technical data

Material	Messing, vernickelt
Seal insert	TPE
Temperature range	-40 °C ... 135 °C
Protection class	IP65
Note	

Ordering data

Gland	Hole diameter	Thread	SW	Qty.	Order No.
VGM32-MS65 3X6.7 SL	3 x 6.7 mm	M32	36	25	2784970000
VGM32-MS65 3X7.6 SL	3 x 7.6 mm	M32	36	25	2784960000
VGM32-MS65 4X7 SL	4 x 7 mm	M32	36	25	2784940000
VGM32-MS65 4X8 SL	4 x 8 mm	M32	36	25	2784950000
Closure bolt	Diameter			Qty.	Order No.
VB 7.0X25 BK	7 mm			100	2784930000
VB 8.0X20 BK	8 mm			100	2784920000

Note					
-------------	--	--	--	--	--

Standard cable glands

HQ cable glands



Cable gland especially for heavy-duty connectors of the HQ series, available in plastic, brass and as brass EMC version.

Technical data

Material	Polycarbonate
Seal insert	TPE
Temperature range	-20 °C ... 100 °C
Protection class	IP68
Note	

Ordering data

Type	Thread	KB	SW	Qty.	Order No.
Plastic					
VG 16 HQ K68 4-6.5	PG 16	4-6.5	27	1	2715990000
VG 16 HQ K68 6.5-9.5	PG 16	6.5-9.5	27	1	1273890000
VG 16 HQ K68 9-13	PG 16	9-13	27	1	1016070000
VG 16 HQ K68 11.5-15.5	PG 16	11.5-15.5	27	1	1016080000
brass					
VG 21 HQ MS68 9-13	PG 21	9-13	30	1	1016090000
VG 21 HQ MS68 11.5-15.5	PG 21	11.5-15.5	30	1	1016100000
VG 21 HQ MS68 14-18	PG 21	14-18	30	1	1016110000
EMC					
VG 21 HQ EMV68 11-15.5	PG 21	11-15.5	30	1	1016120000
VG 21 HQ EMV68 14-18	PG 21	14-18	30	1	1016130000
only for angled HQ base enclosure (order number 1003110000)					
VG16 HQ K68 9-12SH	PG 16	9-12	30	50	1045530000
VG16 HQ K68 11.5-15.5SH	PG 16	11.5-15.5	30	1	1045540000
Note					
Installation specifications and tightening torques can be found in the installation instructions. For further information please use our online catalogue: catalog.weidmueller.com .					

Lock nuts – Plastic 7035



For fastening cable glands and accessories if no threaded hole is available. With circumferential collar to prevent damage to the substrate during installation.

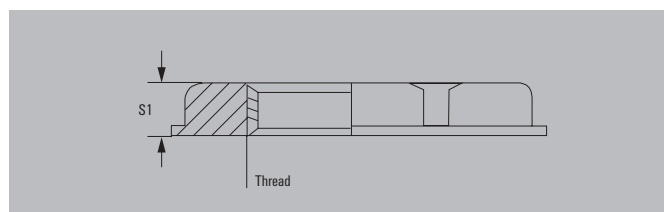

Technical data

Material / Colour	Polyamid 6 (PA6 - GF30) / Light Grey / RAL 7035
Temperature range	-40 °C...100 °C
Flammability rating	HB
Note	

Ordering data

Type	Thread	S1	SW	Qty.	Order No.
metric					
SKMU M12 - K GR	M 12	5.00	18	100	1772440000
SKMU M16 - K GR	M 16	5.00	22	100	1772450000
SKMU M20 - K GR	M 20	6.00	26	100	1772460000
SKMU M25 - K GR	M 25	6.00	32	100	1772470000
SKMU M32 - K GR	M 32	7.00	41	100	1772480000
SKMU M40 - K GR	M 40	7.00	50	50	1772490000
SKMU M50 - K GR	M 50	8.00	60	10	1772500000
SKMU M63 - K GR	M 63	8.00	75	10	1772510000
PG					
SKMU PG7-K GR	PG 7	5.00	19	100	1697440000
SKMU PG9-K GR	PG 9	5.00	22	100	1697450000
SKMU PG11-K GR	PG 11	5.00	24	100	1697460000
SKMU PG 13,5-K GR	PG 13.5	6.00	27	100	1697470000
SKMU PG16-K GR	PG 16	6.00	30	100	1697480000
SKMU PG21-K GR	PG 21	7.00	36	100	1698220000
SKMU PG29-K GR	PG 29	7.00	46	50	1698230000
SKMU PG36-K GR	PG 36	8.00	60	25	1698240000
SKMU PG42-K GR	PG 42	8.00	65	25	1698250000
SKMU PG48-K GR	PG 48	8.00	70	25	1719090000

Note Further versions on request.

Accessories – Lock nuts

Lock nuts – Plastic 9005



Lock nuts with collar for preventing enclosure damage on installation. These are used to secure plastic cable glands and blanking plugs - recommended for Ex e and Ex i plastic cable glands.

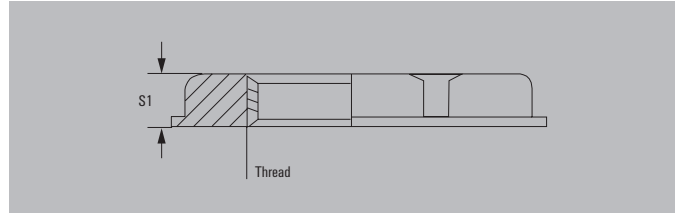

Technical data

Material / Colour	Polyamid 6 (PA6 - GF30) / Deep black / RAL 9005
Temperature range	-40 °C...100 °C
Flammability rating	HB
Note	Accessories for Ex cable glands are not subject to approval.

Ordering data

Type	Thread	S1	SW	Qty.	Order No.
metric					
SKMU M12 K SW	M 12	5.00	18	100	1806540000
SKMU M16 K SW	M 16	5.00	22	100	1736920000
SKMU M20 K SW	M 20	6.00	26	100	1736930000
SKMU M25 K SW	M 25	6.00	32	25	1736940000
SKMU M32 K SW	M 32	7.00	41	100	1736950000
SKMU M40 K SW	M 40	7.00	50	10	1736960000
SKMU M50 K SW	M 50	8.00	60	5	1736970000
SKMU M63 K SW	M 63	8.00	75	5	1736980000
PG					
SKMU PG7-K SW	PG 7	5.00	19	100	1719100000
SKMU PG9-K SW	PG 9	5.00	22	50	1719110000
SKMU PG11-K SW	PG 11	5.00	24	50	1719120000
SKMU PG13,5-K SW	PG 13.5	6.00	27	50	1719130000
SKMU PG16-K SW	PG 16	6.00	30	100	1719140000
SKMU PG21-K SW	PG 21	7.00	36	100	1719150000
SKMU PG29-K SW	PG 29	7.00	46	20	1719160000
SKMU PG36-K SW	PG 36	8.00	60	10	1719170000
SKMU PG42-K SW	PG 42	8.00	65	25	1719180000
SKMU PG48-K SW	PG 48	8.00	70	25	1719190000
Note	Further versions on request.				

J

Lock nuts – Brass – nickel-plated



For fastening cable glands and accessories if no threaded hole is available. Recommended when working with Ex applications.

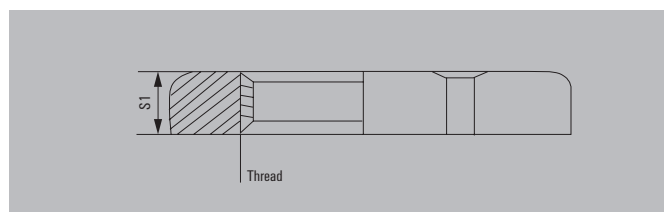

Technical data

Material	Brass, nickel-plated
Note	

Ordering data

Type	Thread	S1	SW	Qty.	Order No.
metric					
SKMU M12 MS	M 12	2.8	15	100	1772360000
SKMU M16 MS	M 16	2.8	19	100	1736990000
SKMU M20 MS	M 20	3	24	100	1737000000
SKMU M25 MS	M 25	3.5	30	100	1737010000
SKMU M32 MS	M 32	4	36	100	1737020000
SKMU M40 MS	M 40	5	46	50	1737030000
SKMU M50 MS	M 50	5	57	25	1737040000
SKMU M63 MS	M 63	6	70	25	1737050000
SKMU M75 MS	M 75	7	80	5	1737060000
PG					
SKMU PG7-MS	PG 7	2.8	15	100	1694070000
SKMU PG9-MS	PG 9	2.8	18	100	1694080000
SKMU PG11-MS	PG 11	3	21	100	1694090000
SKMU PG13,5-MS	PG 13.5	3	23	100	1694100000
SKMU PG16-MS	PG 16	3	26	100	1694110000
SKMU PG21-MS	PG 21	3.5	32	100	1719200000
SKMU PG29-MS	PG 29	4	41	50	1719210000
SKMU PG36-MS	PG 36	5	51	50	1719220000
SKMU PG42-MS	PG 42	5	60	25	1719230000
SKMU PG48-MS	PG 48	5.5	64	10	1719240000

Note Further versions on request.

Accessories - Lock nuts

Lock nuts - Brass - natural



For fastening cable glands and accessories if no threaded hole is available. Recommended when working with Ex applications.

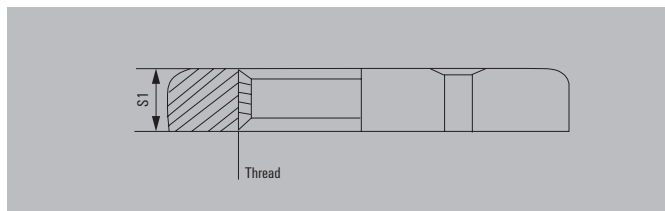

Technical data

Material	Brass
Note	

Ordering data

Type	Thread	S1	SW	Qty.	Order No.
metric					
SKMU M16 MS SC	M 16	4	22	50	0930640001
SKMU M20 MS SC	M 20	4	24	50	0930640002
SKMU M25 MS SC	M 25	4	30	25	0930640003
SKMU M32 MS SC	M 32	4	40	20	0930640004
SKMU M40 MS SC	M 40	4.8	46	10	0930640005
SKMU M50 MS SC	M 50	5	65	5	0930640006
SKMU M63 MS SC	M 63	6.4	80	5	0930640007
SKMU M75 MS SC	M 75	7	90	5	0930640008
Note					

Lock nuts – Brass – EMC



For fastening cable glands and accessories if no threaded hole is available. Specially equipped with 6 edges which contact the enclosure when the lock nut is tightened.

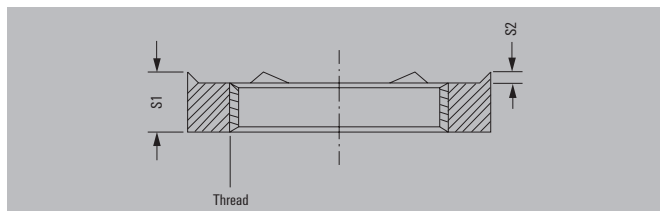

Technical data

Material	Brass, nickel-plated
Note	

Ordering data

Type	Thread	S1	SW	Qty.	Order No.
metric					
SKMU EMV M12	M 12	3.6	15	100	1777610000
SKMU EMV M16	M 16	3.6	19	100	1777620000
SKMU EMV M20	M 20	3.6	24	100	1777630000
SKMU EMV M25	M 25	3.6	30	50	1777640000
SKMU EMV M32	M 32	4.1	36	50	1777650000
SKMU EMV M40	M 40	4.6	46	10	1777660000
SKMU EMV M50	M 50	4.6	60	10	1777670000
SKMU EMV M63	M 63	6.6	70	10	1777680000
PG					
SKMU EMV PG7	PG 7	4.7	15	20	1718900000
SKMU EMV PG9	PG 9	4.7	18	20	1718910000
SKMU EMV PG11	PG 11	4.7	21	20	1718920000
SKMU EMV PG13,5	PG 13,5	4.7	23	10	1718930000
SKMU EMV PG16	PG 16	4.7	26	10	1718940000
SKMU EMV PG21	PG 21	5.2	32	10	1718950000
SKMU EMV PG29	PG 29	5.7	41	15	1718960000
SKMU EMV PG 36	PG 36	4.6	51	1	1777710000
SKMU EMV PG 48	PG 48	5.6	64	1	1777690000

Note	Further versions on request.
------	------------------------------



Accessories - Lock nuts

Lock nuts - Stainless steel



For fastening cable glands and accessories if no threaded hole is available. Recommended for Ex applications.

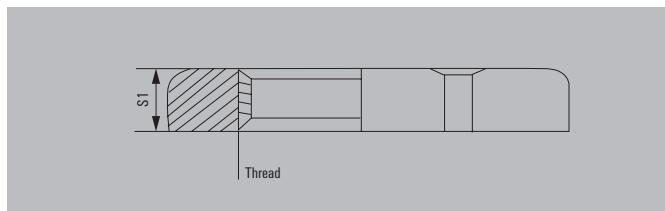

Technical data

Material	Stainless steel 1.4404
Note	

Ordering data

Type	Thread	S1	SW	Qty.	Order No.
metric					
SKMUS M16-W	M 16	2.80	20	240	1185680000
SKMUS M20-W	M 20	3.00	24	240	1185690000
SKMUS M25-W	M 25	3.00	30	240	1185700000
SKMUS M32-W	M 32	4.00	38	144	1185710000
SKMUS M40-W	M 40	4.50	46	144	1185720000
SKMUS M50-W	M 50	5.00	60	30	1185730000
SKMUS M63-W	M 63	6.00	75	20	1185740000
Note					



Flat IP washer – Standard – Polyethylene



For better sealing of the connection thread of a cable gland or accessory.

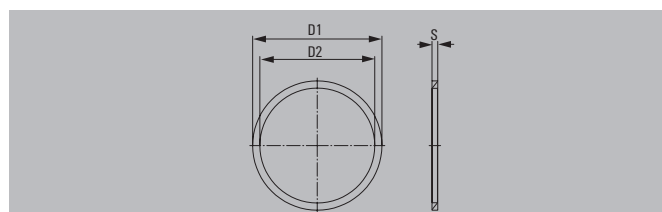

Technical data

Material / Colour	Polyethylene / Transparent
Temperature range	-30 °C...90 °C
Note	

Ordering data

Type	Thread	D1	D2	S	Qty.	Order No.
metric						
GWDR M12-PO	M 12	16.00	12.00	2	50	1777920000
GWDR M16-PO	M 16	20.00	16.00	2	50	1777930000
GWDR M20-PO	M 20	24.00	20.00	2	100	1777940000
GWDR M25-PO	M 25	29.00	25.00	2	50	1777950000
GWDR M32-PO	M 32	36.00	32.00	2	50	1777960000
GWDR M40-PO	M 40	45.00	40.00	2	50	1777970000
GWDR M50-PO	M 50	56.00	50.00	2	50	1777980000
GWDR M63-PO	M 63	70.00	63.00	2	50	1777990000
PG						
GWDR PG7-PO	PG 7	16.50	12.50	2	100	1719440000
GWDR PG9-PO	PG 9	19.00	15.20	2	100	1719450000
GWDR PG11-PO	PG 11	22.50	18.60	2	100	1719460000
GWDR PG13,5-PO	PG 13.5	25.00	20.40	2	100	1719470000
GWDR PG16-PO	PG 16	27.00	22.50	2	100	1719480000
GWDR PG21-PO	PG 21	33.50	28.30	3	100	1719490000
GWDR PG29-PO	PG 29	43.50	37.00	3	50	1719500000
GWDR PG36-PO	PG 36	55.00	47.00	3	50	1719510000
GWDR PG42-PO	PG 42	63.00	54.00	3	10	1719520000
GWDR PG48-PO	PG 48	69.00	59.30	3	5	1719530000

Note	Further versions on request.
-------------	------------------------------



Accessories - Flat IP washer

Flat IP washer - Standard - Neoprene



For better sealing of the connection thread of a cable gland or accessory.

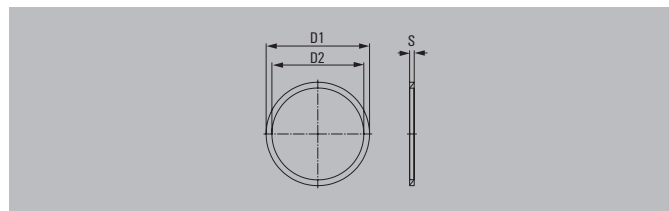

Technical data

Material / Colour	Neoprene / Deep black
Temperature range	-40 °C...100 °C
Note	

Ordering data

Type	Thread	D1	D2	S	Qty.	Order No.
metric						
GWDR M12-NP	M 12	18.00	12.00	1.20	50	1913320000
GWDR M16-NP	M 16	22.00	16.00	1.20	50	1736230000
GWDR M20-NP	M 20	24.00	20.00	1.20	50	1736240000
GWDR M25-NP	M 25	30.00	25.00	1.50	100	1736250000
GWDR M32-NP	M 32	42.00	32.00	1.50	50	1736260000
GWDR M40-NP	M 40	52.00	40.00	1.50	20	1736270000
GWDR M50-NP	M 50	63.00	50.00	1.50	20	1736280000
GWDR M63-NP	M 63	77.00	63.00	2.00	10	1736290000
PG						
GWDR PG7-NP	PG 7	17.00	11.60	1.20	100	1719540000
GWDR PG9-NP	PG 9	21.00	14.00	1.20	100	1719550000
GWDR PG11-NP	PG 11	24.00	17.00	1.20	100	1719560000
GWDR PG13,5-NP	PG 13.5	27.00	19.50	1.20	100	1719570000
GWDR PG16-NP	PG 16	30.00	22.50	1.20	100	1719580000
GWDR PG21-NP	PG 21	35.00	28.30	1.50	100	1719590000
GWDR PG29-NP	PG 29	45.00	37.00	1.50	50	1719600000
GWDR PG36-NP	PG 36	60.00	47.00	1.50	20	1719610000
GWDR PG42-NP	PG 42	65.00	54.00	1.50	10	1719620000
GWDR PG48-NP	PG 48	71.00	59.30	1.50	5	1719630000

Note	Further versions on request.
-------------	------------------------------

J

Flat IP washer – Standard – Nylon



For better sealing of the connection thread of a cable gland or accessory.

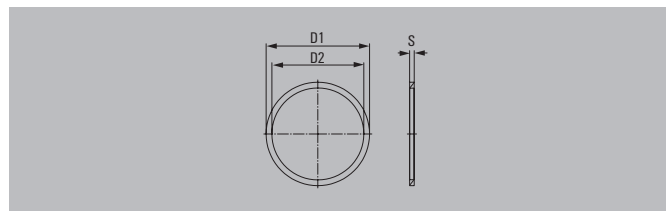

Technical data

Material / Colour	Nylon 6 / white / RAL 9010
Temperature range	-50 °C...120 °C
Note	

Ordering data

Type	Thread	D1	D2	S	Qty.	Order No.
metric						
GWDR M16-W	M 16	26	16.30	2.00	100	1185600000
GWDR M20-W	M 20	30	20.30	2.00	100	1185610000
GWDR M25-W	M 25	38	25.30	2.00	100	1185620000
GWDR M32-W	M 32	46	32.30	2.00	160	1185630000
GWDR M40-W	M 40	55	40.30	2.00	50	1185640000
GWDR M50-W	M 50	65	50.30	2.00	25	1185650000
GWDR M63-W	M 63	80	63.30	2.00	10	1185670000
Note						



Blanking plugs

Blanking plugs – Plastic



Plastic blanking plug with cross-head is used to seal surplus threaded holes and to maintain the IP protection degree.

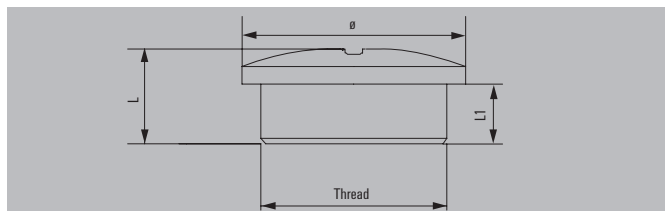

Technical data

Material / Colour	Polyamid 6 (PA6 - GF30) / Light Grey / RAL 7035
Temperature range	-40 °C...100 °C
Protection class	IP54
Flammability rating	V-2
Note	Optional sealing ring.

Ordering data

Type	Thread	L	L1	Head Ø	Qty.	Order No.
metric						
VP M12 K54	M 12	5.5	6	15.00	100	1776930000
VP M16 K54	M 16	5.5	7	20.00	100	1776920000
VP M20 K54	M 20	6.5	7	24.00	100	1776910000
VP M25 K54	M 25	7	10	30.00	100	1776900000
VP M32 K54	M 32	7	11	37.00	50	1776940000
VP M40 K54	M 40	7	13	46.00	25	1776950000
VP M50 K54	M 50	8.5	14	56.00	10	1776960000
VP M63 K54	M 63	8.5	15	69.50	50	1776970000
PG						
VP 7-K54	PG 7	8	6	15.00	100	1719250000
VP 9-K54	PG 9	9.5	5	19.00	100	0294760000
VP 11-K54	PG 11	10	6.5	22.00	100	0294860000
VP 13,5-K54	PG 13.5	10	5	25.00	100	0294960000
VP 16-K54	PG 16	10	5	27.00	100	0295060000
VP 21-K54	PG 21	12	8	33.00	50	0295160000
VP 29-K54	PG 29	11.5	8	44.00	25	0501160000
VP 36-K54	PG 36	14	10	55.00	10	0501260000
VP 42-K54	PG 42	14	10	62.00	5	0501360000
VP 48-K54	PG 48	16	12	69.00	5	1719260000

Note Other versions available on request. The blanking plugs must be tightened "hand-tight" with the screwdriver.

J

Blanking plugs – Brass – Nickel-plated



Brass blanking plug with cross-head is used to seal surplus threaded holes and to maintain the IP protection degree.

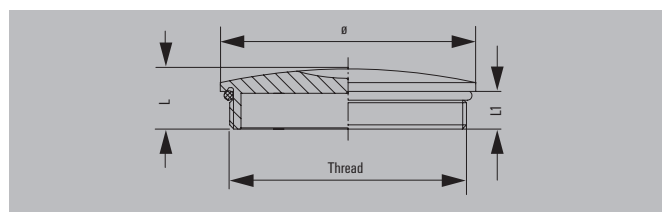

Technical data

Material	Brass, nickel-plated
O-Ring	NBR
Temperature range	-40 °C...100 °C
Protection class	IP68 - 5 bar (30 min.)

Note

Ordering data

Type metric	Thread	L	L1	Head Ø	Qty.	Order No.
VP M12-MS65	M 12	7.5	5	14.00	100	1777720000
VP M16-MS65	M 16	8	5	18.00	100	1777730000
VP M20-MS65	M 20	9.5	6	22.00	100	1777740000
VP M25-MS65	M 25	11	7	28.00	100	1777750000
VP M32-MS65	M 32	12	8	35.00	50	1777760000
VP M40-MS65	M 40	13	8	44.00	50	1777770000
VP M50-MS65	M 50	15	9	54.00	25	1777780000
VP M63-MS65	M 63	16	10	67.00	10	1777790000
PG						
VP 7-MS65	PG 7	7.5	5	15.00	100	0521600000
VP 9-MS65	PG 9	8	5	18.00	100	0294700000
VP 11-MS65	PG 11	8	5	22.00	100	0294800000
VP 13,5-MS65	PG 13,5	9	6	24.00	100	0294900000
VP 16-MS65	PG 16	9	6	26.00	100	0295000000
VP 21-MS65	PG 21	10	6	32.00	50	0295100000
VP 29-MS65	PG 29	12	8	40.00	50	0501100000
VP 36-MS65	PG 36	15	9	50.00	25	0501200000
VP 42-MS65	PG 42	16	10	57.00	25	0501300000
VP 48-MS65	PG 48	16	10	64.00	10	1719270000

Note Other versions available on request. The blanking plugs must be tightened "hand-tight" with the screwdriver.

Adapter

Adapter with metric male threads - Brass, nickel-plated



The ADAP series adapters offer flexibility and versatility in re-using existing entries in Ex equipment, while flameproof Ex d and increased safety Ex e explosion protection and IP66/67/68 protection.

Technical data

Material	Brass, nickel-plated
Operating temperature	-50 °C...120 °C
Protection class	IP66
Marking	II 2G 1D, Ex db IIC Gb, Ex eb IIC Gb, Ex ta IIIC Da

Ordering data

External thread	M20	M16	M25	M32	M40	M50
Inner thread	Order No.	Order No.	Order No.	Order No.	Order No.	Order No.
M16	1262740000					
M20		1262730000	1262760000			
M25	1262750000			1262780000		
M32			1262770000		1262800000	
M40				1262790000		1262830000
M50					1262810000	
1/2" NPT	1262860000	1262840000	1262880000			
3/4" NPT	1262870000	1262850000	1262890000	1262910000		
1" NPT			1262900000	1262930000	1262960000	
1 1/4" NPT				1262940000	1262970000	1263000000
1 1/2" NPT				1262950000	1262980000	1263010000
2" NPT					1262990000	1263030000

Note

Adapter with metric male threads - Stainless steel



The ADAP(S) series adapters offer flexibility and versatility in re-using existing entries in Ex equipment, while flameproof Ex d and increased safety Ex e explosion protection and IP66/67/68 protection.

Technical data

Material	Stainless steel 1.4404
Operating temperature	-50 °C...120 °C
Protection class	IP66
Marking	II 2G 1D, Ex db IIC Gb, Ex eb IIC Gb, Ex ta IIIC Da

Ordering data

External thread	M20	M16	M25	M32	M40	M50
Inner thread	Order No.	Order No.	Order No.	Order No.	Order No.	Order No.
M16	1261920000					
M20		1261910000	1261940000			
M25	1261930000			1261960000		
M32			1261950000		1261980000	
M40				1261970000		1262010000
M50						1261990000
1/2" NPT	1262040000	1262020000	1262060000			
3/4" NPT	1262050000	1262030000	1262070000	1262090000		
1" NPT			1262080000	1262100000	1262130000	
1 1/4" NPT				1262110000	1262140000	1262180000
1 1/2" NPT				1262120000	1262150000	1262190000
2" NPT					1262170000	1262200000

Note

--	--	--	--	--	--	--

Service and support

Service and support	Service connects - worldwide	V.2
	Engineering services and customised products	V.3
	easyConnect - Your Industrial Service Platform	V.4
	Support Center	V.6
	Additional support services	V.7
	Weidmüller Configurator: intuitive, uncomplicated & fast digital engineering	V.8

Our expertise for your requirements

Service connects – worldwide



Automation technology functions are becoming more complex in a globally-oriented world facing ambitious targets in terms of energy efficiency and smart production. We are your equal partners for the best connections in Industrial Connectivity.

Our personal support answers all questions reliably and expertly. During planning, installation or operation our service and support offer is your best companion.

In short: Weidmüller's global service combines our expertise with your requirements.

V



Your way to our service
www.weidmueller.com/service

Engineering services and customised products

Automation engineering and connectivity consulting belongs to our services as well as assembly of engineered products. We also support the process from the idea to the product with our Weidmüller Configurator and the Configure-to-Order process.



Consulting and engineering

The challenge for you is reducing costs and increasing efficiency. This requires intelligent, individual solutions. Whether it is modified products, pre-fitted mounting rails or complete small cabinets – our application centres provide a highly qualified custom-made engineering and production service.



Connectivity Consulting

Increase your competitiveness - supported by our experts. Our drive is to optimise your competitiveness. That's why our team of experts supports you in significantly increasing your efficiency in electrical machine design and control cabinet construction. With proven products and services from the Weidmüller portfolio – and with the experience gained from over 300 projects worldwide.



Assembled terminal rails - Flexibly designed to suit your requirements

Your processes in panel building have to be fast, flexible and productive. This is the only way you can cut your costs and increase efficiency. Depending on the application in question, you will have different requirements with respect to the engineering service, delivery speed and flexibility to be provided.



Modified and assembled enclosures - Competitive advantages included

To compete internationally, your plants need to satisfy high standards of safety, quality and performance. The smart combination of consultation, application expertise and industry know-how is our key to finding a custom-fit solution for your application. Reduce costs and increase efficiency.

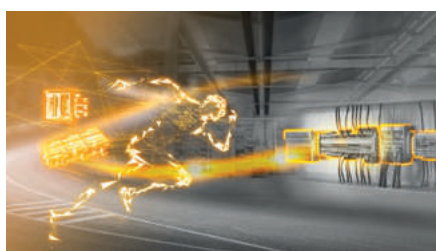

Fast Delivery Service - Your ideas deserve a quick realisation

Obtain offers 24/7 and within minutes, including directly orderable article numbers with our Fast Delivery Service. The Weidmüller Configurator (WMC) for planning and configuration is key for consistent processes. Dispatch your orders in 5 days. Assemble individual terminal strips and enclosures from batch size 1!

Your ticket to the world of digital service

easyConnect – Your Industrial Service Platform



Our cloud-based platform is your ticket to the world of digital services from Weidmüller, and the intuitive and future-proof tool for your way to the Industrial IoT. Realise your use cases easily, consistently and without any relevant prior knowledge, thanks to the perfect interaction of platform, devices and diverse software services.

As an open, modular and perfectly integrable system, the platform is your enabler for a wide range of use cases. Increase your efficiency and unleash your full innovation potential with easyConnect.

V



Interested in using easyConnect?

Learn how to get started with easyConnect step-by-step.

www.weidmueller.com/easyconnect

Why should you use easyConnect?

- You want to enter your digital transformation step-by-step?
- You want to make the step into Industrial IOT, but have no or little IT expertise?
- You want to use your digital data for smart & scalable services?
- You want to offer digital services (such as customised dashboard) to your customers?
- You want to improve your service offering and efficiency, e.g. through remote access?
- You feel Weidmüller's digital services are interesting, but you have „your cloud“ already?



Weidmüller comes up with the solution: easyConnect, the new digitalisation platform. It bundles Weidmüller's digital services at one place in the cloud and connects them with various Weidmüller devices.

With easyConnect you start digitalising your application step-by-step without ballast in a secure way.

The following services are initially available on easyConnect:



Device management

Adding and managing cloud-connected devices is typically the first step in any Industrial IoT use case.

Asset management

The asset management service is a modelling tool that allows users to model their assets and processes and link them to relevant time series data.

Remote access (u-link)

u-link guarantees a quick and secure access to machines and plants while also allowing for efficient management.

Data visualisation

easyConnect data visualisation services enable users to view, monitor and display live and historical data.

AutoML

With Weidmüller Industrial AutoML, you can optimize operations, increase product quality and develop new business models by benefiting from advanced analytics.

Expand the possibilities of our products

Our Support Center provides you with comprehensive, clear and personal assistance



Receive fast and intuitive support to get the most out of our products in your application. In our new Support Center you can search or navigate to the many application notes, product information, video tutorials or software downloads of our products.

- **Everything at a glance** – One central support hub, where all relevant information is available
- **Powerful search** – Provides filter functions for various types of information and products
- **Different views and navigations** – Content provided in views product information, engineering support or software downloads
- **More than 170,000 downloads** – Application notes, video tutorials, templates and examples, user documentation, engineering data, ...
- **Personal contact** – Direct access to your personal technical contact in your country



Explore the world of our new Support Center
support.weidmueller.com

Additional support services



Training and Webinars

Stay tuned in a world that is accelerating. In our entertaining interactive webinars, we offer you the opportunity to learn about new products and technology topics and to interact with our experts.



Repairs and replacement parts

We offer repair and components for our Workplace Solutions as well as assistance for other Weidmüller products. Find out how our experts can help you with your repair request.



Security advisory board

Our Product Security Incident Response Team (PSIRT) continuously informs you about possible security-related vulnerabilities of our products.



Engineering data

For the quick integration of our products into your design, there are a lot of digital product data for engineering systems like EPLAN, Zuken E3.series, WSCAD and many others available for download.



Product change notifications

Technical modifications of our products always available online.



Technical product catalogues

Technical data for our entire program in Industrial Connectivity for download in PDF-format.

From the idea to the finished solution

Weidmüller Configurator: intuitive, uncomplicated & fast digital engineering

Digital engineering can be so easy – with the Weidmüller Configurator!

It's a **free to use** software application to easily configure industrial solutions. It features more than **12,000 articles** from multiple product families including rail-mounted components, industrial and ex-certified enclosures, Heavy Duty Connectors, remote I/O-systems and PCB connectors.

Unleash the full power of digital engineering:

Our application wizards help you choose the right articles.

Place, mark or modify them to your needs and get your solution **visualized in 3D** – what you see is what you get!

Our promise: Speed up your solution planning process by up to 70%!

Your benefits:

- **Proven configuration designs in real 3D:** The plausibility and collision check with the complete digital documentation ensures that you can rely 100% on your configuration.
- **Seamless E-CAD Roundtrip:** Interfaces enable the simple exchange of product data between the WMC and all common engineering tools, such as Zuken E3 or EPLAN Electric P8.
- **Sample Service & Fast Delivery Service:** to support your design-in process, we offer a **3-day sample service** for many products. Inquire them directly online – for free!
You want your solution right away? Our **Fast Delivery Service** guarantees delivery of individually assembled terminal strips or enclosures within a few days.

Get started online now!

The Weidmüller Configurator makes solution planning easy. Visit our website for more information, tutorials and download it for free:



www.weidmueller.com/wmc



or register on easyconnect.weidmueller.com and use it online.



Wizards:

Design complete applications within few clicks – even without detailed product knowledge – for signal wiring, load monitoring, instrument transformers, enclosures, remote I/O-systems and many more.

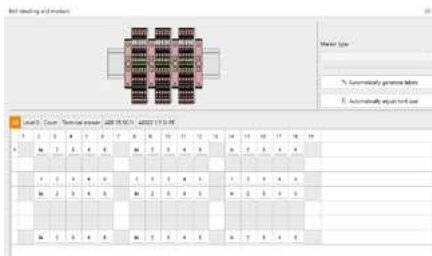

Assistants:

Finalize your solutions with supporting assistants to add cross-connectors, markers or colors and verify the faultlessness. Automatic modes save valuable time!



1-click documentation:

Get assembly drawings for production – only 1 click. Bill of material – only 1 click. The complete solution documentation including all component data sheets – you’re right, only 1 click!



Index

Index	Index Type	X.2
	Index Order No.	X.14
	Addresses worldwide	X.28

Table with 3 columns: Order No., Type, Page. Lists items 1201400000 through 1207500000.

Table with 3 columns: Order No., Type, Page. Lists items 1207500000 through 1219800000.

Table with 3 columns: Order No., Type, Page. Lists items 1219800000 through 1263030000.

1220000000

Table with 3 columns: Order No., Type, Page. Lists items 1220570000 through 1229120000.

1250000000

Table with 3 columns: Order No., Type, Page. Lists items 1251020000 through 1253270000.

1260000000

Table with 3 columns: Order No., Type, Page. Lists items 1261910000 through 1263030000.

Table with 3 columns: Order No., Type, Page. Lists items 1263030000 through 1269040000.

1270000000

Table with 3 columns: Order No., Type, Page. Lists items 1270320000 through 1273890000.

1280000000

Table with 3 columns: Order No., Type, Page. Lists items 1282820000 through 1289130000.

1290000000

Table with 3 columns: Order No., Type, Page. Lists item 1295600000.

1300000000

Table with 3 columns: Order No., Type, Page. Lists item 1301990000.

1320000000

Table with 3 columns: Order No., Type, Page. Lists items 1324500000 through 1324520000.

1330000000

Table with 3 columns: Order No., Type, Page. Lists item 1336600000.

1350000000

Table with 3 columns: Order No., Type, Page. Lists item 1354950000.

1360000000

Table with 3 columns: Order No., Type, Page. Lists item 1365030000.

1410000000

Table with 3 columns: Order No., Type, Page. Lists items 1415410000 through 1415420000.

1420000000

Table with 3 columns: Order No., Type, Page. Lists items 1428840000 through 1429370000.

1430000000

Table with 3 columns: Order No., Type, Page. Lists items 1435410000 through 1435790000.

Table with columns: Order No., Type, Page. Contains 10 rows of product data.

1440000000

Table with columns: Order No., Type, Page. Contains 5 rows of product data.

1460000000

Table with columns: Order No., Type, Page. Contains 6 rows of product data.

1470000000

Table with columns: Order No., Type, Page. Contains 2 rows of product data.

1480000000

Table with columns: Order No., Type, Page. Contains 7 rows of product data.

1490000000

Table with columns: Order No., Type, Page. Contains 47 rows of product data.

1500000000

Table with columns: Order No., Type, Page. Contains 33 rows of product data.

Table with columns: Order No., Type, Page. Contains 10 rows of product data.

Table with columns: Order No., Type, Page. Contains 47 rows of product data.

1510000000

Table with columns: Order No., Type, Page. Contains 2 rows of product data.

1520000000

Table with columns: Order No., Type, Page. Contains 2 rows of product data.

1530000000

Table with columns: Order No., Type, Page. Contains 3 rows of product data.

1560000000

Table with columns: Order No., Type, Page. Contains 31 rows of product data.

Table with columns: Order No., Type, Page. Contains 4 rows of product data.

1600000000

Table with columns: Order No., Type, Page. Contains 51 rows of product data.

1610000000

Table with columns: Order No., Type, Page. Contains 1 row of product data.

1650000000

Table with columns: Order No., Type, Page. Contains 25 rows of product data.

Table with columns: Order No., Type, Page. Contains 10 rows of product data.

Table with columns: Order No., Type, Page. Contains 51 rows of product data.

Order No.	Type	Page
2749320000	SDS 0.4X2.5X75	J.34
2749330000	SDS 0.5X3.0X80	J.34
2749340000	SDS 0.6X3.5X100	J.34
2749350000	SDS 0.6X3.5X200	J.34
2749360000	SDS 0.8X4.0X100	J.34
2749370000	SDS 0.8X4.5X125	J.34
2749380000	SDS 1.0X5.5X150	J.34
2749390000	SDS 1.2X6.5X150	J.34
2749400000	SDK PH0 X 60	J.34
2749410000	SDK PH1 X 80	J.34
2749420000	SDK PH2 X 100	J.34
2749430000	SDK PH3 X 150	J.34
2749440000	SDK PZ1 X 80	J.34
2749450000	SDK PZ2 X 100	J.34
2749460000	SDK PZ3 X 150	J.34
2749470000	SD T7 TR X 60	J.34
2749480000	SD T8 TR X 60	J.34
2749490000	SD T9 TR X 60	J.34
2749500000	SD T10 TR X 80	J.34
2749510000	SD T15 TR X 80	J.34
2749520000	SD T20 TR X 100	J.34
2749530000	SD T25 TR X 100	J.34
2749540000	SD T30 TR X 115	J.34
2749550000	SD T40 TR X 115	J.34
2749560000	SD TO 0.6X3,0	J.34
2749570000	SD TO 0.4X2,5	J.34

2750000000

2750060000	SD EL 0.3X1.5X40 PICO	J.36
2750070000	SD EL 0.4X2.0X60 PICO	J.36
2750080000	SD EL 0.4X2.5X75 PICO	J.36
2750090000	SD EL 0.5X3.0X75 PICO	J.36
2750100000	SD EL 0.6X3.5X100 PICO	J.36
2750110000	SD EL 0.8X4.0X100 PICO	J.36
2750120000	SDK EL P20 X 60 PICO	J.36
2750130000	SDK EL P21 X 80 PICO	J.36
2750140000	SDK EL PH0 X 60 PICO	J.36
2750150000	SDK EL PH1 X 80 PICO	J.36
2750160000	SD EL SET 1.5-4.0/PH0/1	J.36

2770000000

2772780000	HDC MHX 3 MP	C.25
2772790000	HDC MHX 3 FP	C.25
2772800000	HDC MHX 4 MP	C.23
2772810000	HDC MHX 4 FP	C.23

2780000000

2780770000	HDC GRIP PANEL 3 ADAPT COM	J.19
2780780000	HDC GRIP PANEL 4 ADAPT COM	J.19
2780790000	HDC GRIP PANEL 6 ADAPT COM	J.19
2780800000	HDC GRIP PANEL 8 ADAPT COM	J.19
2782940000	HDC GRIP PANEL 3 COM	J.19
2782950000	HDC GRIP PANEL 4 COM	J.19
2782970000	HDC GRIP PANEL 6 COM	J.19
2782980000	HDC GRIP PANEL 8 COM	J.19
2784920000	VB 8.0X20 BK	J.51
2784930000	VB 7.0X25 BK	J.51
2784940000	VGM32-MS65 4X7 SL	J.51
2784950000	VGM32-MS65 4X8 SL	J.51
2784960000	VGM32-MS65 3X7.6 SL	J.51
2784970000	VGM32-MS65 3X6.7 SL	J.51

8000000000

8000015137	HDC FBS TOOL 13-50	H.8
8000015137	HDC FBS TOOL 13-50	H.13

9000000000

9003750000	M-D-STRIPAX LWL	J.31
9004530000	DW RSV 1.6	J.38
9008850000	SK WSD-S 1.5-10.0	J.37
9008860000	SKS 2.0-8.0	J.37
9008870000	SKS 2.0-8.0 MR	J.37
9008880000	TH-S 9-40	J.37

9010000000

9010950000	HTX-HDC/POF	J.11
9010950000	HTX-HDC/POF	J.31
9011990000	HTX 188	C.45
9011990000	HTX 188	J.5
9012410000	HTG 174	C.45
9012410000	HTG 174	J.5
9013690000	CTX CM 1.6/2.5 ZERT	J.29
9018480000	CTX CM 3.6	J.6
9018480000	CTX CM 3.6	J.29
9018490000	CTX CM 1.6/2.5	B.10
9018490000	CTX CM 1.6/2.5	B.12
9018490000	CTX CM 1.6/2.5	B.14
9018490000	CTX CM 1.6/2.5	B.16
9018490000	CTX CM 1.6/2.5	B.20
9018490000	CTX CM 1.6/2.5	B.22
9018490000	CTX CM 1.6/2.5	B.24
9018490000	CTX CM 1.6/2.5	B.26
9018490000	CTX CM 1.6/2.5	B.28

Order No.	Type	Page
9018490000	CTX CM 1.6/2.5	B.30
9018490000	CTX CM 1.6/2.5	B.34
9018490000	CTX CM 1.6/2.5	B.36
9018490000	CTX CM 1.6/2.5	B.38
9018490000	CTX CM 1.6/2.5	B.40
9018490000	CTX CM 1.6/2.5	B.42
9018490000	CTX CM 1.6/2.5	B.46
9018490000	CTX CM 1.6/2.5	B.48
9018490000	CTX CM 1.6/2.5	B.52
9018490000	CTX CM 1.6/2.5	B.54
9018490000	CTX CM 1.6/2.5	B.56
9018490000	CTX CM 1.6/2.5	B.58
9018490000	CTX CM 1.6/2.5	B.60
9018490000	CTX CM 1.6/2.5	B.62
9018490000	CTX CM 1.6/2.5	B.64
9018490000	CTX CM 1.6/2.5	B.66
9018490000	CTX CM 1.6/2.5	B.68
9018490000	CTX CM 1.6/2.5	B.72
9018490000	CTX CM 1.6/2.5	B.74
9018490000	CTX CM 1.6/2.5	B.76
9018490000	CTX CM 1.6/2.5	B.78
9018490000	CTX CM 1.6/2.5	B.80
9018490000	CTX CM 1.6/2.5	B.82
9018490000	CTX CM 1.6/2.5	B.100
9018490000	CTX CM 1.6/2.5	B.102
9018490000	CTX CM 1.6/2.5	B.104
9018490000	CTX CM 1.6/2.5	B.106
9018490000	CTX CM 1.6/2.5	B.108
9018490000	CTX CM 1.6/2.5	B.110
9018490000	CTX CM 1.6/2.5	B.112
9018490000	CTX CM 1.6/2.5	B.128
9018490000	CTX CM 1.6/2.5	C.17
9018490000	CTX CM 1.6/2.5	C.26
9018490000	CTX CM 1.6/2.5	C.27
9018490000	CTX CM 1.6/2.5	C.29
9018490000	CTX CM 1.6/2.5	C.31
9018490000	CTX CM 1.6/2.5	C.38
9018490000	CTX CM 1.6/2.5	C.39
9018490000	CTX CM 1.6/2.5	C.40
9018490000	CTX CM 1.6/2.5	J.4
9018490000	CTX CM 1.6/2.5	J.6
9018490000	CTX CM 1.6/2.5	J.29

9020000000

9020360000	AM LWL/POF	J.11
9020360000	AM LWL/POF	J.31
9020390000	PS LWL/POF	J.11
9020390000	PS LWL/POF	J.31
9020400000	PB LWL/POF	J.11
9020400000	PB LWL/POF	J.31

9200000000

9202510000	WK 1/4 C8,3 E6,3	J.32
9204820000	KOK-52X36	J.28
9204830000	KOK-65X36	J.28
9204850000	KOK-86X36	J.28
9204870000	KOK-112X36	J.28
9205000000	KOHS 9.5+19	J.28
9205010000	KOHS 19	J.28
9205020000	KOPD 10.0	J.28
9205430000	CTIN CM 1.6/2.5	B.100
9205430000	CTIN CM 1.6/2.5	B.102
9205430000	CTIN CM 1.6/2.5	B.104
9205430000	CTIN CM 1.6/2.5	B.106
9205430000	CTIN CM 1.6/2.5	B.108
9205430000	CTIN CM 1.6/2.5	B.110
9205430000	CTIN CM 1.6/2.5	B.118
9205430000	CTIN CM 1.6/2.5	B.124
9205430000	CTIN CM 1.6/2.5	B.128
9205430000	CTIN CM 1.6/2.5	C.17
9205430000	CTIN CM 1.6/2.5	C.20
9205430000	CTIN CM 1.6/2.5	C.22
9205430000	CTIN CM 1.6/2.5	C.24
9205430000	CTIN CM 1.6/2.5	C.26
9205430000	CTIN CM 1.6/2.5	C.27
9205430000	CTIN CM 1.6/2.5	C.28
9205430000	CTIN CM 1.6/2.5	C.29
9205430000	CTIN CM 1.6/2.5	C.31
9205430000	CTIN CM 1.6/2.5	C.38
9205430000	CTIN CM 1.6/2.5	C.39
9205430000	CTIN CM 1.6/2.5	C.40
9205430000	CTIN CM 1.6/2.5	J.4
9205430000	CTIN CM 1.6/2.5	J.6
9205440000	CTIN CM 3.6	J.29

9450000000

9457300000	ABD-1-STAHBLECH	J.25
------------	-----------------	------

9910000000

9918370000	DMS MANUELL 0,5-1,7	J.32
9918380000	DMS MANUELL 2,0-7,0	J.32
9918390000	DMSI MANUELL 0,5-1,7	J.33

Order No.	Type	Page
9918400000	DMSI MANUELL 2,0-7,0	J.33
9918520000	WK S 0.4X2.5	J.32
9918530000	WK S 0.5X3.0	J.32
9918540000	WK S 0.6X3.5	J.32
9918550000	WK S 0.8X4.0	J.32
9918560000	WK S 1.0X5.5	J.32
9918570000	WK K PH0	J.32
9918580000	WK K PH1	J.32
9918590000	WK K PH2	J.32
9918600000	WK K PZ0	J.32
9918610000	WK K PZ1	J.32
9918620000	WK K PZ2	J.32

Addresses worldwide

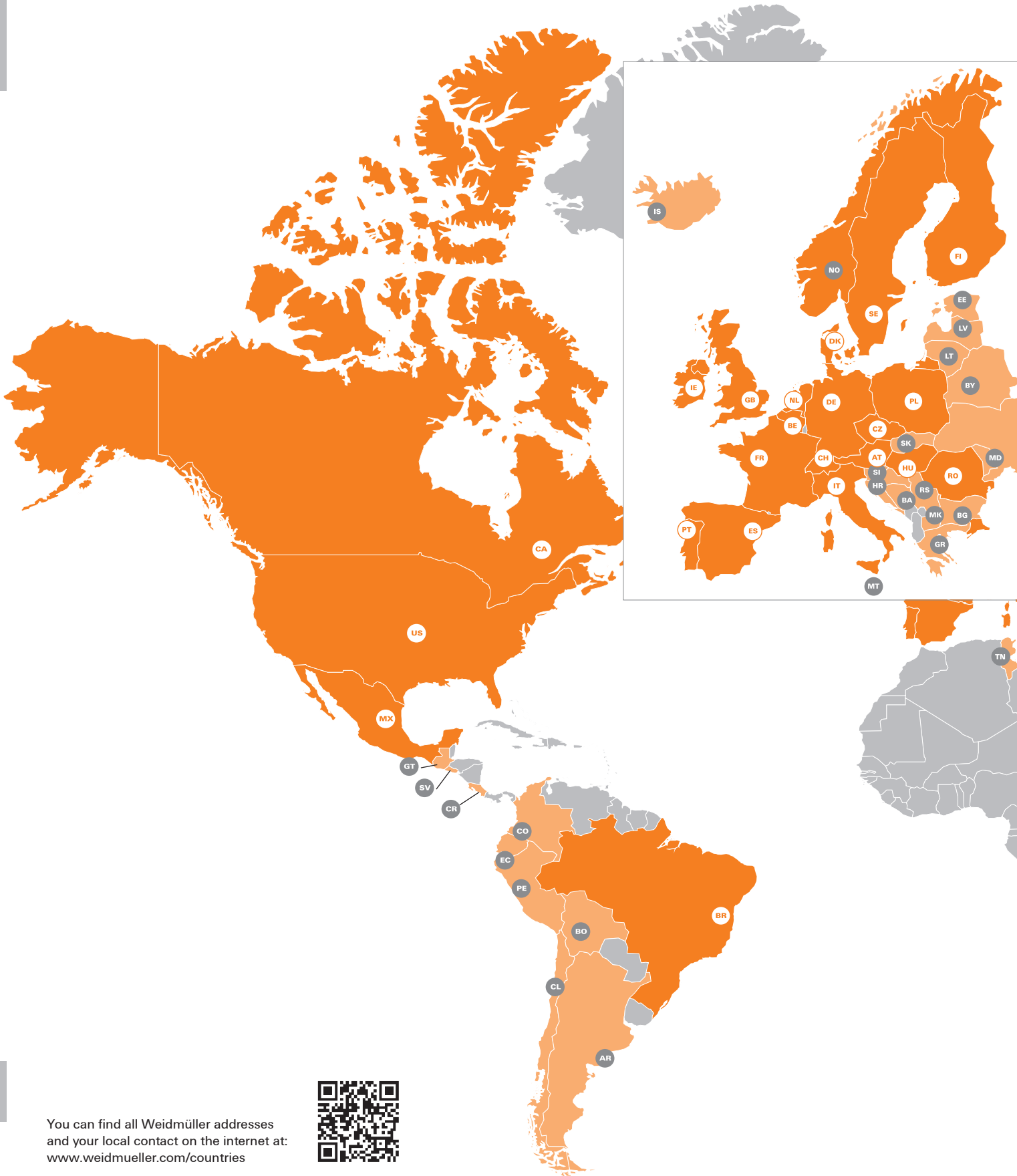

X

You can find all Weidmüller addresses and your local contact on the internet at: www.weidmueller.com/countries



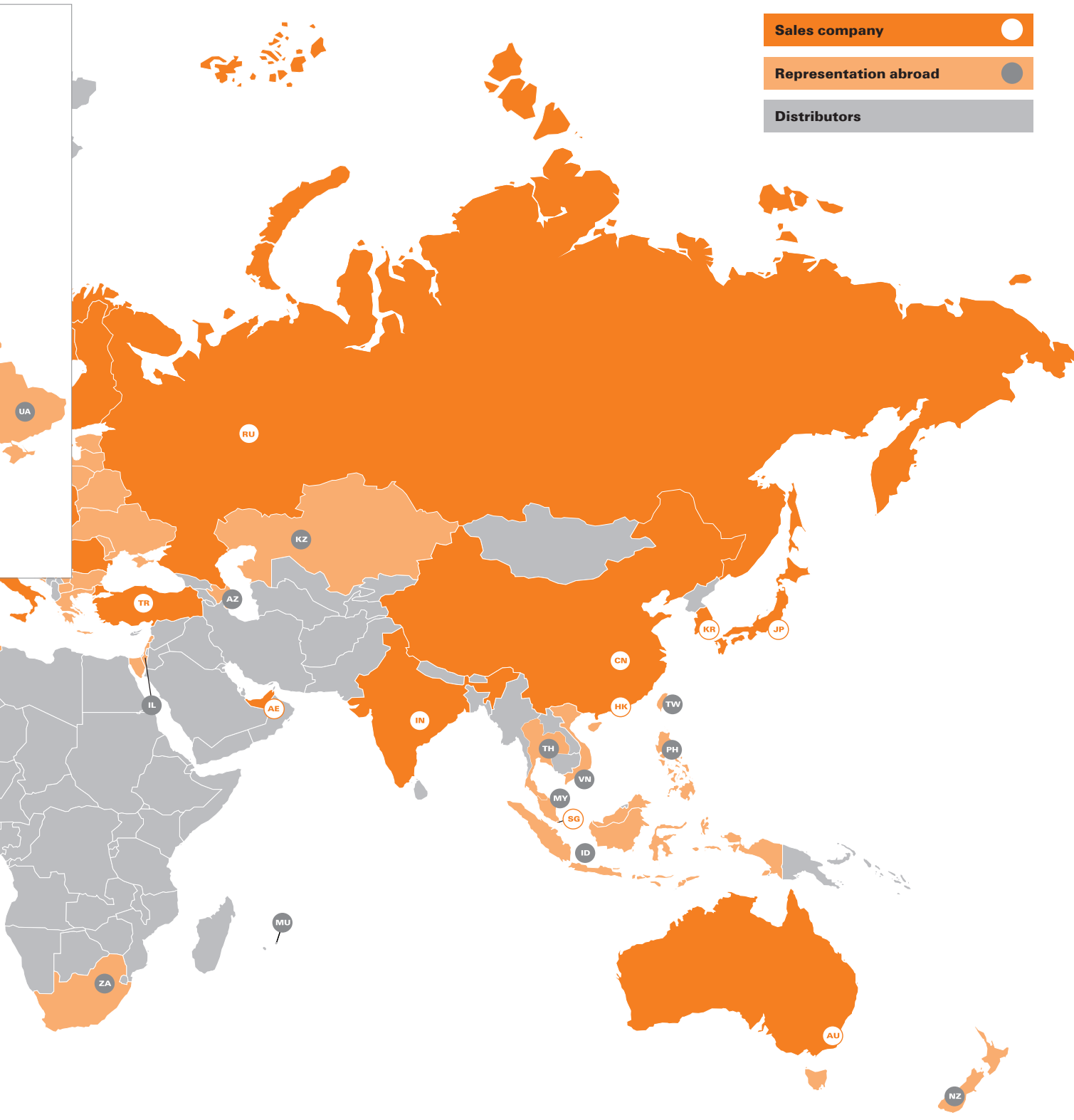

We cannot guarantee that there are no mistakes in the publications or software provided by us to the customer for the purpose of making orders. We try our best to quickly correct errors in our printed media.

X

All orders are based on our general terms of delivery, which can be reviewed on the websites of our group companies where you place your order. On demand we can also send the general terms of delivery to you.

Weidmüller – Your partner in Industrial Connectivity

As experienced experts we support our customers and partners around the world with products, solutions and services in the industrial environment of power, signal and data. We are at home in their industries and markets and know the technological challenges of tomorrow. We are therefore continuously developing innovative, sustainable and useful solutions for their individual needs. Together we set standards in Industrial Connectivity.

Weidmüller Interface GmbH & Co. KG
Klingenbergstraße 26
32758 Detmold, Germany
T +49 5231 14-0
F +49 5231 14-292083
www.weidmueller.com

Personal support can
be found on our website:
www.weidmueller.com/contact

Made in Germany



Order Number: 2864040000/06/2022/SMD